



# **DCD CHAOYANG DIESEL ENGINE**

**Operation & Maintenance manual**

**Model 100 102 105 series**

**DONGFENG CHAOYANG DIESEL ENGINE CO. LTD**

## **Foreword**

**Dongfeng Chaoyang Diesel Engine Co., Ltd was built in 1960, the original name is Chaoyang Agricultural Machine Factory, and it lies old city - Chaoyang in west of Liaoning. It mainly produced agricultural machine spare parts and agricultural machine test equipments. In 1973, it began to produce agricultural diesel engine, so it changed the name into Chaoyang Diesel Engine Factory. On April 26, 1993, it joined Dongfeng Automobile CORP. (Short: DFAC), so it is a wholly owned subsidiary company OF DFAC. It changed name into Dongfeng Chaoyang Diesel Engine Corporation. In September, 2001, it carried out debt changing shares, so it established Dongfeng Chaoyang Diesel engine Co., LTD. (Short: DCD.). After more than 40 years developing, DCD has been important backbone enterprise which China fixed to produce vehicle diesel engine—China large-scale and second-grade enterprise.**

**In 1979, DCD developed China first high-speed direct-injection vehicle diesel engine –6102Q model engine. After more than 20 years, at present the products are 4100, 4102, 4105, 6102, 6105, 6110, QD32 seven series, including natural-inspiration, super-charge,**

inter-cooling supercharge, it is nearly two hundred versions. Now it can equipped with diesel engines for DFAC, Hefei Jianghui Automobile Co., Ltd. and Nanchong Automobile Corp. and so on more than 100 automobile manufacture enterprises. Our products are with compact, light - weight, powerful, energy-saving, low noise and emission and so on, all emission index reached Euro I standard, some of products can reach II standard, and it is awarded “green power”. Recent years, DCD 4102, 4105 series diesel engines depended on performance and quality, becoming the first choice power of every automobile factory, and exported or exported with automobiles Burma, Thailand, Phillipine, Sri Lanka, Turkey and so on more than 20 countries and areas. Under DCD there are 25 offices and spare parts transition stores with more than 669 service agents all over the country and 24 hours "initiative, rapid, effective" on time and high quality service is available for customers. In 1997, DCD officially passed ISO9001 Quality system certificate, and realized quality management joint international standard. DCD “CY” trademark is famous trademark of Liaoning Province, and was commented as **"completed contracts with faith " of the first national five hundred enterprise.**

In order to exert sufficiently DCD’s machine excellent quality, and let customers satisfy, so we edited the maintenance manual for

supplying sale persons, and let them know about and master the product's technical characteristic and apply, and for maintenance and service persons supply the product knowledge and maintenance technology learning and training, and when maintenance and repairing, it also can be referenced for customers.

The manual covered 100, 102, and 105 series, and it is with 4100Q、4100ZLQ、4102Q、4102BQ、4102BG、4102BZQ、4102BZLQ、4102EZLQ、6102Q、6102AQ、6102BQ、6102B<sub>1</sub>Q、6102G、6102G<sub>1</sub>、6102G<sub>2</sub>、6102BG<sub>1</sub>、6102BZQ、6102BZLQ、4105Q、6105Q and so on twenty-one basal model products.

**The main contents of the manual:**

---Diesel engine basic structure and function

---Diesel engine performance parameter and performance curve

---The technical specification, assorting with dimension and tighten moment of the main spare parts

---The diesel engine disassembly, repair technology

---Operation and maintenance of the diesel engine

---Ordinary troubles and shooting of diesel engine

---Matching requirement for diesel engine and automobile

The data and explanation which the manual supplied depending on the existing the products. With the technology developing and according to the customer's requirement, the configuration will

continue to perfect. So some contents may be unconformity future productions, and please customers notice and if there are some problems, you may send letter to DCD or land DCD web by network.

## **Catalogue**

### **Chapter 1 Summary**

- 1. The name of diesel engine appearance and every spare parts**
- 2. The main technical parameter of diesel engine**
- 3. The brief introduction of the main spare parts and system for diesel engine**
- 4. The performance curve of diesel engine**

### **Chapter 2 The technical specification, assorting with dimension and tighten moment of the main spare parts**

- 1. Engine**
- 2. Engine and inner component**
- 3. Cylinder-head and component**
- 4. Additional parts technical specification**

### **Chapter 3 The diesel engine disassembly, repair technology**

- 1. Symbol and meaning**
- 2. Disassemble of outer spare parts**
- 3. Disassemble of inner spare parts**

- 4. Disassemble of basic spare parts**
- 5. Disassembly of interference concerting parts**
- 6. The check of basic parts**
- 7. Disassembly, repair and adjustment of additional parts**

#### **Chapter 4 The operation and maintenance of diesel engine**

- 1. The choice of diesel oil, oil and coolant**
- 2. The criterion of normal operation**
- 3. The criterion of maintenance**

#### **Chapter 5 Ordinary troubles and shooting of diesel engine**

- 1. Causes and symptom and influence of every system**
- 2. Integrate diagnosis and shooting of diesel engine**

#### **Chapter 6 Matching requirement between diesel engine and automobile**

- 1. Diesel engine collocation on the automobile**
- 2. Cooling of diesel engine**
- 3. Inlet of diesel engine**
- 4. Power matching for diesel engine and automobile**

## CHAPTER 1 Summary

The names of diesel engine appearance and every spare parts

(sample: 4102Q diesel engine)

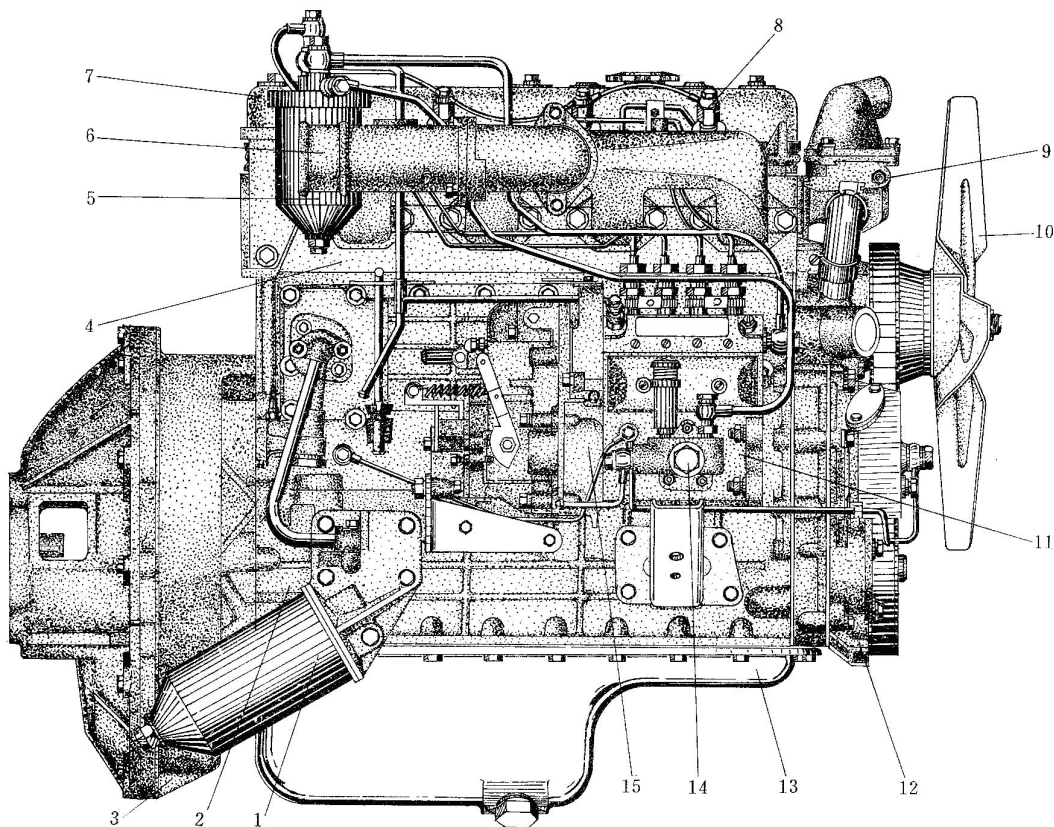

- |                |                         |                        |                  |
|----------------|-------------------------|------------------------|------------------|
| 1. Oil filter  | 2. Engine               | 3. Flywheel case       | 4. Cylinder-head |
| 5. Fuel filter | 6. inlet pipe           | 7. Cylinder-head cover | 8. Injector      |
| 9. Thermostat  | 10. Fan                 | 11. Injection pump     | 12. Gear chamber |
| 13. Oil sump   | 14. Supply pump         | 15. Governor           | 16. Generator    |
| 17. Dipstick   | 18. Breathing apparatus | 19. Exhaust pipe       |                  |
| 20. Starter    | 21. Clutch case         |                        |                  |

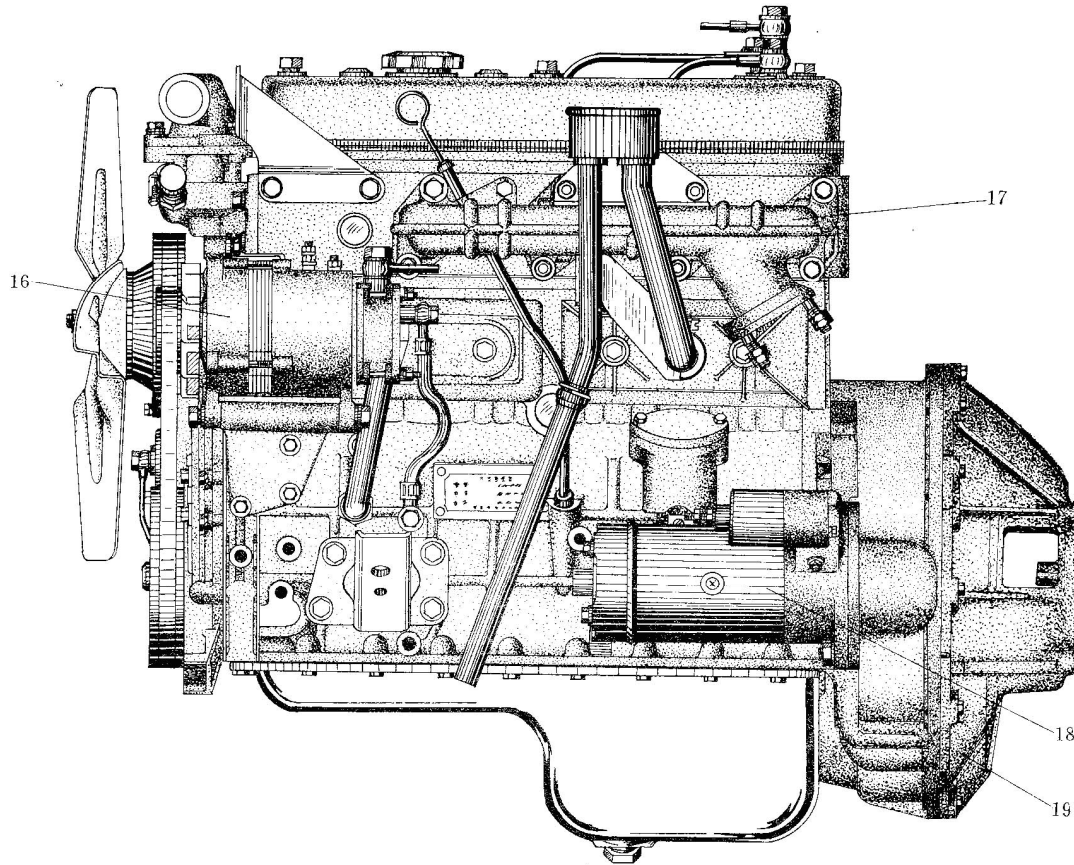

## **The main technical parameter of diesel engine**

**The main technical parameter of diesel engine is in the diesel engine general situation table (1), (2), (3) which DCD produced 100, 102, 105 diesel engine.**



**The general situation table of diesel engine operation (1)**

|   |   |  |
|---|---|--|
| <b>Model</b>                            | 100、102、105series diesel engine   |  |
| <b>Type</b>                             | 6102BZQ 、 4102BZQ 、 4102BZQ<br>environment-protection 、 4102BZLQ 、<br>4102BZLQ-A 、 4100ZLQ 、 4102EZL 、<br>6102BZLQ、 | Vertical, in-line, water-cool, four-strokes<br>turbo-charge and inter-cooling turbo-charge |
| <b>Combustion chamber</b>               | The others non-turbo-charge   | Vertical, in-line, water-cool, four-strokes  |
| <b>Cylinder-sleeve</b>                  | Direction injection square combustion chamber ( circle beading combustion chamber<br>for inter-cooling engine )     |  |
| <b>Firing order</b>                     | Four-cylinder   | 1-3-4-2  |
| <b>Rotation direction of crankshaft</b> | Six-cylinder  | 1-5-3-6-2-4  |
| <b>Starting model</b>                   | Counter clockwise   |  |
| <b>Lubrication model</b>                | Electricity   |  |
| <b>Shut down mode of engine</b>         | Forced and splash<br>Switch off of supply oil   |  |

**The general situation table of diesel engine operation ( 2 )**

| Item                                | Model  | 4102Q | 4102BQ | 4102BG | 4102BZQ    | 6102Q  | 6102AQ | 6102BQ | 6102B1Q | 6102G | 6102G1 | 6102G2 | 6102BG | 6102BG1 | 6102BZQ   | 4105Q | 6105Q |
|-------------------------------------|--------|-------|--------|--------|------------|--------|--------|--------|---------|-------|--------|--------|--------|---------|-----------|-------|-------|
| Stroke ( mm )                       |        | 100   | 118    | 118    | 118        | 110    | 110    | 118    | 118     | 110   | 110    | 110    | 1118   | 118     | 118       | 118   | 118   |
| Displacement(L)                     |        | 3.268 | 3.856  | 3.856  | 3.856      | 5.395  | 5.393  | 5.785  | 5.785   | 5.393 | 5.393  | 5.393  | 5.785  | 3.785   | 5.785     | 4.087 | 6.131 |
| Compression ratio                   |        | 17    | 17.5   | 17.5   | 16.5       | 17.5   | 17.5   | 17.5   | 17.5    | 17.5  | 17.5   | 17.5   | 17.5   | 17      | 16.5      | 17.5  | 17.5  |
| Rated power (Kw)                    |        | 62.5  | 70.6   | 49.0   | 88.0       | 88.2   | 95.5   | 103    | 110     | 81.0  | 59.0   | 66.0   | 81.0   | 70.0    | 120       | 74.0  | 106.6 |
| Rated speed(r/min)                  |        | 3500  | 3200   | 2300   | 2800       | 2800   | 3000   | 3000   | 3200    | 2800  | 2200   | 2500   | 2500   | 2300    | 2800      | 3000  | 3000  |
| Max torque (N.m)                    |        | 201   | 245    | 235    | 345        | 333    | 343    | 372    | 382     | 318   | 284    | 289    | 353    | 343     | 460       | 265   | 402   |
| Max torque speed (r/min)            |        | 2200  | 2200   | 1600   | 1400~1800  | 1960   | 2000   | 2000   | 2000    | 1960  | 1650   | 1900   | 1650   | 1650    | 1400~1800 | 2000  | 1800  |
| Full load min. consumption (g/Kw.h) |        | 238.0 | 238.0  | 238.0  | 224.4      | 231.2  | 231.2  | 231.2  | 228.5   | 231.2 | 231.2  | 232    | 231.2  | 232     | 220.0     | 231.2 | 224.4 |
| Min idle steady speed (r/min)       |        | ≤650  | ≤650   | ≤650   | ≤750       | ≤650   | ≤650   | ≤650   | ≤650    | ≤650  | ≤650   | ≤650   | ≤650   | ≤650    | ≤750      | ≤700  | ≤700  |
| Max. idle steady speed (r/min)      |        | 〈3850 | 〈3250  | 〈2530  | 〈3180~3220 | 〈3080  | 〈3300  | 〈3300  | 〈3520   | 〈3080 | 〈2420  | 〈2750  | 〈2750  | 〈2530   | 〈3080     | 〈3300 | 〈3300 |
| Net weight (kg)                     |        | 320   | 330    | 330    | 340        | 480    | 480    | 480    | 480     | 480   | 480    | 480    | 480    | 480     | 495       | 330   | 480   |
| Overall dimensions (mm)             | Length | 806   | 806    | 790    | 790        | 1260.5 | 1220   | 1220   | 1151    | 1113  | 1073   | 1113   | 113    | 113     | 1240      | 790   | 1220  |
|                                     | width  | 660   | 660    | 620    | 660        | 773    | 640    | 640    | 751     | 700   | 662    | 700    | 700    | 700     | 700       | 660   | 640   |
|                                     | Height | 750   | 750    | 750    | 813        | 940    | 1020   | 1020   | 809     | 1008  | 850    | 1008   | 1008   | 1008    | 970       | 750   | 1020  |

**The general situation table of diesel engine operation ( 3 )**

| Item                                | Model  | 4100Q          | 4100ZLQ     | 4102BZLQ-A  | 4102BZQ<br>environment-protection | 4102BZLQ    | 4102EZLQ    | 6102BZLQ            |
|-------------------------------------|--------|----------------|-------------|-------------|-----------------------------------|-------------|-------------|---------------------|
| stroke ( mm )                       |        | 118            | 118         | 118         | 118                               | 118         | 118         | 118                 |
| displacement(L)                     |        | 3.707          | 3.707       | 3.856       | 3.856                             | 3.856       | 3.856       | 5.785               |
| Compression ratio                   |        | 17.5           | 17.5        | 17          | 17                                | 17          | 17.5        | 17                  |
| Rated power(Kw)                     |        | 66、62.5、 64    | 70/81       | 88          | 88                                | 103         | 103         | 132/120/107/114     |
| Rated speed(r/min)                  |        | 3200、2800、3000 | 3200        | 2800        | 2800                              | 2800        | 2800        | 2600/2800/2800/2800 |
| Max torque (N.m)                    |        | 230            | 235/310     | 343         | 343                               | 392         | > 392       | 560/480/420/431     |
| Max torque speed (r/min)            |        | 1800 ~ 2000    | 1800 ~ 2000 | 1600 ~ 1800 | 1400 ~ 1800                       | 1400 ~ 1800 | 1400 ~ 1800 | 1400 ~ 1800         |
| Full load min. consumption (g/Kw.h) |        | ≤ 218          | ≤ 220       | ≤ 225       | ≤ 225                             | ≤ 205       | ≤ 210       | ≤ 220               |
| Min idle steady speed (r/min)       |        | ≤ 750          | ≤ 750       | ≤ 750       | ≤ 750                             | ≤ 750       | ≤ 750       | 700 ~ 750           |
| Max. idle steady speed (r/min)      |        | ≤ 3080         | ≤ 3600      | 3220        | 3220                              | 3220        | ≤ 3220      | 3220                |
| Net weight(kg)                      |        | 320            | 340         | 350         | 350                               | 350         | 350         | 550                 |
| Overall dimensions (mm)             | Length | 879            | 791         | 963.1       | 963.1                             | 963.1       | 963.1       | 1209.7              |
|                                     | width  | 662            | 694         | 693         | 693                               | 693         | 693         | 662                 |
|                                     | Height | 765            | 755         | 820.8       | 820.8                             | 820.8       | 820.8       | 884.5               |

## **The brief introduction of the main spare parts & system for diesel engine**

**Diesel engine is complicated machine that it is made of many framework and system. Commonly it includes cylinder-block assembly, cylinder-head assembly, crank-lever and connect-rod, air distribution, fuel supply system, lubrication system, cooling system and other assistant system.**

***Cylinder-block and cylinder head*----they are the main frame, all movement parts and assistant system are installed their body. In their body there are cavities, holes and cooling water and lubrication oil can flow from them. And it also cast air passage for inlet and exhaust on the cylinder head. Cylinder-block adopted straddle and dry bush.**

***Crank-lever & connect-rod*---its function is: it makes straight -line motion of piston in cylinder-block change rotation motion of crankshaft, and makes fuel pressure on piston change torque of crankshaft, then output chassis of automobile. Crank-lever & connect-rod include piston assembly, connect-rod assembly, crankshaft flywheel assembly and so on.**

***Air distribution*—according to the requirement, and timing eliminate exhaust gas and suck fresh air. It is made up valve assembly, running (including timing gear, camshaft, tappet, push lever, rocker**

arm shaft and rocker arm and so on.), inlet and outlet pipe, and filter. And turbo-charge diesel engine is with a booster. Its power comes from timing gear joggled active gear on the front of crankshaft and brought camshaft rotation at crankshaft half speed.

*Fuel supply system*--- according to the certain requirements, and timing, fix quantify injected fuel into combustion chamber with higher pressure, and ensured fuel and air can quickly mix and meet needing of combustion process. Its working will effect performance of diesel engine. Fuel supply system is made of fuel box (installing on the vehicles, engine itself without it.), delivery pump, diesel filter, injection pump, governor, injection automatic advancer, high and low pressure oil pipe and injector.

*Lubrication system*—its function is: It makes lubrication oil send to friction surface of all motion spare parts and concerned position, it is with reducing wearing, cooling, purifying, sealing and antirust function, and so it ensured normal work of diesel engine and prolong using life. It is mainly made up lubrication passage and valve on oil sump, oil pump assembly, oil filter and cylinder-block. On non turbo-charge engine, lubrication system sends oil into every friction surface, but on booster it also has an oil injection nozzle to inject piston bottom for cooling piston.

*Cooling system* ----its function is: It makes superabundance

heating transmit which heating parts absorbed in order to ensure temperature normal not over warm or over cold when diesel engine is working, and effect diesel engine normal working. The series diesel engine adopted forced closed cycle cooling water system, and it is made of radiator, fan, water pump, thermostat, cylinder-block and cooling water bush in cylinder-head.

*Other assistant system*—included starting, generating electricity and brake system. Starting by starter, it made diesel engine under outside force from stillness to fixed speed, and so it realized firing combustion and changed into automatic running. Starter is installed the back of diesel engine, and it is near gear ring, once it is connected with 24v electrical source, starter will drive gear insert the gear ring and so bring flywheel running. And on diesel engine it is also installed magnetic-electric generator, belt gear in front of the main shaft by belt drives, and it can supply electricity for working engine, and superabundance electricity stored accumulator on vehicle. On the six cylinders engine, it is with air pump for vehicle braking, and it can supply compress air to braking system on vehicle.

# Diesel engine performance curve

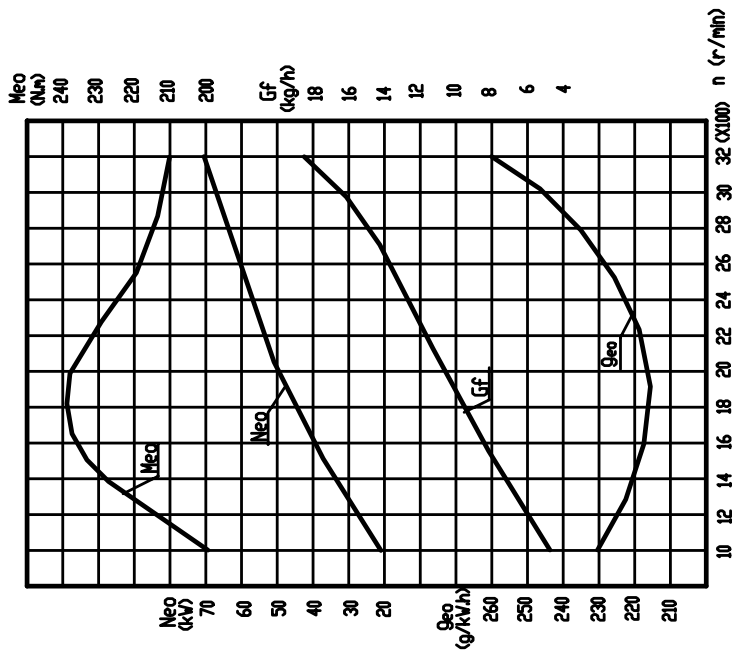

Full speed and full load performance curve

of model 4100Q diesel engine

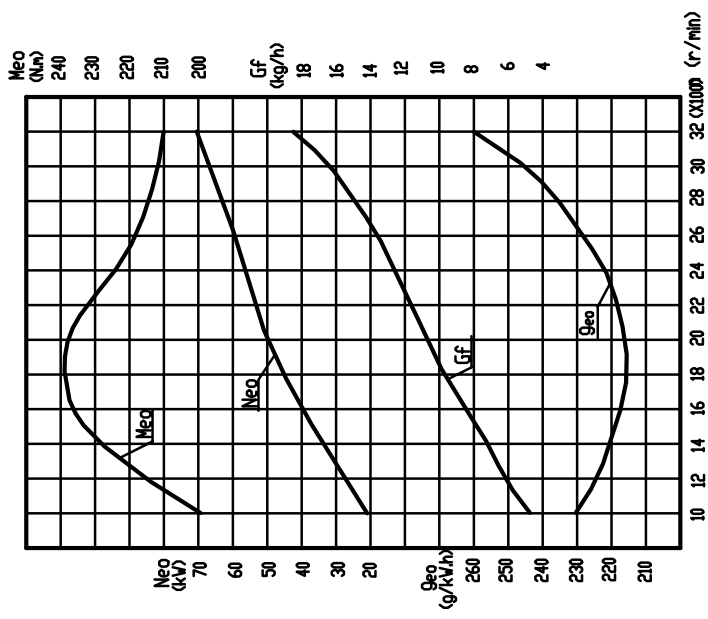

Full speed and full load performance curve of model

CY4100ZLQ diesel engine

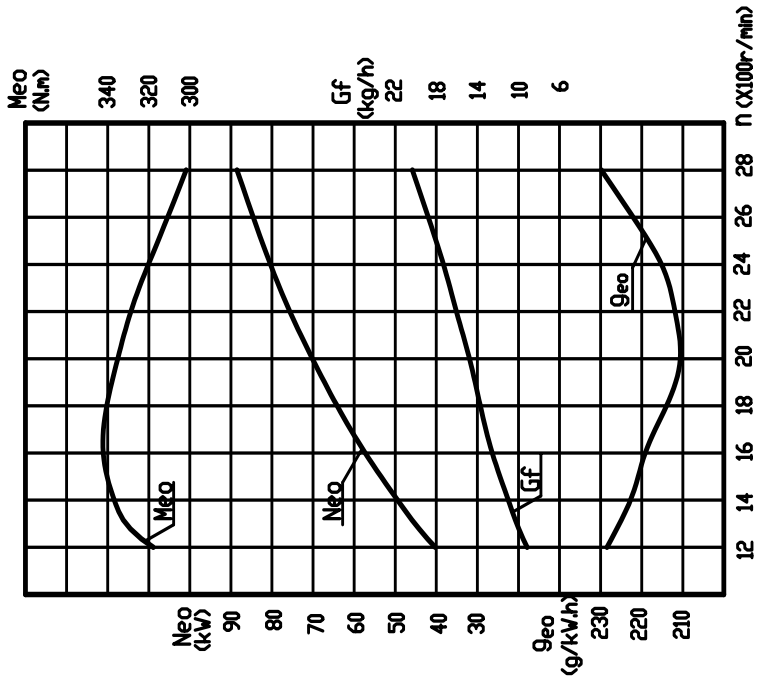

Full speed and full load performance curve

of model 4102BZLQ –A diesel engine

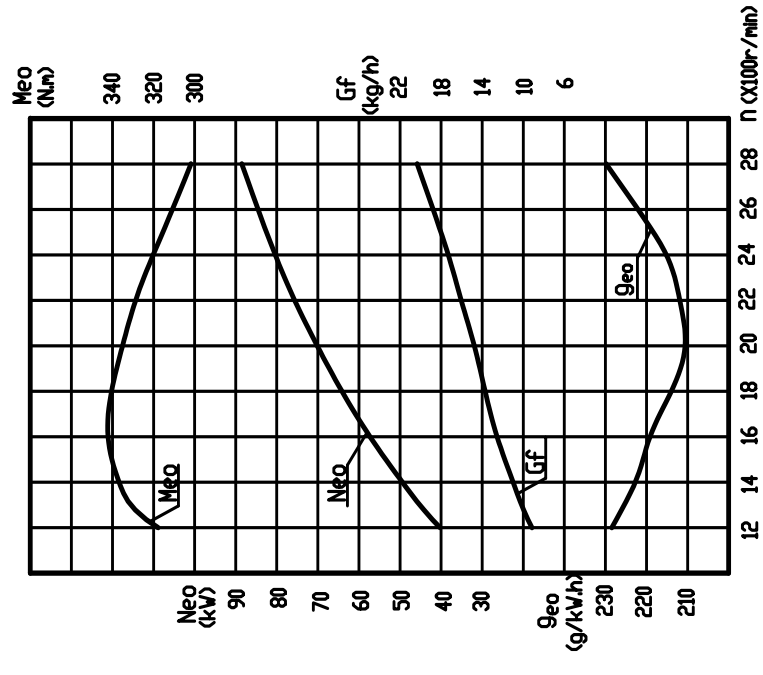

Full speed and full load performance curve of model

4102BZQ environment protection diesel engine



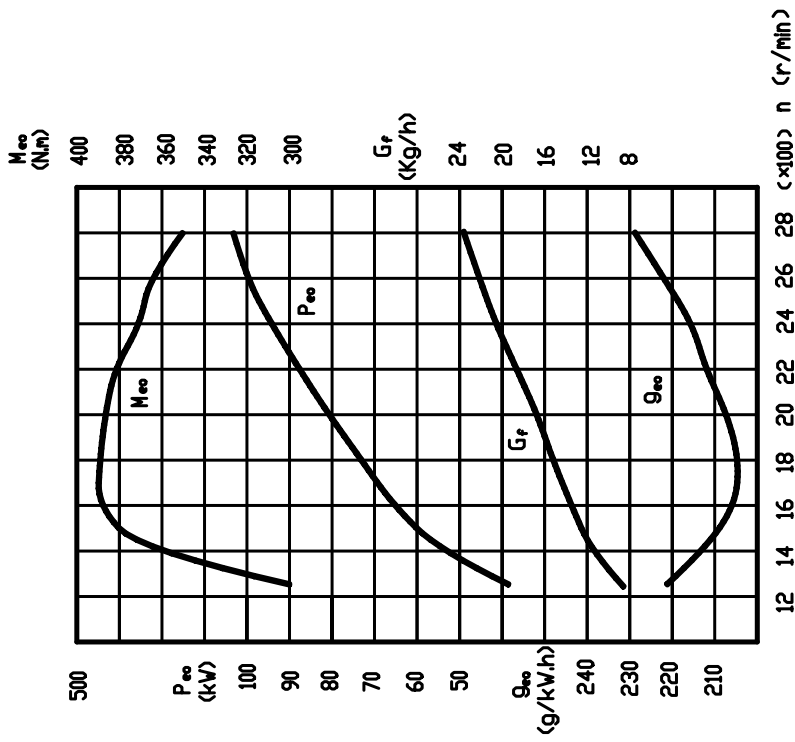

Full speed and full load performance curve

of model CY4102EZLQdiesel engine

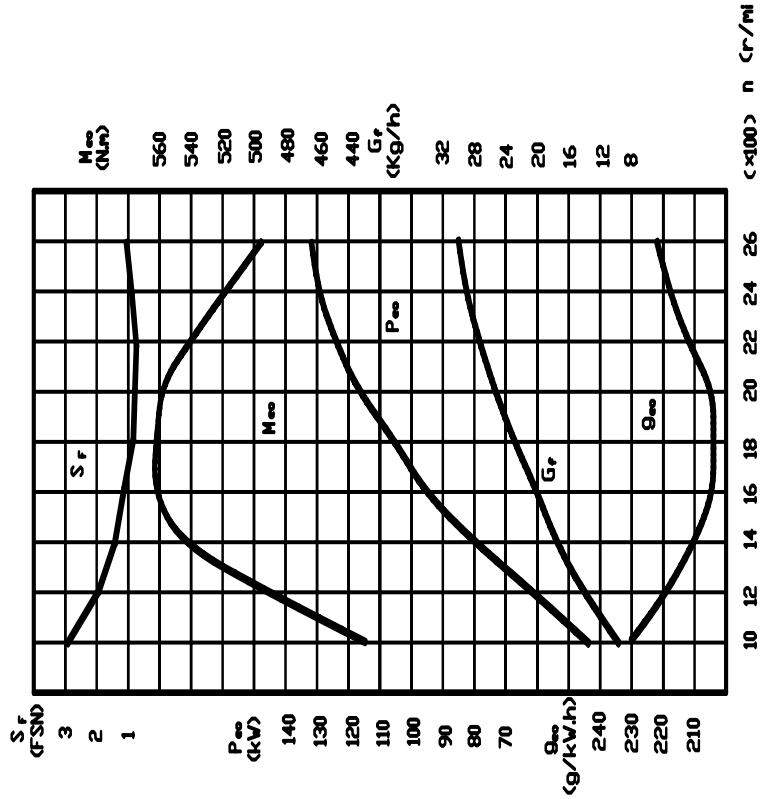

Full speed and full load performance curve

of model CY6102BZLQdiesel engine

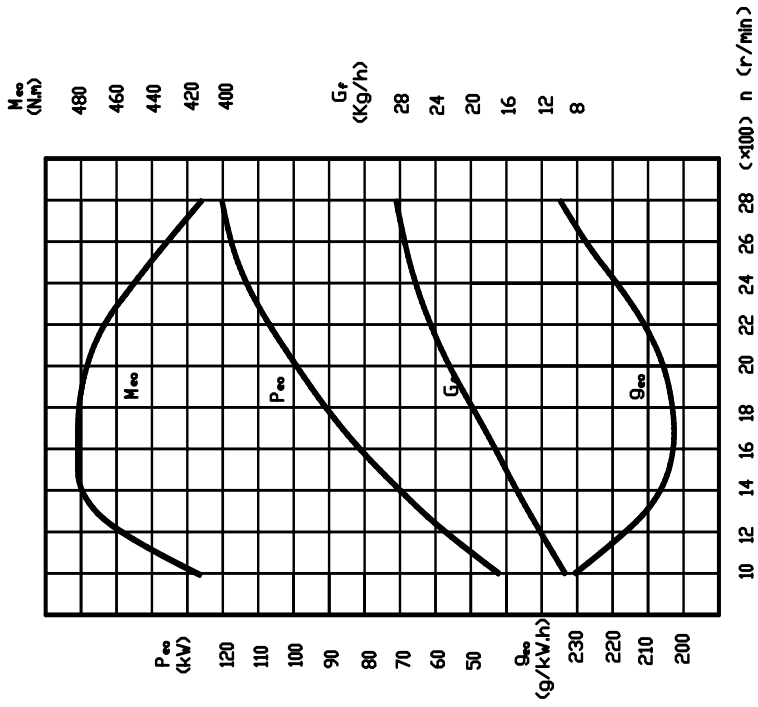

**Full speed and full load performance curve of model CY6102BZLQ-A diesel engine**

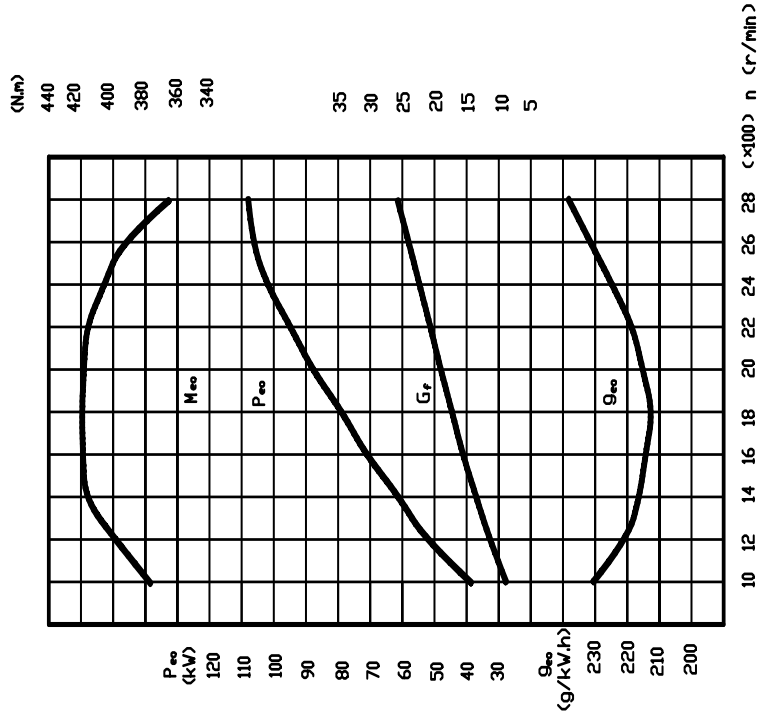

**Full speed and full load performance curve of model CY6102BZLQ-B diesel engine**

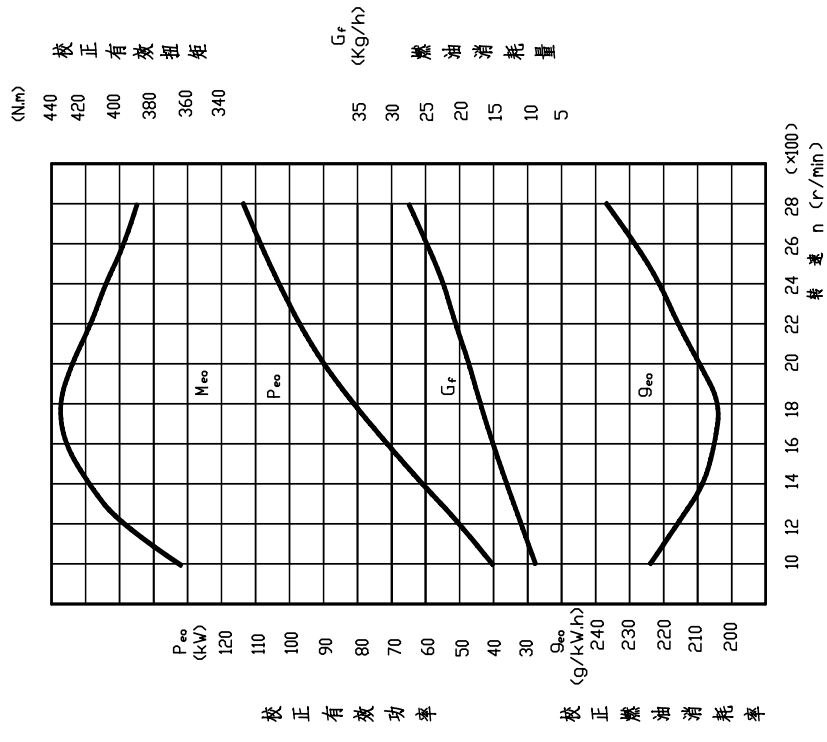

Full speed and full load performance curve

of model CY6102BZLQ-W diesel engine

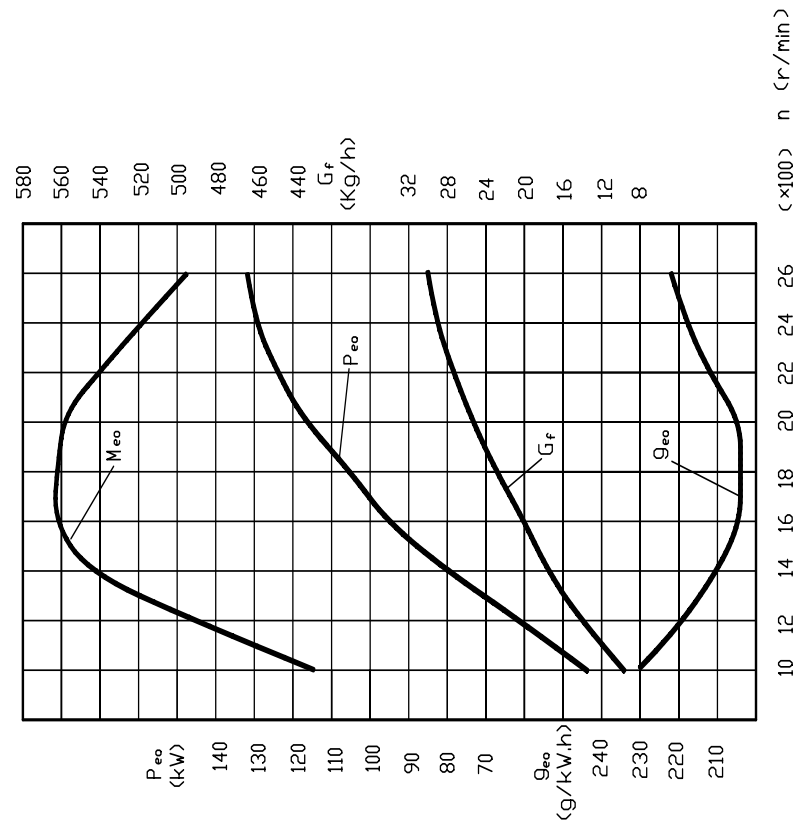

Full speed and full load performance curve

of model CY6102BZLQ-C diesel engine

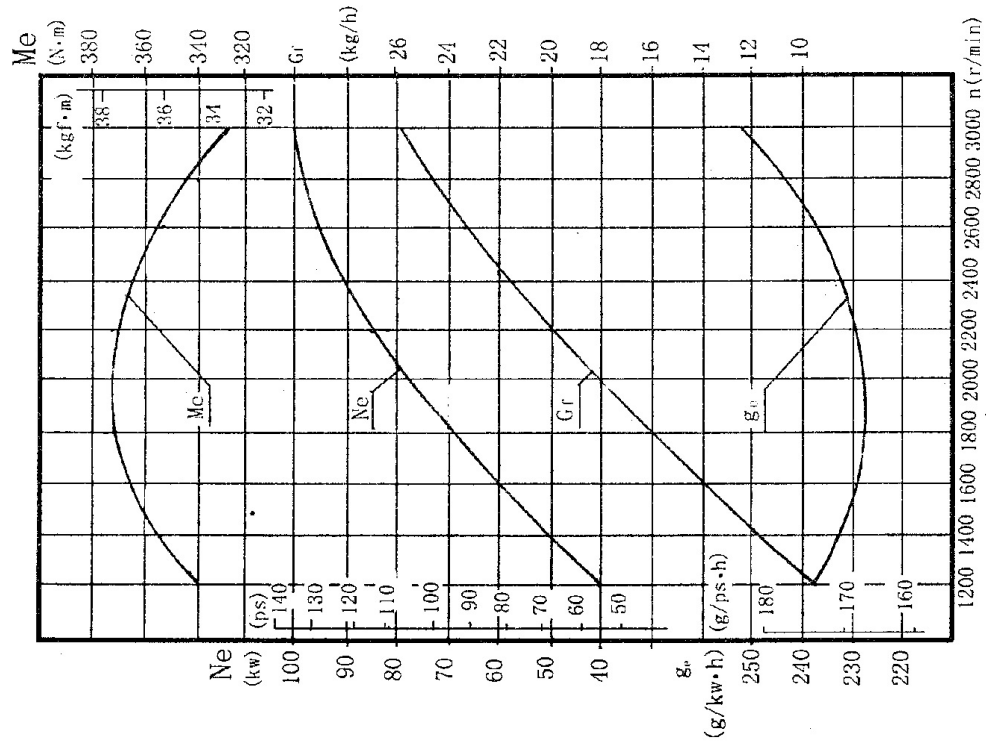

FULL speed and full load performance curve of model 6102BQ diesel engine

(Ordinary booster)

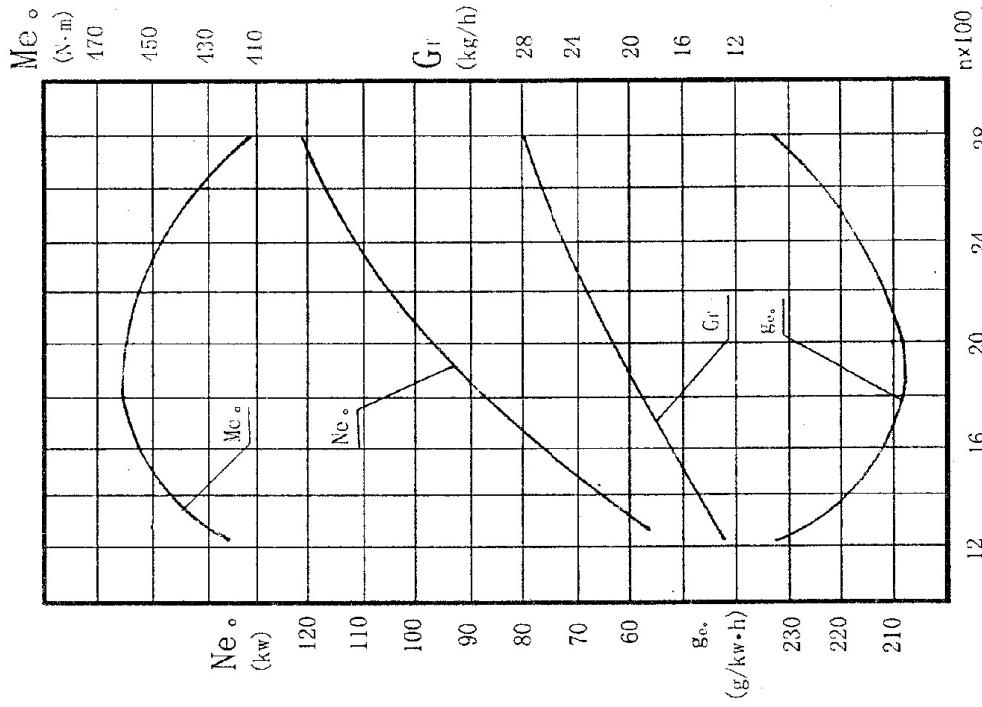

FULL speed and full load performance curve of model 6102BZQ diesel engine

(Ordinary booster)

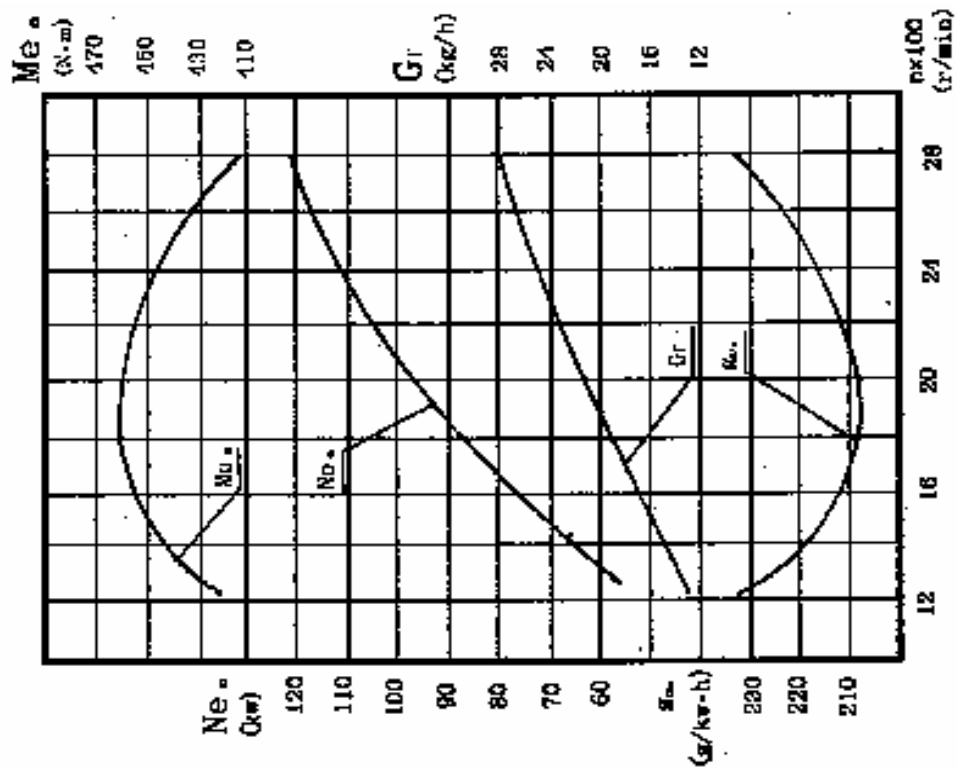

Full load performance curve of modle 6105Q diesel engine

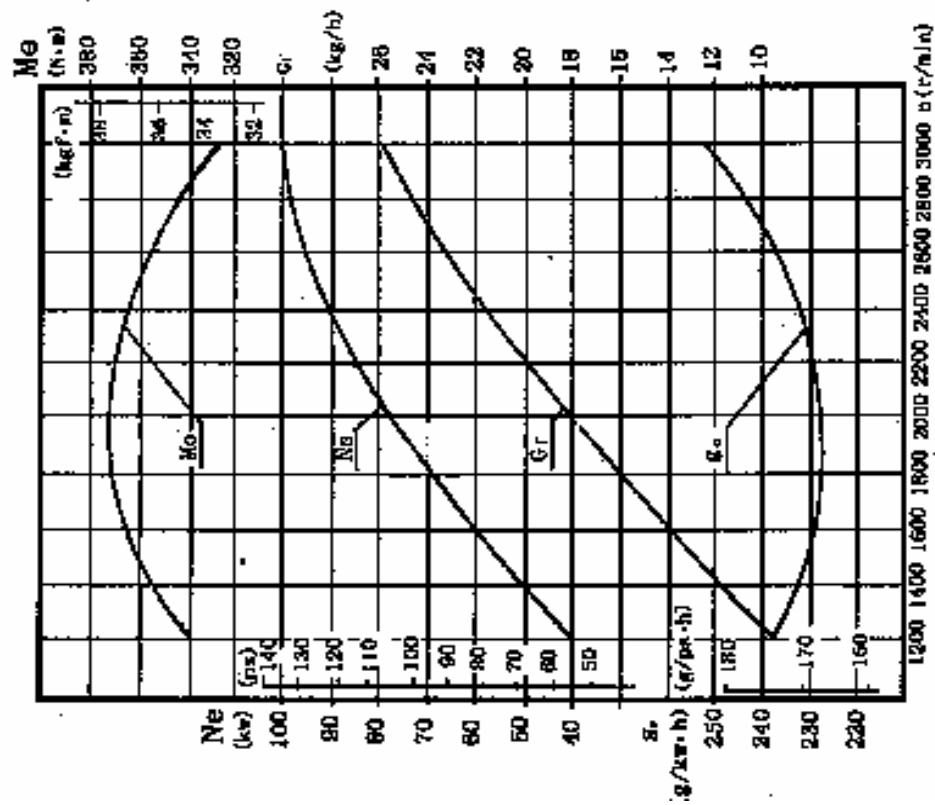

Full load performance curve of modle 4105Q diesel engine

## Chapter2 The technical specification, assorting with dimension and tighten moment of the main spare parts

### 1. The engine

| Item  |                | Basic standard      | Repair/wear limit |  | Remark   |
|---|----------------|---------------------|-------------------|--|--|
| Max. idling speed (r/min)   |                | <110% rated speed   |                   |  | Oil 70~80℃                                     |
| Idling **   |                | Speed (r/min)       | ≤650              |  | Steady running                                 |
|   |                | Oil pressure        | ≥78               |  | Oil 70~80℃                                     |
| Valve timing ***  | Intake valve   | Opening             | Before T.D.C 14°  |  | According to the crankshaft rotation angle     |
|   |                | Closing             | After B.D.C 50°   |  |  |
|   | Exhaust valve  | Opening             | Before B.D.C 56°  |  |  |
|   |                | Closing             | After T.D.C 16°   |  |  |
| Valve clearance (inlet, exhaust) (mm)   |                | 0.4                 | <0.3<br>>0.4      |  | Cold status                                    |
| Static state supply advance angle   |                | Detail see page 28. |                   |  | crankshaft rotation angle                      |
| Cylinder compress (MPa)   | Every cylinder | >2.8                | <2.0              |  | When warming engine, its speed is 180~220r/min |
|   | Max.—Min.      | <0.4                |                   |  |  |
| Compress interference (The distance between T.D.C piston and bottom of cylinder-head, mm) |                | 0.9~1.1             |                   |  |  |

\* **Repairing:** After restored and adjusted, it can reach requirements. **Wear:** Can't repair, and must replace. But when the limit of repairing and wearing are the same with basic standards, we will not list again, the following tables are the same.

\*\* Turbo-charge, inter-cooling turbo-charge  $\leq 750$  r/min.

\*\*\* Model 4102EZL Valve timing: Inlet valve opening: before T.D.C  $18.5^\circ$  . Inlet valve closed: after B.D.C 40.5. Exhaust valve opening: before B.D.C  $71.7^\circ$  . Exhaust valve closed: after T.D.C  $23.7^\circ$

## 2.Cylinder-block and inner subassembly

### 2.1 Assembly basic standard

unit: (mm)

| No. | Item  | Basic standard                            |                                       |  | Repair/repair limit                      | Remark  |
|-----|---|---|---------------------------------------|--|--|---|
|     |   | 100 series                                | 102 series                            | 105series                                |  |   |
| 1   | Inner diameter of cylinder bush             | $\phi 105.000$<br>~ $\phi$<br>105.030     | $\phi 105.000$<br>~ $\phi$<br>105.030 | $\phi$<br>108.000<br>~ $\phi$<br>108.030 |  | Interference Matching<br>-0.010~-0.030,<br>Divided into three groups, the same group matched. |
|     | Outer diameter of cylinder bush (a)         | $\phi 105.020$<br>~ $\phi$<br>105.050     | $\phi 105.020$<br>~ $\phi$<br>105.050 | $\phi$<br>108.020<br>~ $\phi$<br>108.050 |  |   |
| 2   | Shoulder concave depth of cylinder bush     | 4.00~4.04 (matching steel bush:1.30~1.34) |                                       |  |  | Protrude height 0.05~0.12   |
|     | Shoulder concave thickness of cylinder bush | 4.09~4.12(steel bush:1.39~1.42)           |                                       |  |  |   |
| 3   | Inner diameter of cylinder bush             | $\phi 100.020$<br>~ $\phi$<br>100.060     | $\phi 102.020$<br>~ $\phi$<br>102.060 | $\phi$<br>105.020<br>~ $\phi$<br>105.060 | $\phi 100.2, \phi 102.2$<br>$\phi 105.2$ | Clearance Matching<br>0.18~-0.20<br>Divided into four groups, the same group matched.         |
|     | Piston skirt big diameter(b)                | $\phi 99.830$<br>~ $\phi$<br>99.870       | $\phi 101.830$<br>~ $\phi$<br>101.870 | $\phi$<br>104.830<br>~ $\phi$<br>104.870 |  |   |
| 4   | Piston pin hole inner diameter              | $\phi 34.995 \sim \phi 35.007$            |                                       |  |  | Clearance Matching<br>0.001 ~ 0.010,  |

|      |   |  |                   |   |
|------|---|--|-------------------|---|
|      | Piston pin inner diameter               | $\phi 34.991 \sim \phi 35.000$   |                   | Divided into three groups, the same group matched.                            |
| 5    | Inner diameter of connect rod bush      | $\phi 35^{+0.030}_{+0.015}$  | Clearance<br>0.07 | Clearance Matching<br>0.015~0.039   |
|      | Piston pin diameter                     | $\phi 35^0_{-0.009}$   |                   |   |
| 6(c) | The first piston ring slot width        | $3^{+0.10}_{+0.08}$  | Clearance<br>0.20 | Clearance Matching<br>0.08~0.115  |
|      | The first piston ring slot thickness    | $3^0_{-0.015}$   |                   |   |
| 7(d) | The second piston ring slot width       | $2.5^{+0.05}_{+0.03}$  | Clearance<br>0.15 | Clearance Matching<br>0.03~0.065  |
|      | The second piston ring slot thickness   | $2.5^0_{-0.015}$   |                   |   |
| 8(e) | Oil ring slot width                     | $5^{+0.05}_{+0.03}$  | Clearance<br>0.15 | Clearance Matching<br>0.03~0.065  |
|      | Oil ring thickness                      | $5^0_{-0.015}$   |                   |   |
| 9    | Inner diameter of camshaft bush         | $\phi 56^{+0.03}_0$  | Clearance<br>0.15 | Clearance Matching<br>Four-cylinder<br>0.03~0.09<br>Six cylinder<br>0.06~0.12 |
|      | The axis diameter of camshaft           | Four cylinder $\phi 56^{-0.03}_{-0.06}$ Six cylinder $\phi 56^{-0.06}_{-0.09}$ |                   |   |
| 10   | Orientation diameter length of camshaft | $5^{+0.078}_{+0.030}$  | Clearance<br>0.25 | Clearance Matching<br>0.09~0.168  |
|      | Thrust thickness of camshaft            | $5^{-0.06}_{-0.09}$  |                   |   |



| No.       | Item                                 | Basic standard              |           |           | Repair/wear limit                          | Remark  |
|-----------|--------------------------------------|-----------------------------|-----------|-----------|--|---|
|           |                                      | 100series                   | 102series | 105series |  |   |
| 11        | Inner diameter of tappet hole        | $\phi 28_{0}^{+0.021}$      |           |           | Clearance<br>0.15                          | Clearance matching<br>0.040~0.082   |
|           | Excircle diameter of tappet          | $\phi 28_{-0.061}^{-0.040}$ |           |           |  |   |
| 12        | Inner diameter of idler axis bush    | $\phi 45_{0}^{+0.025}$      |           |           | Clearance<br>0.2                           | Clearance matching<br>0.025~0.075   |
|           | Diameter of idler axis               | $\phi 45_{-0.050}^{-0.025}$ |           |           |  |   |
| 13        | Orientation length of idler axis     | $26_{0}^{+0.052}$           |           |           | Clearance<br>0.25                          | Clearance matching<br>0.065~0.169   |
|           | Idler thickness                      | $26_{-0.117}^{-0.065}$      |           |           |  |   |
| 14<br>(f) | Inner diameter of the main axis hole | $\phi 85_{0}^{+0.022}$      |           |           | Clearance<br>Between axis and tile is 0.15 | Crankshaft permits wearing 0.5, 1.0, here axis tile increasing 0.25, 0.5. |
|           | The main shell thickness             | $2.5_{0}^{+0.010}$          |           |           |  |   |
|           | The main axis diameter of crankshaft | $\phi 80_{-0.084}^{-0.065}$ |           |           |  |   |
| 15        | The fourth main shaft width          | $34_{0}^{+0.039}$           |           |           | Clearance<br>0.4                           | Axial clearance is<br>0.115~0.256   |
|           | Thrust thickness                     | $2.5_{-0.050}^{-0.025}$     |           |           |  |   |
|           | The fourth main bearing seat width   | $29_{-0.117}^{-0.065}$      |           |           |  |   |

|    |   |                             |   |   |
|----|---|-----------------------------|---|---|
| 16 | Connect rod big-end hole inner diameter         | $\phi 68_{0}^{+0.019}$      | Clearance Between axis and tile is 0.15 | It can repair connect-rod axis diameter |
|    | Connect rod bearing bush thickness              | $2_{0}^{+0.010}$            |   |   |
|    | Axis diameter of crankshaft connect rod         | $\phi 64_{-0.079}^{-0.060}$ |   |   |
| 17 | Opening clearance of the first piston ring (g)  | 0.30~0.50                   | 1.5                                     | When it is installed in cylinder-block  |
| 18 | Opening clearance of the second piston ring (h) | 0.20~0.40                   | 1.5                                     | When it is installed in cylinder-block  |
| 19 | Opening clearance of oil ring (i)               | 0.20~0.40                   | 1.5                                     | When it is installed cylinder-block     |
| 20 | Backlash between crankshaft gear and idler gear | 0.10~0.18                   | 0.35                                    |   |
| 21 | Backlash between camshaft and idler gear        | 0.12~0.21                   | 0.35                                    |   |
| 22 | Backlash between injection pump and idler gear  | 0.12~0.21                   | 0.35                                    |   |

(a) 102 series turbo-charge engine adopted steel cylinder bush, and the outer diameter is  $\phi 105.010 \sim \phi 105.040$ , interference Matching is  $-0.020 \sim 0$ 。

Outer diameter of 100 series finished product cylinder bush  $\phi$  105.010 $\sim$  $\phi$  105.040, interference Matching -0.020 $\sim$ 0.

(b) Piston skirt big diameter of 102 series turbo-charge engine is 101.890 $\sim$ 101.930, clearance matching is 0.12 $\sim$ 0.14.

Piston skirt big diameter of 4102Q is 101.940 $\sim$ 101.980, clearance diameter is 0.07 $\sim$ 0.09.

(c) The first piston ring slot width of 4102EZLQ is  $2.97 \pm 0.01$ , and the first piston ring slot thickness is  $2.889_0^{+0.02}$ , clearance matching is 0.089 $\sim$ 0.091.

(d) The second piston ring slot width is  $2.5_{+0.05}^{+0.07}$ , The second piston ring slot thickness  $2.5_{-0.015}^0$ , clearance matching is 0.05 $\sim$ 0.085.

(e) Oil ring slot width is  $4_{+0.03}^{+0.05}$ , Oil ring slot thickness  $4_{-0.015}^0$ , clearance matching 0.030 $\sim$ 0.065.

(f) The main shaft diameter of 4102Q is  $\phi 76_{-0.084}^{-0.065}$ , bearing bush thickness is  $2.5 \pm 0.0075$ , the main shaft hole inner diameter is  $\phi 81_0^{+0.022}$ , limit clearance between axis and shell 0.15.

(g) The first ring opening clearance of 102 series turbo-charge engine is 0.25 $\sim$ 0.45.

(h) The second ring opening clearance of 4102EZL is 0.45 $\sim$ 0.65.

(i) Opening clearance of 100 series oil ring is 0.25 $\sim$ 0.45.

## 2.2 Tighten data

| Item                                | Wring moment(N ·m) | Remark  |
|-------------------------------------|--------------------|---|
| The main bearing screw              | 216~235            |   |
| Connect rod screw                   | 118~127            |   |
| Flywheel screw                      | 186~206            | Natural aspirate                              |
|                                     | 196~216            | Turbo-charge<br>turbo-charge<br>inter cooling |
| Flywheel screw                      | 127~147            |   |
| Gear press screw of camshaft        | 108~118            |   |
| Nut on the end of crankshaft        | 392~441            | Four cylinders                                |
|                                     | 588~637            | Six cylinders                                 |
| Equalizer valve of the main gallery | 29~39              |   |
| Drain oil screw of oil sump         | 70~90              |   |
| The other thread tighten parts      | M6                 | 4~6   |
|                                     | M8                 | 18~23   |
|                                     | M10                | 32~42   |
|                                     | M12                | 55~70   |
|                                     | M14                | 90~110  |
|                                     | M16                | 140~170                                       |

### 3. Cylinder-head & subassembly

#### 3.1 Assembly basic standard

| No.                                       | Item  | Basic standard                    | Wear limit  | remark  |
|---|---|-----------------------------------|---|---|
| 1   | Guide pipe hole inner diameter of cylinder head                 | $\phi 14_{0}^{+0.018}$            |   | Interference matching   |
|   | Outer diameter of valve guide pipe                              | $\phi 14_{+0.028}^{+0.039}$       |   |   |
| 2   | Inner diameter of inlet valve seat hole for cylinder-head       | $\phi 47_{0}^{+0.025}$            |   | Interference matching   |
|   | Outer diameter of inlet valve seat                              | $\phi 47_{+0.054}^{+0.079}$       |   |   |
| 3   | Exhaust valve seat inner diameter of cylinder-head              | $\phi 39_{0}^{+0.025}$            |   | Interference matching   |
|   | Exhaust valve seat outer diameter                               | $\phi 39_{+0.048}^{+0.073}$       |   |   |
| 4   | Inner diameter of valve guide pipe                              | $\phi 9_{0}^{+0.022}$             | Limit clearance:<br>Inlet valve 0.20<br>Exhaust valve<br>0.25 | Clearance matching:<br>Inlet valve 0.025 ~ 0.069<br>exhaust valve 0.040~0.084 |
|   | Diameter of inlet valve   | $\phi 9_{-0.047}^{-0.025}$        |   |   |
|   | Diameter of exhaust valve                                       | $\phi 9_{-0.062}^{-0.040}$        |   |   |
| 5   | Inner diameter of rocker-arm bush                               | $\phi 20_{+0.020}^{+0.041}$       | $\phi 20.06$  | Clearance matching<br>0.02 ~ 0.061 , limit<br>0.20                            |
|   | Outer diameter of rock-arm shaft                                | $\phi 20_{-0.02}^0$               | $\phi 19.86$  |   |
|   | Inner diameter of rocker-arm seat hole                          | Front $\phi 20_{-0.010}^{+0.010}$ |   |   |
| Middle 、 rear $\phi 20_{+0.007}^{+0.028}$ |   |                                   |   |   |
| 6   | Valve guide pipe is higher than spring surface of cylinder-head | $14.5_{0}^{+0.5}$                 |   |   |
| 7   | Inlet and exhaust valve sink                                    | 0.8~1.1                           | 2.5   |   |

### 3.2 Tighten data

| Item                               | Wring moment<br>(N • m) | Remark                                      |
|------------------------------------|-------------------------|---|
| Cylinder-head screw                | 108~118                 | Natural aspirate                            |
|                                    | 118~127                 | Turbo-charge \turbo-charge<br>inter cooling |
| Cylinder-head cover<br>fixed screw | 8~10                    |   |

### 4. Appendix technical specification

|                       |   |
|-----------------------|---|
| <b>Air filter</b>     | <b>Cyclone dust collecting paper type</b>   |
| <b>Supercharger</b>   | <b>Radial EGR (with or without relief valve)</b>  |
| <b>Oil pump</b>       | <b>Gear type</b>  |
| <b>Oil filter</b>     | <b>full-flow</b>  |
| <b>Oil cooler</b>     | <b>Water cooling, inner, plate case</b>   |
| <b>Water pump</b>     | <b>Vane centrifugal</b>   |
| <b>Thermostat</b>     | <b>Wax type, the beginning opening at 76°C, complete opening at 86°C</b>  |
| <b>Fan</b>            | <b>spindle-flow, four~ seven vanes</b>  |
| <b>Injection pump</b> | <b>Bosch A type, AD reinforce pump, P pump, VE pump and so on. Plunger diameter see operation manuals of every model engines.</b> |
| <b>Injector</b>       | <b>Length closed, 4-6 holes, injection-hole diameter and opening injection pressure see operation</b>                             |

manuals of every model engines.

**Delivery pump**      **piston**

**Governor**            **Full-speed or two-stage mechanical**

**Supply oil automatic advancer**      **Mechanical centrifugal built-in**

**Fuel filter**            **Single tin or double tins paper filter element**

**Starter**                **Electric control 12V/24V, 3.7kW or 4.5kW**

**Generator**            **Silicon controlled rectifier 28V, 500W or 1000W**

**Brake air compressor**

**Piston type, single or two cylinder water-cool or  
air cool**















**Vacuum pump**      **vanes type**

**\*Different engine model, different manufacture times, different  
matching vehicle, every accessories model are with multiplicity, so we  
can't list one by one.**

# Chapter 3 Disassembly & repairing technology of diesel engine

6102 diesel engine is a sample for disassembly of diesel engine

## Indication symbol and meaning

|             |   |                         |   |
|-------------|---|-------------------------|---|
| Disassembly |    | view and check          |    |
| Install     |    | Measurement             |    |
| Dissolve    |  | Washing                 |  |
| Reassembly  |  | Note                    |  |
| Direction   |  | Tighten                 |  |
| Revise      |  | Lubrication with oil    |  |
| Adjustment  |  | Lubrication with grease |  |



## **二、 Outside parts disassembly and assembly**

### **Outside parts disassembly**

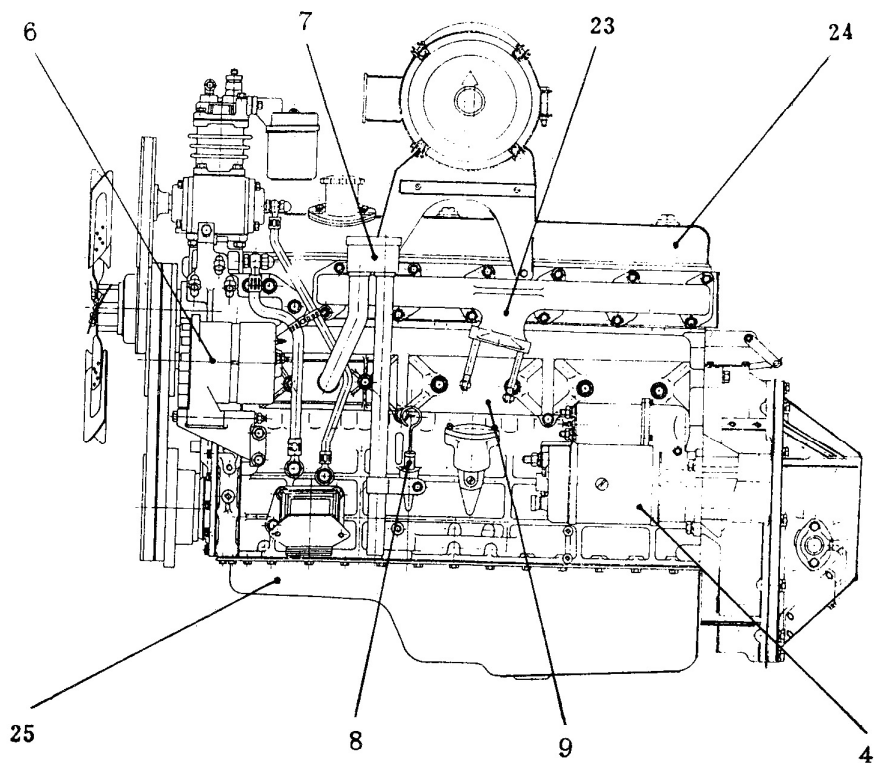
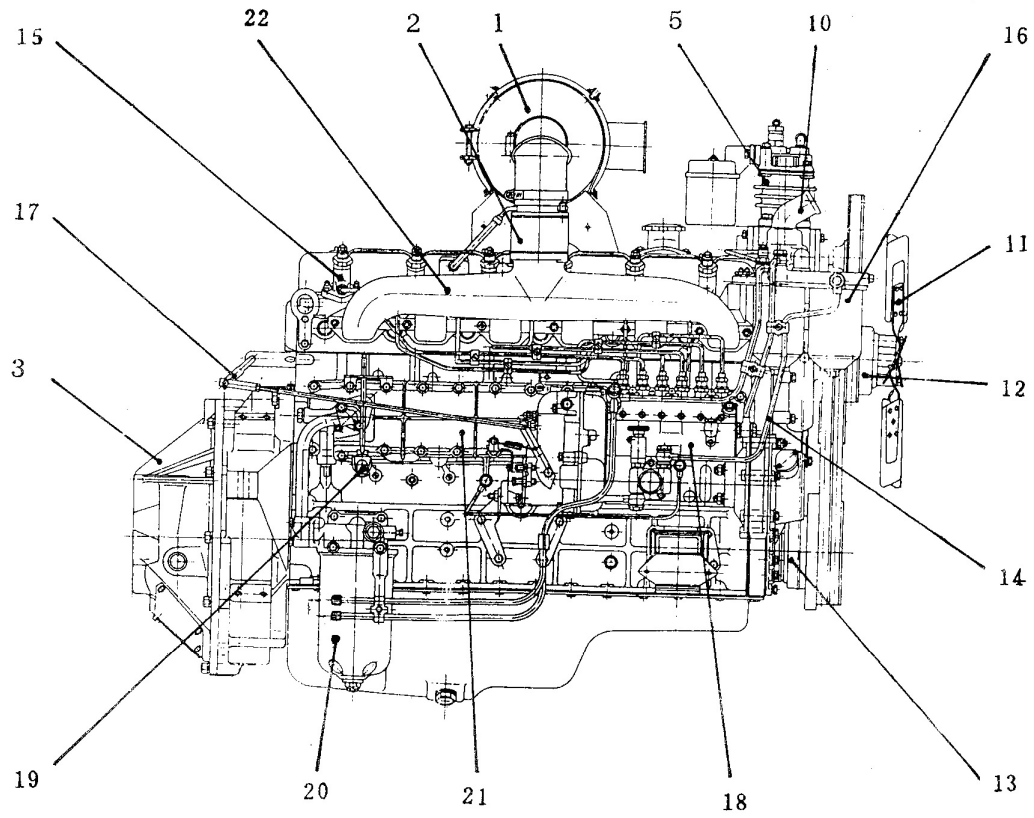

**Disassembly order:**

**1. Air filter**

**2. Inlet pipe**



**3. Clutch case and clutch**

**4. Starter**

**5. Brake air compressor**

**6. Generator**



**7. Breather**

**8. Dipstick**

**9. Push rod chamber cover**

**10. Thermostat**

**11. Fan**

**12. Water pump**

**13. Hydraulic steering pump**

**14. High-low pressure fuel pipe**

**15. Injector**

**16. Fuel filter**

**17. Throttle lever**

**18. Injection pump**

**19. Drain valve**

**20. Oil filter**

**21. Oil cooler**

**22. Inlet pipe**

**23. Exhaust pipe**

**24. Cylinder-head**



**25. Oil sump**



**\* It installed supercharger system on supercharger engine, and supercharger can be disassembled separately, and also can be disassembled with exhaust pipe. There is connection pipe between supercharger and inlet pipe. There is oil inlet & return pipe on the super-charger. See 6102BZQ diesel engine overview.**

**(1) Must disassemble in the right place.**



**(2) Before disassembly, must drain cooling water and oil.**

**(3) Disassembled bolt & nut order of bolt assembly must be counter-clock with assembly order. (See assembly notes.)**



**(4) Must block inlet and outlet port of every spare part for disassembly, in case dirt goes inside.**

## Outside parts assembly

To clean every spare part, especially  
pay attention to the cleaning of joint  
and hole for every part.



In principle, Assembled order must be counter-clock with  
disassembly order. (See above and overview drawing.)

In principle sealing gasket should be replaced (Except elasticity  
gasket).

The other notes:

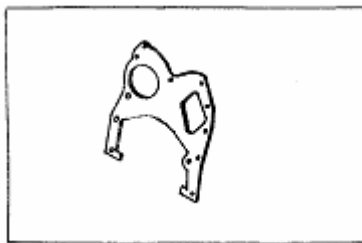

### 1) Seal gasket and plug

When installing, oil sump gasket,  
push-rod chamber gasket, gear chamber  
cover gasket, must be painted sealing  
glue.

Bolt and the other parts need to be  
painted sealing glue.

### 2) Water pump

Aside which the water pump gasket  
contacted engine smeared sealing glue.

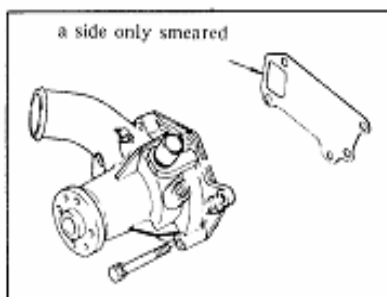

### 3) Inlet pipe

When assembly inlet pipe,

**tight screw bolt and nut**

**according to the stipulated digital order and required torque.**

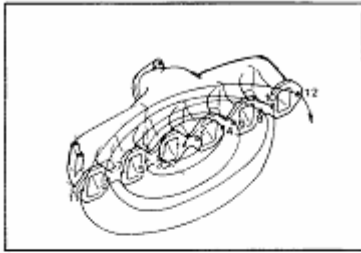

#### **4) Exhaust pipe**

**When assembly exhaust pipe, the two short bolts are on the exhaust pipe of six cylinders, the two long bolts are fixed breathing apparatus. Pay attention no t to install wrong and pay attention to sleeve pipe must put in concave.**

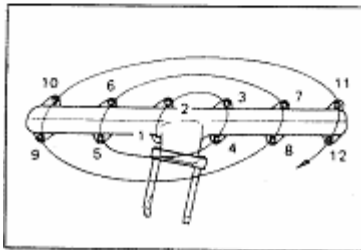
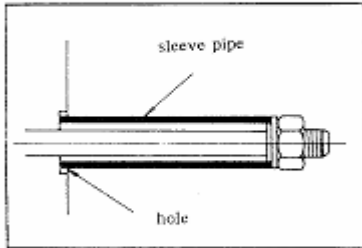

**To tight bolts according to the stipulated digital order and required torque.**

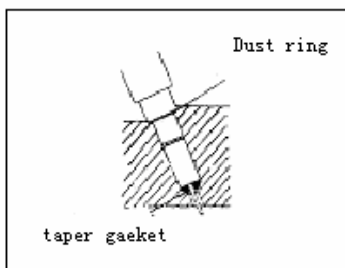

**5) Injector When assembly injector, check and replace dust cover and tape gasket.**

#### **6) Injection pump**

**To make pulley injection timing**

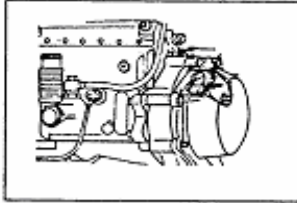

line justification with timing pointer, when installing injection pump, make the scale of supplying oil advancer justification with arrow of timing mark on observing hole, then use seven M8 bolts on gear chamber cover to tight.

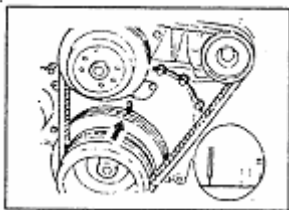

#### 7) High pressure oil pipe

To tight connection nut between draining oil valve seat and two ends of high pressure oil pipe without measure is not right.

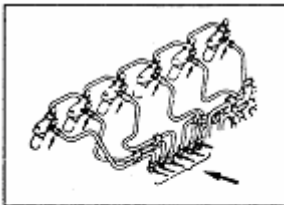

Tighten moment at two ends nuts is 25~35 (N.m).

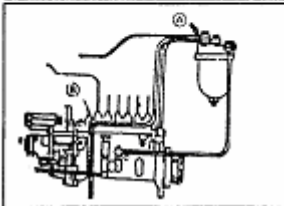

Tighten moment of draining oil valve seat is 40~45 (N.m).

When assembly fuel low pressure oil pipe, pay attention to the position of single valve.

Single valve: A B

#### 8) Oil cooler

**Tight screw bolt according to the stipulated digital order and required torque.**

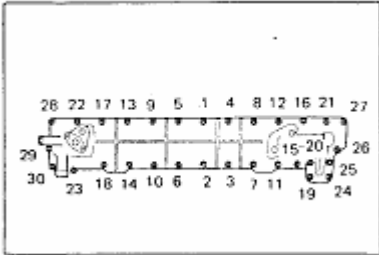

**Note: Different length screw bolts don't make wrong.**

### **9) Drain valve**

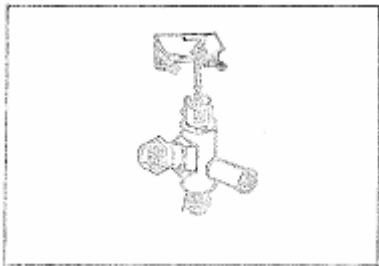

**Fix drain support plate with the bolts of oil cooler, make the two bolts lengthen, and don't make wrong.**

### **10) Oil sump**

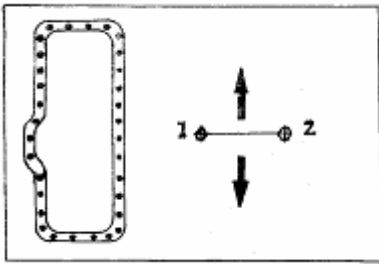

**Tight screw bolt according to the stipulated direction and required torque.**

### **11) Cylinder-head cover**

**Tight screw bolt according to the stipulated digital order and required torque.**

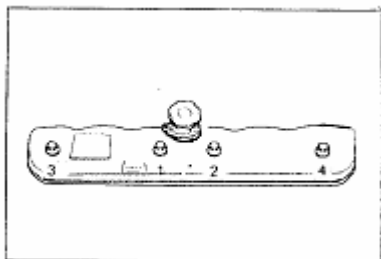

### **12) Fan (water pump) belt and air**



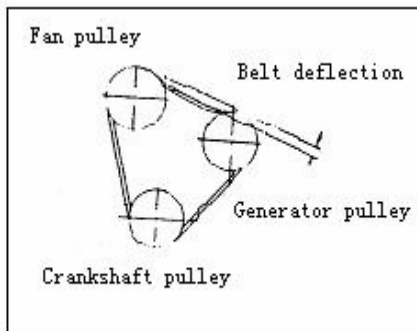

**compressor belt**

**Add belt (single belt) with 39 N strength, the deflection is 10~15mm.**

**13) Valve clearance adjusting**

**According to following methods**

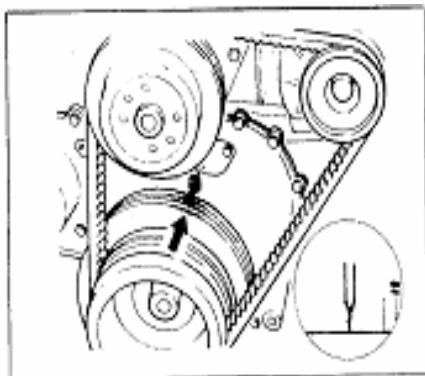

**adjust valve clearance with 6102.29.10 valve clearance plug guage.**



**Rotary crankshaft according to diesel engine rotation direction,**

**make the T.D.C scale on crankshaft damper**



**pulley justification with timing pointer or scale on gear chamber cover and in**



**order to make piston of the first and the sixth cylinder (the first and the fourth cylinder for 4102) locate T.D.C. . Rock the first inlet and exhaust valve rock-arms from up and down by hand. If there is clearance between them, it showed**

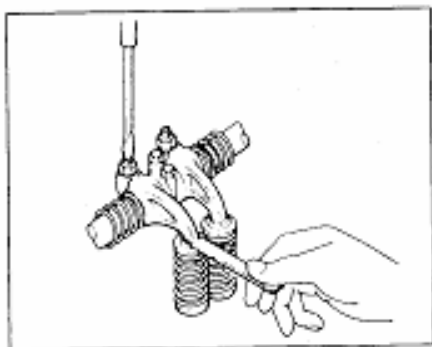

the first cylinder piston locates compress stroke T.D.C..

If there is not clearance between the two rock-arm, but there is clearance between rock-arm of inlet and exhaust valve on the sixth cylinder (the fourth cylinder for 4102), it showed the sixth cylinder piston locates compress stroke T.D.C..

To finish all valve clearance adjusting by two times.

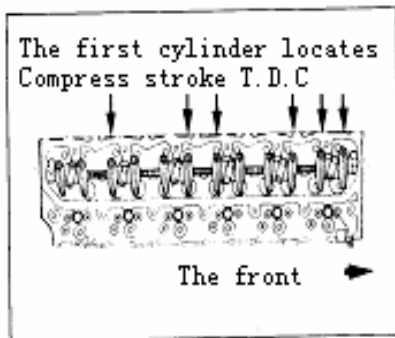

Cooling standard valve clearance:  
the front

|                              |
|------------------------------|
| Inlet and exhaust valve (mm) |
| 0.4                          |

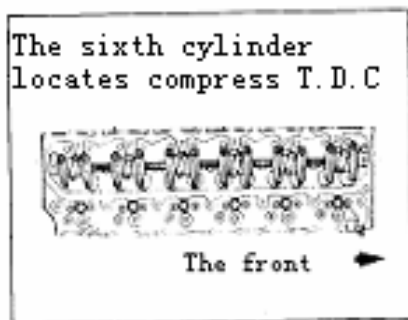

14) Static supply oil timing adjusting  
Loosen two ends nuts on the first cylinder high pressure oil pipe, and

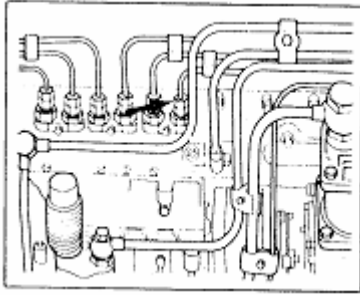

screw off nuts at injection pump draining oil valve end. Make oil pipe off the first cylinder draining oil valve, and connect view pipe, and make view pipe fill oil, or blow cleaning oil in draining oil valve cone with mouth.

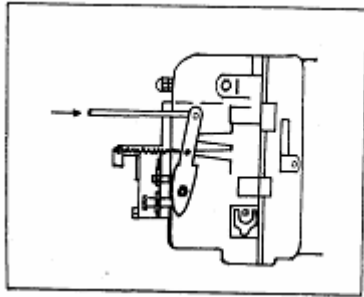

Making supply oil handle pull biggest oil volume direction.

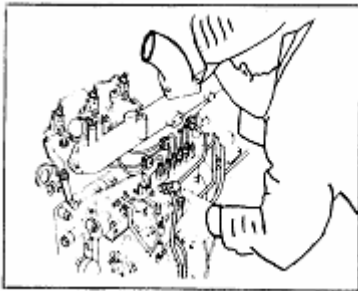

Running crankshaft in order to confirm the start point of supply, and slowly rotated near the first compress T.D.C, and view oil surface in pipe or drain oil valve. If oil surface move, it showed it began to supply oil.

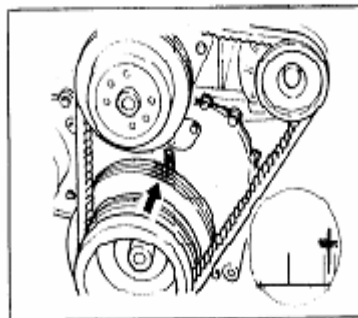

View scale of timing pointer on the crankshaft damper pulley.

If supply oil advancer is not right, loosen two nuts outside connection flange of injection pump, if advancer is very small, make injection pump rotate to outside of engine, whereas rotate to inside of engine, when view injection oil

timing again, till meet requirements, then  
revolve tightening connection nuts.

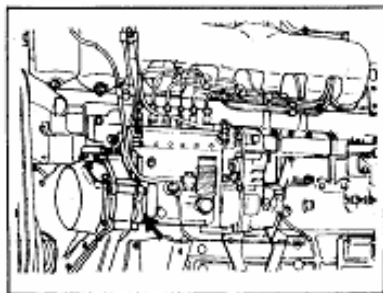

| Supplying oil timing | Applying engine type                                       |
|----------------------|--|
| 18° -20°             | 6102Q、 6102G、 6102G1、 6102G2、 6102B1Q                      |
| 19° -21°             | 6102、 6102SQ1、 6102BG、 6102BG1                             |
| 20° -22°             | 6102AQ   |
| 14° -16°             | 4102Q  |
| 16° -18°             | 4102BQ 、 4102BG 、 4105Q<br>6102BZ (with 2 degree advancer) |
| 18°                  | 6105Q  |
| 10° -12°             | 6102BZQ (with 4.8 degree advancer)                         |
| 7° ± 1°              | 4102EZLQ (with 4 degree advancer)                          |
| 5° ± 1°              | 4102BZLQ-A (with 4 degree advancer)                        |
| 8° ± 1°              | 6102BZLQ   |
| 14° ± 1°             | 4100ZLQ  |

### 15) Oil passage exhaust

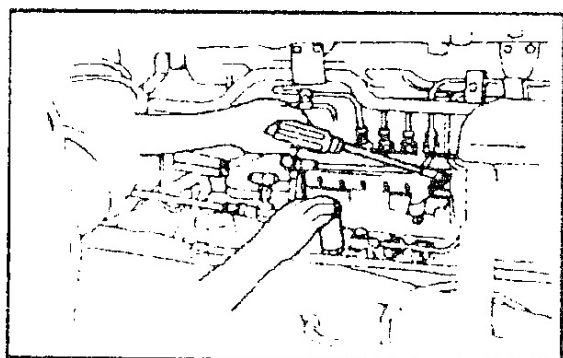

Making handling pump revolve out,  
and handle hand oil pump to supply  
oil to fuel system.

Loosen screw top screw of return oil  
pipe and exhausting screw of  
injection pump, and continue to

supply oil with hand oil pump, till oil full and flow, it can be stopped.

Then tighten screws.

## 16) VE pump static supplying timing adjusting

Supplying oil timing adjusting of VE pump is different from AD strengthening pump and P pump, VE pump confirmed supplying oil timing by plunger stroke. Adjusting of VE pump plunger stroke is following:

- (1) Cut off low pressure oil pipeline of injection pump.
- (2) Connect cooling starting accelerator (KSB) electrical source, and preheat to make KSB advance lever close with stop lever.
- (3) Screw off screw plug on distribution head among four drain oil valves, and install plunger stroke gauge of VE pump. The gauge is made of percent gauge with installing jointer,

please see the right drawing. The percent gauge may move in installing jointer, and it can be fixed by the fixed screw. After fixed plunger strokes gauge, and move crankshaft, and check if there is reading about percent gauge of VE

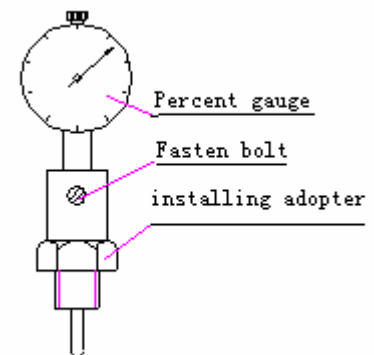

pump plunger stroke gauge. If there is no reading in range of a corner of crankshaft or all corners of crankshaft, it showed the contact head of percent gauge can not contact VE pump cam, then should loose fixed screw, and move percent gauge inside, and ensure in any crankshaft corners, the contact head of percent contact with VE pump cam, then tight percent gauge and fix screws.

**(4) After installed and adjusted VE pump plunger stroke gauge, moved crankshaft, and confirmed the lowest point of plunger stroke ( move the crankshaft in range of a corner of crankshaft, the pointer of percent gauge keep not to move and the number is min.). Then keep crankshaft not to move, and slightly turn dial of percent gauge, and make pointer of percent gauge justification with aero scale of dial. Then according to real the direction of engine move crankshaft to the first cylinder compress T.D.C, at the same time the reading on the plunger stroke gauge percent gauge is the stroke of plunger. If the plunger stroke don't meet requirement, and loose three nuts on connection flange on VE pump body, if want to increase plunger stroke, when ensure the first cylinder compress T.D.C, move injection pump body far away the direction of diesel engine . After moving pump body every time, it need to confirm again the lowest point of plunger stroke and adjust zero, and check the plunger stroke again when crankshaft locates the first cylinder compress T.D.C., till plunger stroke meet the value which operation manual stipulated, then tight VE pump body and fix nut.**

**Crankshaft locates the first cylinder compress T.D.C, the plunger strokes of every engine type is following:**

| Plunger stroke | Applying engine (installing VE pump) |
|----------------|--------------------------------------|
| 0.9 ~ 1.1      | 4102EZLQ                             |

# Inner parts disassembly and assembly

## Inner parts disassembly

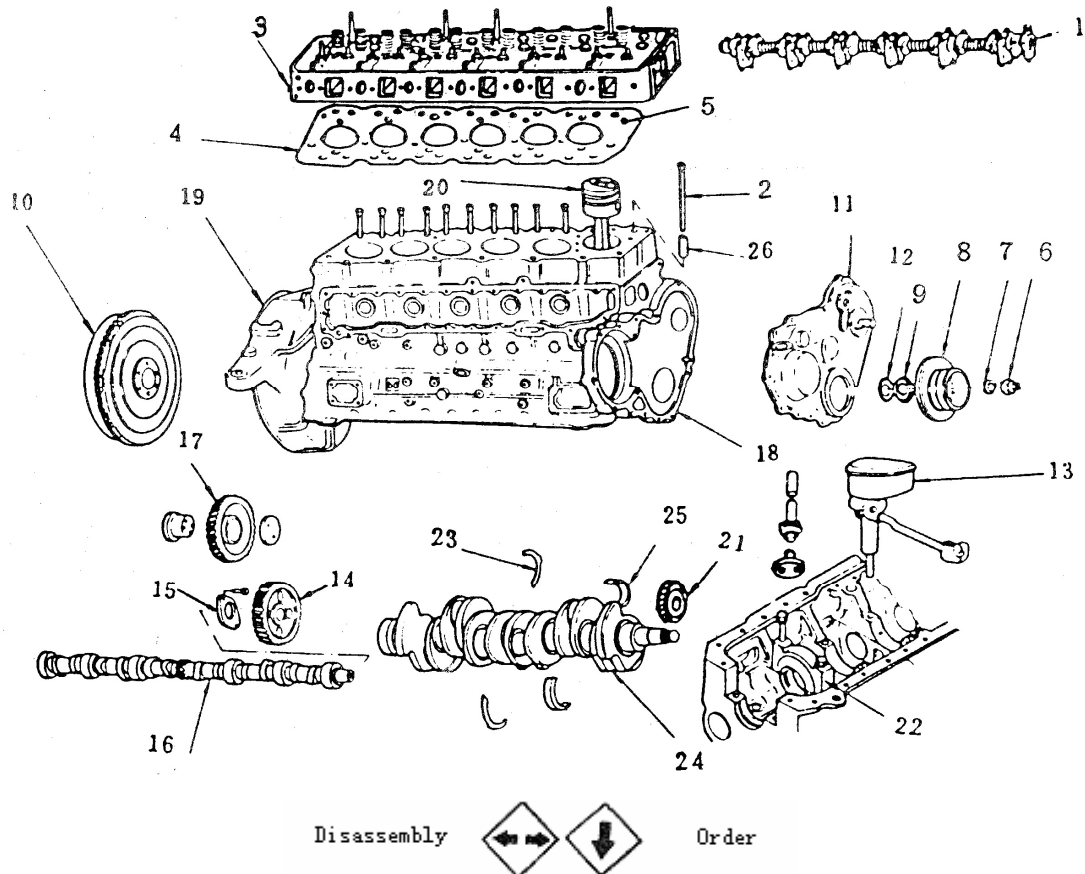

- |                           |  |
|---------------------------|--|
| 1. Rocker-arm shaft joint | 8. Damper joint                                      |
| 2. Push-rod joint         | 9. Oil baffle  |
| 3. Cylinder-head          | 10. Flywheel   |
| 4. Cylinder-head gasket   | 11. Gear chamber head                                |
| 5. O seal ring            | 12. Oil thrower disk                                 |
| 6. Start paw              | 13. Oil pump, gear shaft and spline housing assembly |
| 7. Gasket                 |  |

- |  |  |
|--|--|
| 14. Camshaft gear                        | 22. The main bearing cover   |
| 15. Camshaft thrust piece                | 23. Crankshaft thrust piece  |
| 16. Camshaft                             | (upper and lower)  |
| 17. Idler joint and idler shaft assembly | 24. Crankshaft   |
| 18. Gear chamber                         | 25. The main bearing shell   |
| 19. Flywheel case                        | 26. Plunger  |
| 20. Piston connect-rod joint assembly    |  |
| 21. Crankshaft gear                      |  |

1. Disassemble bolts and nuts order in bolts assembly is counter clock with assembly. (See assembly notes.)
2. The special tool in disassembly is same with assembly.
3. Must put separately the right place for spare parts of disassembly, and must make marks for group match.

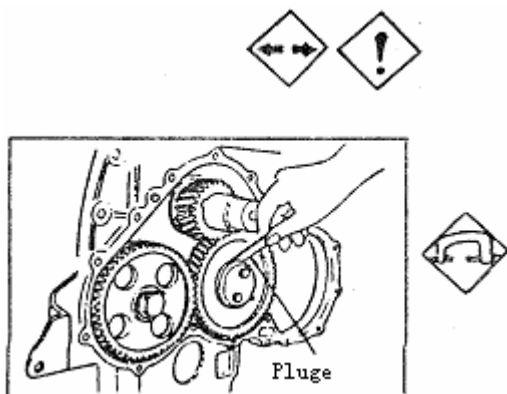

4. When disassembly, the measure value is following:

- 1) Idler and camshaft axial clearance. Idler



|                |             |
|----------------|-------------|
| Standard value | Limit value |
| 0.065-0.169    | 0.25        |

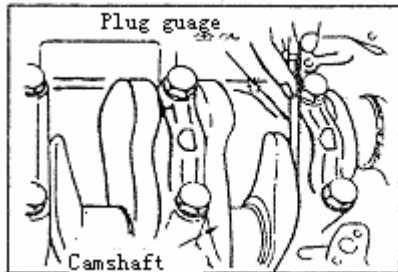

Camshaft

|                |             |
|----------------|-------------|
| Standard value | Limit value |
| 0.09-0.168     | 0.25        |

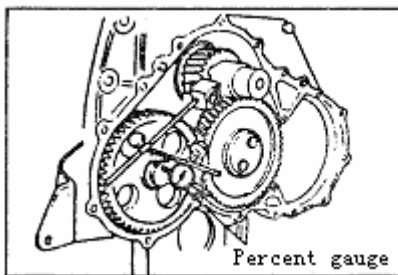

2) Crankshaft axial clearance

|                |             |
|----------------|-------------|
| Standard value | Limit value |
| 0.115-0.256    | 0.4         |

3) Timing gear backlash

| Engaging gear                 | Standard value | Limit value |
|-------------------------------|----------------|-------------|
| Crank shaft gear and idler    | 0.10-0.18      | 0.35        |
| Idler and camshaft gear       | 0.12-0.21      | 0.35        |
| Idler and injection pump gear | 0.12-0.21      | 0.35        |

### Inner parts assembly

- (1) Before installing, clean thoroughly every spare parts, especially the bush of the second producing, must pay attention to the cleaning of oil passage hole.
- (2) In principle the order of assembly is counter clock

with disassembly, that is, the first disassembly spare parts must be installed late, but the last disassembly spare parts must be installed first.

(3) When assembly, every moving joint surface add proper lubrication oil.

(4) Connect-rod shell, the back of the main bearing shell and shell-cover can't have oil, in case effect to diffuse heating.



(5) The other notes:

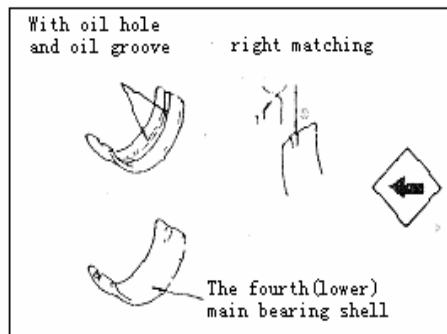

1) The main bearing shell  
Make position mouth of the main bearing shell install the position groove of the main bearing cover.

The fourth lower main bearing shell has no oil hole and complete thorough oil groove.

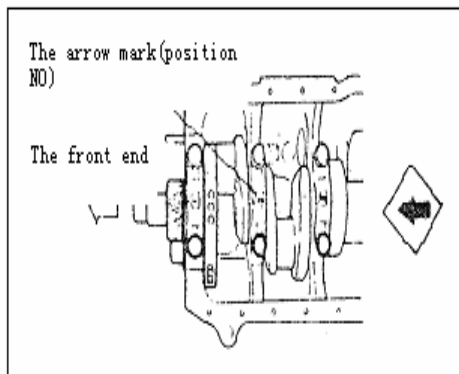

2) The main bearing cover The arrow of the main bearing cover points to the front of engine. The number in arrow is position no., that is the matching No. with engine.

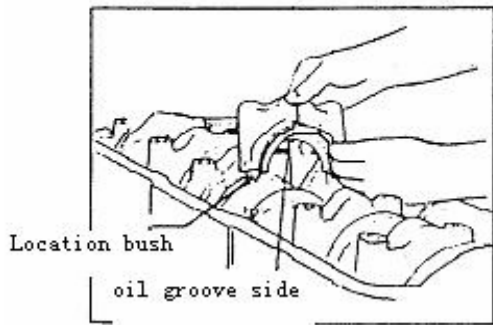

3) Crankshaft thrust piece

Oil groove of upper and lower thrust piece faced to the surface of crankshaft. The position protruding tail installed position groove of the main bearing head.

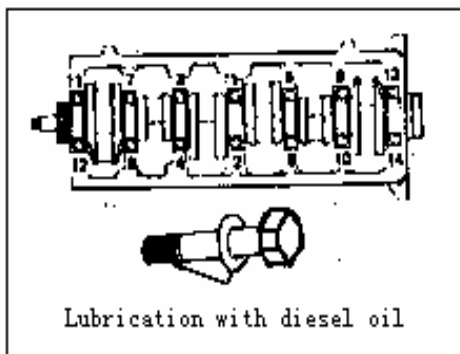

4) The main bearing bolts  
Tight the requiring torques by two times according to stipulation digital order.

|                     |                |
|---------------------|----------------|
| <b>Torque (N.m)</b> | <b>216-235</b> |
|---------------------|----------------|

5) Piston connect-rod joint

The opening of piston ring locates recommending position.

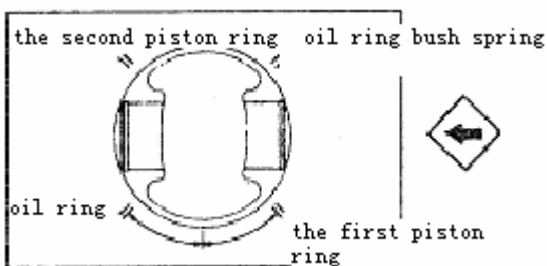

The mark on the piston top faced to the front (or the big concave of inlet valve leans to the front).

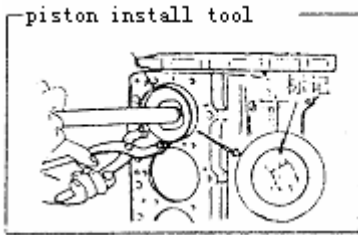

When installed piston, must use special tool to make ring compress.

The one side on bolt of connect-rod big end is matching No., and the other side is quality group No..

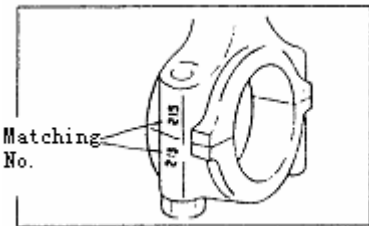

After connect-rod bolt must smear oil, then assembly them.

|                     |         |
|---------------------|---------|
| <b>Torque (N.m)</b> | 118-127 |
|---------------------|---------|

### 6) Idler shaft

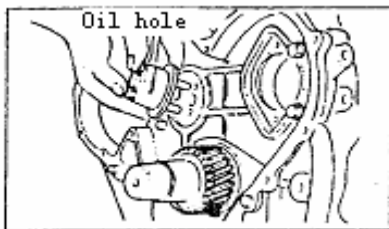

Oil hole faced to camshaft gear.

After installed gear and press plate, then make bolt tight.

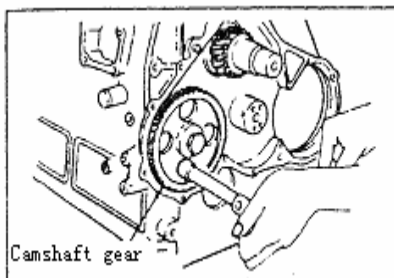

### 7) Camshaft thrust piece and gear

Make thrust piece bolts tight by the hole on the camshaft gear.

After smear oil, assemble camshaft gear and compress bolts.

|                     |         |
|---------------------|---------|
| <b>Torque (N.m)</b> | 118-118 |
|---------------------|---------|

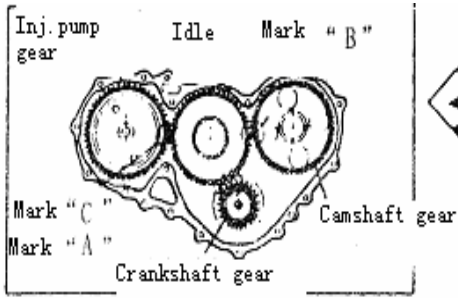

8) Timing mark

Install the timing gear according to timing mark symbols. Chamfer of idler press plate is outside.

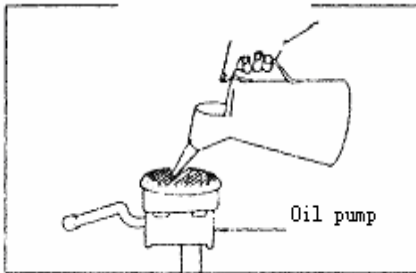

9) Oil pump

After filled oil, assemble it.

After installed gear shaft, must

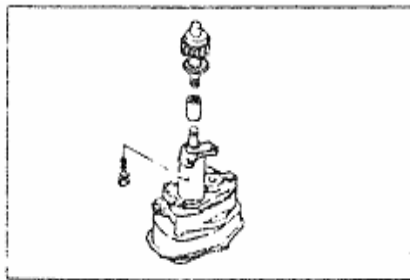

rotate camshaft, can't have block.

10) Flywheel case

Black part must smeared seal glue or liquid gasket. (Belco Bond 4 #)

After outside bolts were smeared oil, then assemble it.

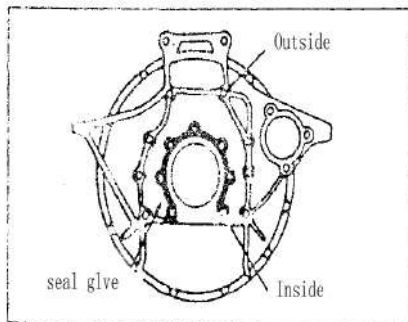

|                     |         |
|---------------------|---------|
| <b>Torque (N.m)</b> | 127-147 |
|---------------------|---------|

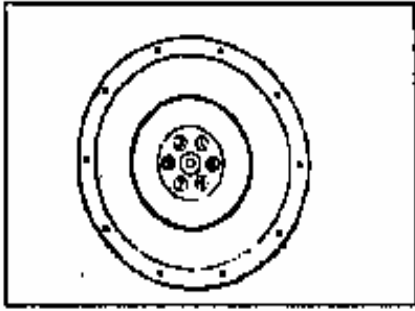

### 11) Flywheel

Smear oil to thread of the screw and the head end, then tight them according to digital order and requiring torque.

|                     |         |
|---------------------|---------|
| <b>Torque (N.m)</b> | 186-206 |
|---------------------|---------|

\*turbo-charge/inter-cooling engine is 196-216.

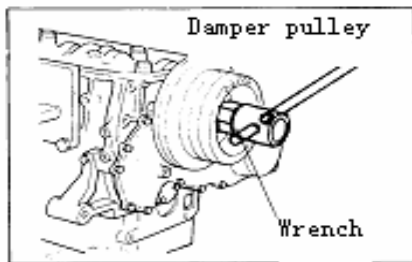

### 12) Start paw

Smear oil to thread of the screw, then tight start paw according to the requiring torque by 6102.29.01 and 6102.29.02 start wrench.

|                     |         |      |
|---------------------|---------|------|
| <b>Torque (N.m)</b> | 588-637 | 6102 |
| <b>Torque (N.m)</b> | 392-441 | 4102 |

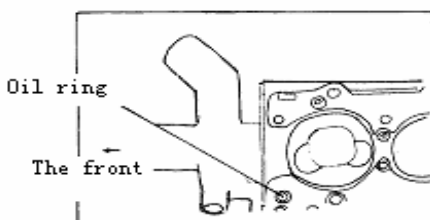

### 13) Cylinder-head gasket

Make cylinder hole dimpling-ram of cylinder gasket faced to the joint surface, and pay attention not to forget to install seal ring. (There is no 0

seal ring for 4102 engine.)

14) Cylinder-head

There are two kinds of length for the bolts of cylinder-head, the short should be installed injection pump side.

Smear oil to the thread and the head end, then tight according to the digital order and torque on drawing.

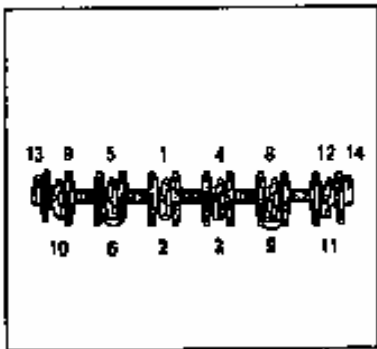
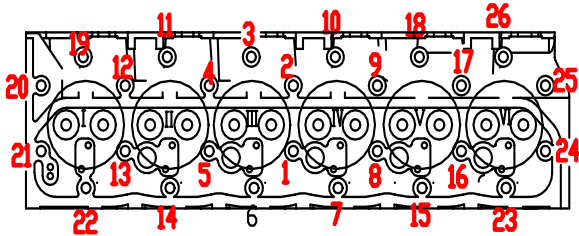

|                     | The 1st step | The 2nd step |
|---------------------|--------------|--------------|
| <b>Torque (N.m)</b> | 59           | 108-118      |

\* Turbo-charge engine is 118-127.

15) Rocker-arm shaft joint

Tight screw and nut according to stipulate digital order.

16) Valve clearance

Adjust valve clearance with 6102.29.10 valve clearance gauge.

See the previous section.

Cooling valve clearance

|                              |     |
|------------------------------|-----|
| Inlet and exhaust valve (mm) | 0.4 |
|------------------------------|-----|

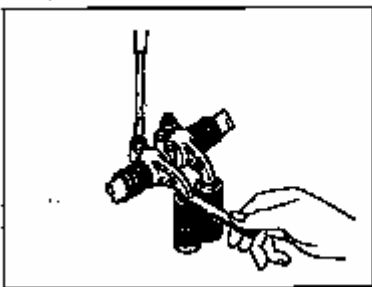

## Basic parts disassembly

### Basic parts disassembly

#### 1) Rocker-arm shaft joint

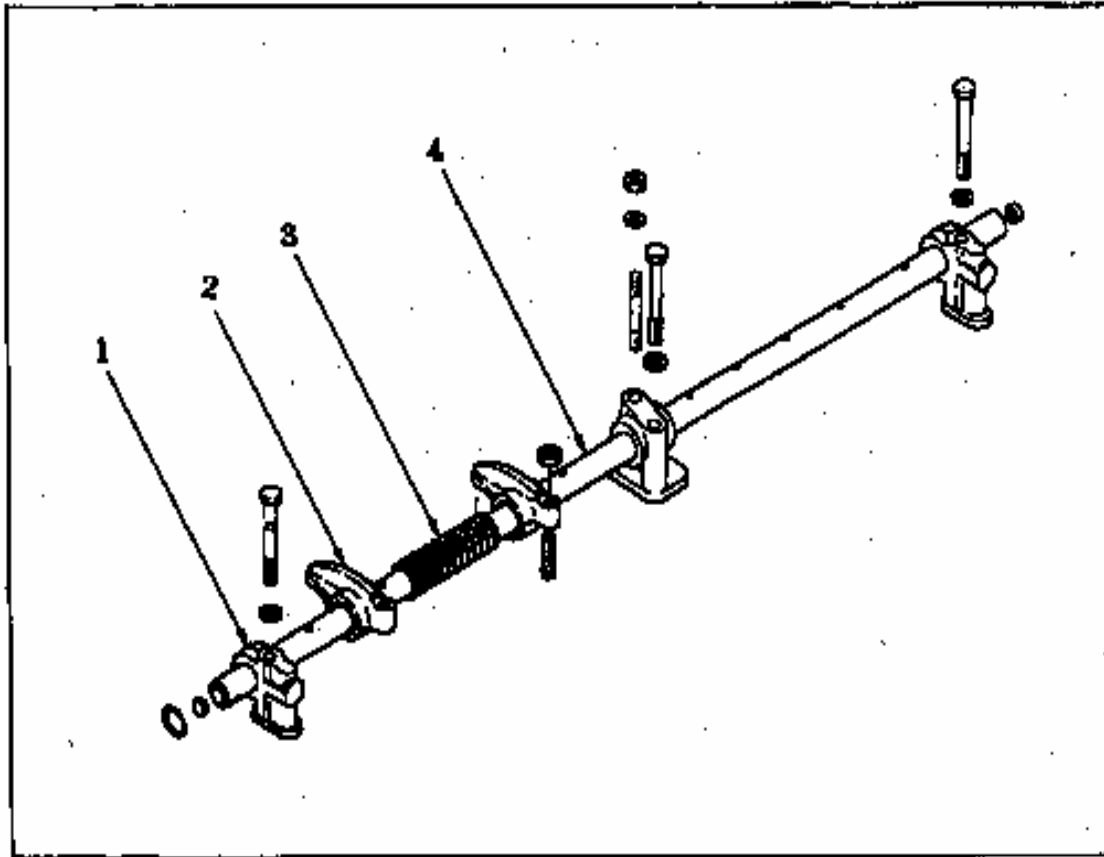

1. Rocker-arm seat (the total 8 piece for the front, middle and back three kinds.)
2. Rocker-arm joint
3. Spring
4. Rocker-arm shaft(three kinds)and connect shaft.



## 2) Cylinder-head and valve assembly

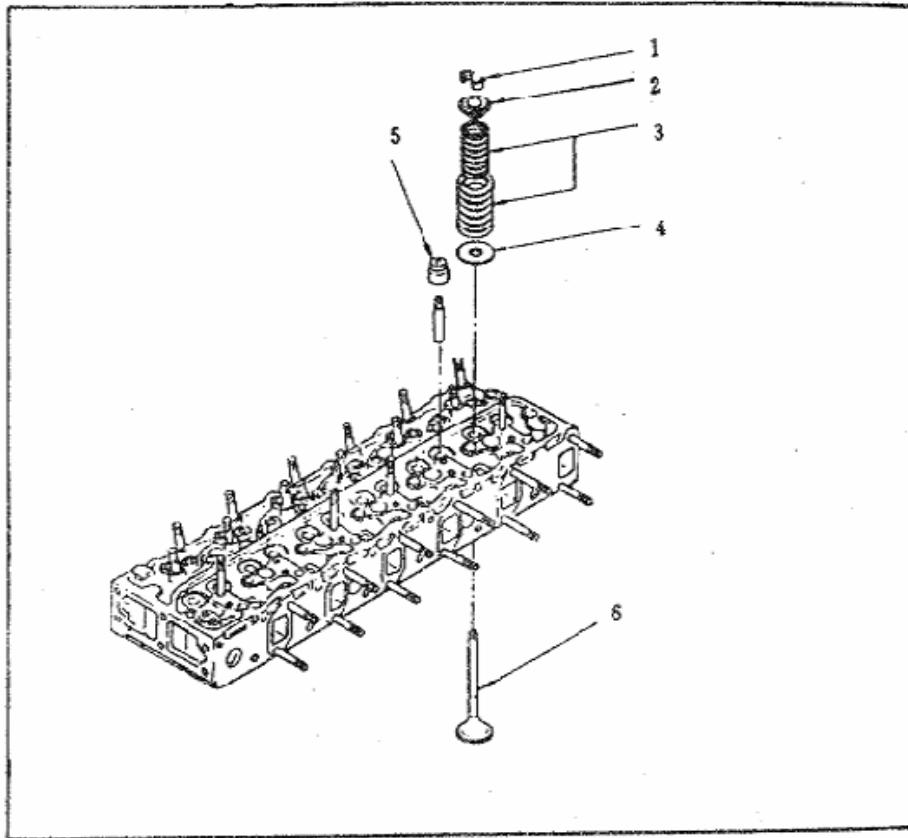

1. Valve split

4. Valve spring gasket

2. Valve spring seat

5. Valve seal bush joint

3. Valve inside and  
outside spring

6. Inlet and exhaust valve

Use the special tool for disassembly valve split and valve seal bush.

### 3) Piston connect-rod joint assembly

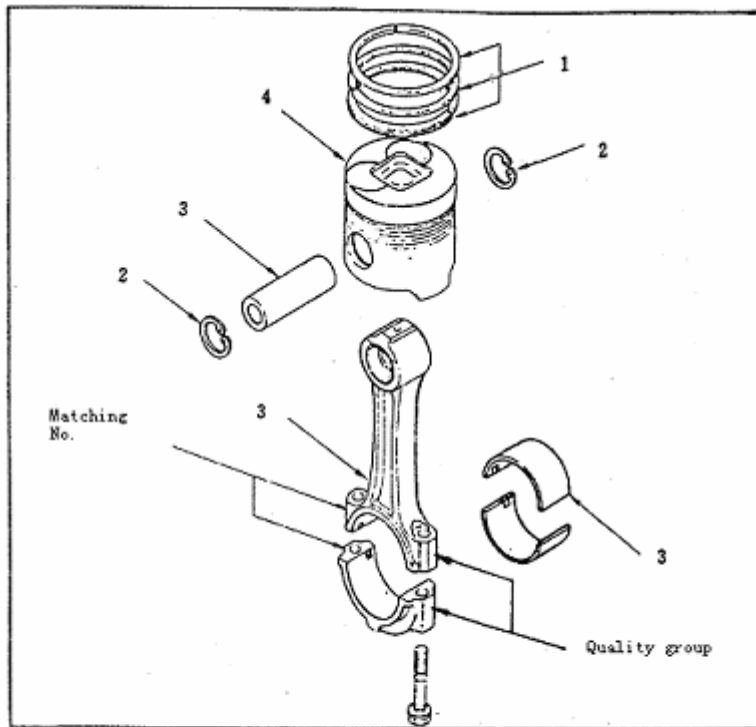

1. Piston ring
2. Check ring
3. Piston pin and connect-rod (and shell)
4. Piston



Use the special tool for disassembly check ring and piston ring.

## 2 The basic parts assembly

In principle, the order of assembly is counter clock with the order disassembly.

Before assembly, should clean every spare parts, and especially pay attention to the cleaning of production surface and oil hole.



1)Rocker-arm shaft joint (See disassembly drawing.)

① Don' t make the front, middle and back rocker-arm shaft and every rocker-arm seat wrong.

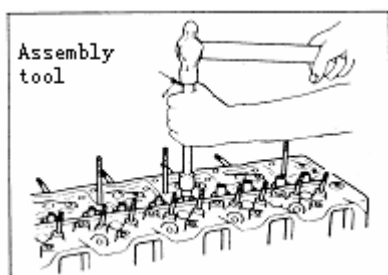

② Pay attention to the bolts with groove is on the front rocker-arm seat.

③ Oil hole of rocker-arm shaft faced up.

2) Valve assembly

① Valve seal bush joint

After seal bush is lubricated with cleaning oil, then install it. When install it, must use installing tool.

② Inlet, exhaust valve

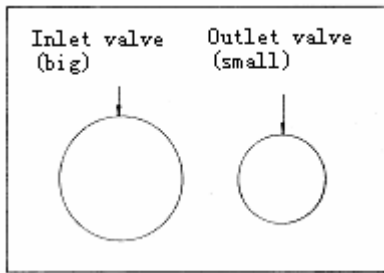

Because the head of inlet & exhaust



valve is different, don't make wrong.

③ Valve collets and valve spring seat

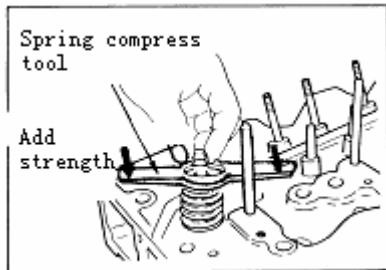

Disassembly and assembly valve collets and valve spring seat with 6102. 29. 03 disassembly valve tool.

④ After assembly valve collets,

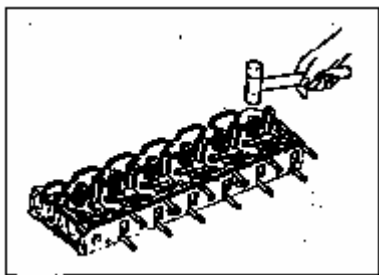

knock slight valve stem end with plastic hammer.

3) Piston connect-rod joint assembly

① Connect-rod

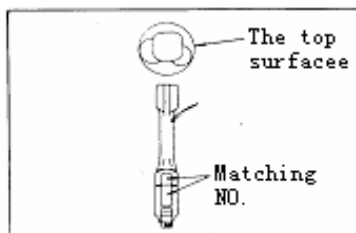

When assemble, the matching No. of connecting body and cover is the same side.

Pay attention to the position of

locating lip of connect rod shell and the direction of piston top.

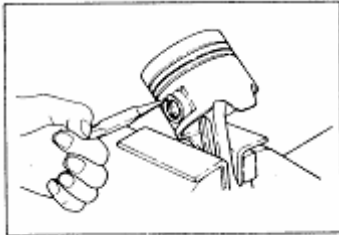

② Check ring

Disassembly and assembly check ring with special tool or check ring pliers.

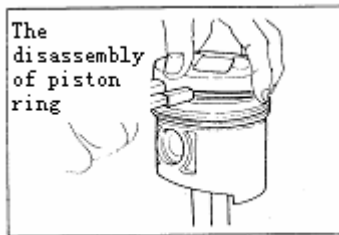

③ Piston ring

Use special tool disassembly and assembly piston.

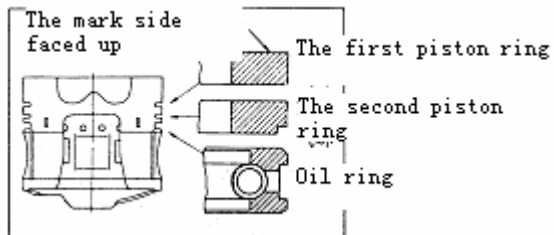

Every ring can't make wrong, the first ring with mark faced up, and the second ring groove faced down.

# Disassembly of interference assorting parts

## 1 Disassembly of interference assorting parts

When replace them, interference assorting parts can be disassembled.

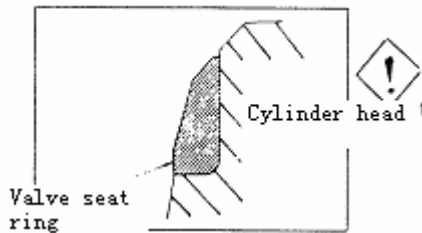

1) Disassembly of valve seat ring  
When valve sink exceed limit, must replace seat ring.

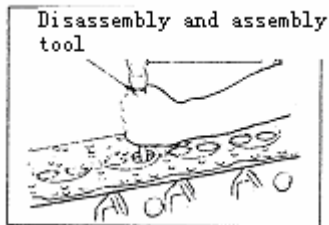

When disassembly valve seat ring, don't heat it, or make bottom holes deformation.

When replace it, don't increase hole to machine.

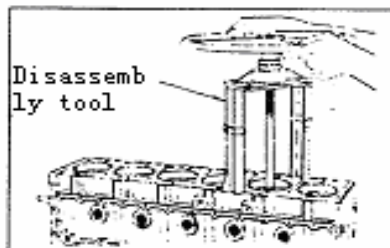

2) Disassembly of valve pipe

Disassembly valve pipe with blanking tool and hand hammer.

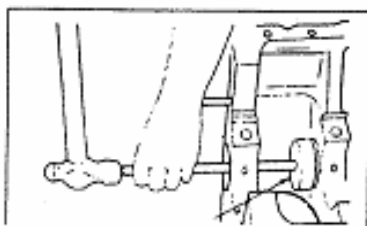

3) Disassembly cylinder sleeve

Draw with disassembly tool or extrude with matrix.

4) Disassembly of camshaft bush

Use special blank tool and hand hammer.

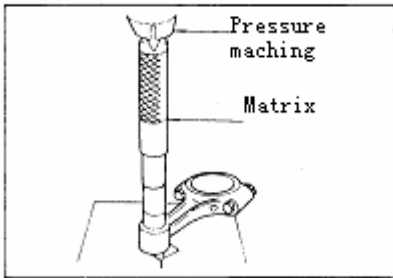

5) Disassembly of connect rod small end bush

Extrude small end bush with technology bar and pressure machine.

6) Disassembly of crankshaft gear

Disassemble crankshaft gear with disassembly tool.

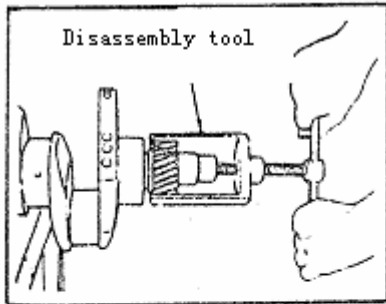

7) Disassembly of gear ring

Disassemble it with brass bar and hammer.

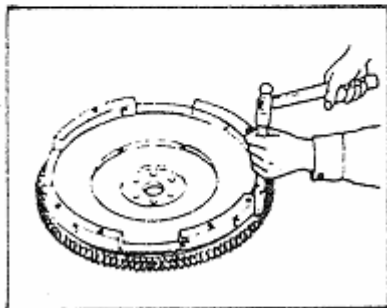

8) Disassembly of idle gear bush

Use special blank tool and hand hammer.

9) Disassembly of the front and back oil seal of crankshaft

Prize them with screw opener, and pay attention not to damage installing holes surface.

## 2 Assembly of interference assorting parts

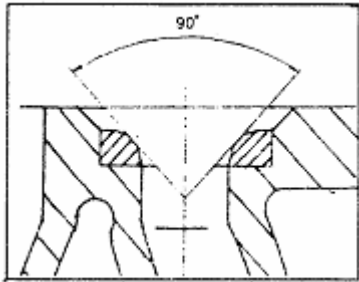

### 1) Assembly of piston seat ring

Clean completely metal oxide and accumulation carbon of valve seat ring hole surface on cylinder-head.

And compress it by pressure.

Ream valve seat with 90 degrees reamer, the contacting width is 1.0-2.0 mm with valve head seat surface.

### 2) Check of air distribution valve and seal performance

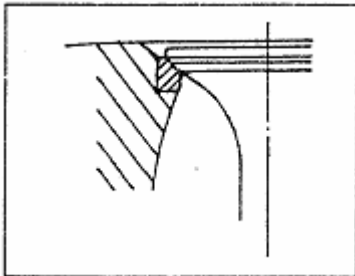

When use new valve and new valve seat ring, valve sink must be in the standard value.

Rub-up the surface of valve and valve seat ring, and smear red lead on the valve cane surface, and place valve on the seat, and slight rotate valve, the contacting ring belt should not to interrupt, the



width 1-2 mm.

Assembly valve spring, fill kerosene into inlet and exhaust passage, and lasting two minutes, and should not leakage.

If there are still some questions, should ream valve seat again and grind valve and seat ring with abrasive cream.

### 3) Assembly of valve pipe

Assemble valve pipe into cylinder head pipe hole by the blank tool and hand hammer.

The distance from supporting face of valve spring gasket on the cylinder head to top surface of valve pipe is 14.5mm.

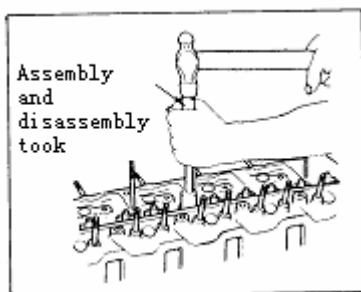

### 4) Disassembly of cylinder sleeve

Compress cylinder sleeve with positioner and pressure machine,

don't use hand hammer to install directly it.

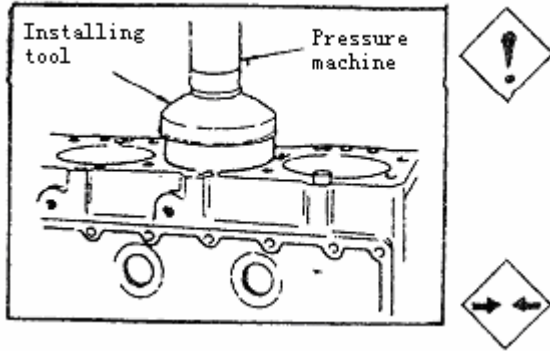

The compress strength of cylinder sleeve is 7840N, at last compress it (cast iron cylinder sleeve) with 27400N.

Note: Use the finished cylinder sleeve, must assembly by the group measure, or after maintenance, reduce greatly the reliability of diesel engine.

|                       |           |
|-----------------------|-----------|
| Standard interference | 0.01-0.03 |
|-----------------------|-----------|

Note: After use the semi-finished cylinder sleeve to compress, at last machine them according to the following measure machine them and group.

|   |                                 |
|---|---------------------------------|
| A | $\Phi 102.020 - \Phi 102.030$   |
| B | $> \Phi 102.030 - \Phi 102.040$ |
| C | $> \Phi 102.040 - \Phi 102.050$ |
| D | $> \Phi 102.050 - \Phi 102.060$ |

### 5) Assembly of camshaft bush

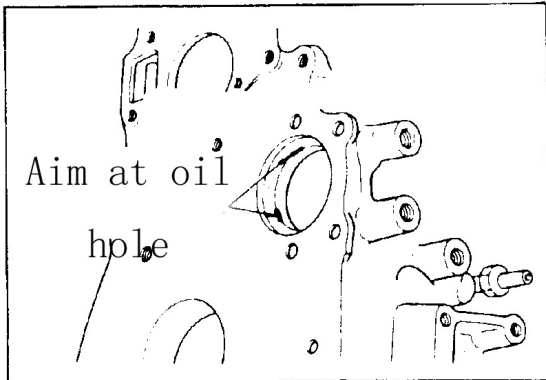

Install them with special blank tool and hand hammer.



When install bush, must make oil hole on the bush aim at oil hole of cylinder-block. Thereinto there are two holes in the front of bushes, only one oil hole on the other bushes.

Note: After compress semi-finished bush, it needs to be produced again, at the same time ensure the centre distance to be  $132.835 \pm 0.0315$  between the hole with idler shaft hole.

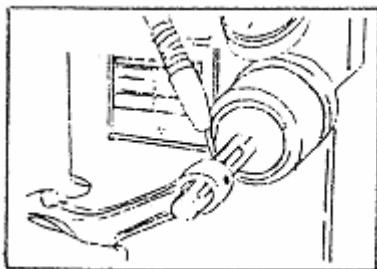

### 6) Assembly of connect-rod small end bush

Make bush compress with technology bar, pressure machine or hand hammer, pay attention to make oil hole adjustment. (See the

drawing).

After make bush enclose, and reaming with reamer. The centre distance between big and small end hole is  $192 \pm 0.03$  (6102, 4102BQ, 4102BG).

|                        |                             |
|------------------------|-----------------------------|
| Standard hole diameter | $\Phi 35.015 - \Phi 35.030$ |
|------------------------|-----------------------------|

Then measure the parallelism degree with the big head hole.

#### 7) Installing of crankshaft gear

Install it with installing blank tool and hand hammer.

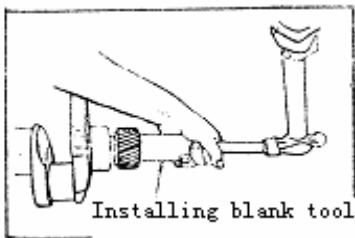

#### 8) Installing of gear

Make gear ring heat with gas blance or heating oil and make it expand, then install it with hammer.

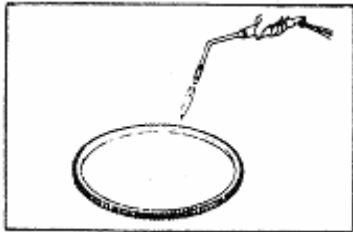

When install 6102A.03.11 gear ring of single piece clutch, pay attention to one side with double chamfer inside track faced to flying wheel.

#### 9) Assembly of idler shaft bush

Install it with installing

blank tool and hand hammer.

10) Replace of the front and back oil seal of crankshaft

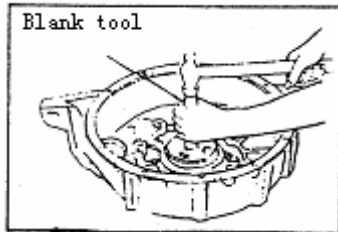

① Back oil seal installs on the flywheel case or back oil seal seats.

Install it with installing blank tool and hand hammer.

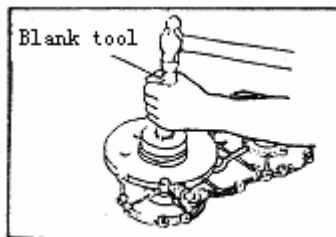

② The front oil seal installs gear chamber cover

Install it with installing blank tool and hand hammer.

## Check the basic parts

When check, if find wear, damage or the other abnormal phenomenon, repair and replace spare parts according to practice and requirements.

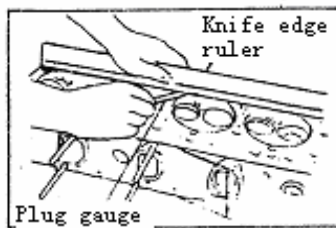

1) Bottom planeness and thickness of cylinder-head

|           | Standard | Limit |
|-----------|----------|-------|
| Planeness | 0-0.05   | 0.2   |
| Thickness | 90       | 89.7  |

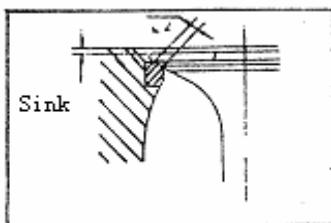

2) Inlet, exhaust valve sink

| Standard | Limit |
|----------|-------|
| 0.8-1.1  | 2.5   |

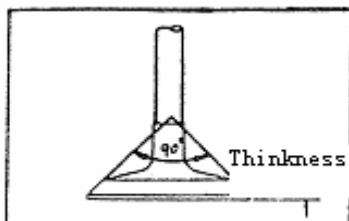

3) Valve and valve pipe

① Cone angle and the head thickness of valve seal:

Cone angle of valve seal: 90°.

The head thickness of valve

| Standard | Limit |
|----------|-------|
| 1.5      | 1.0   |

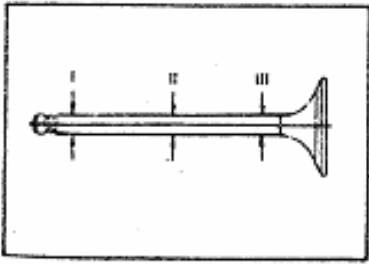

② Valve stem diameter

| Item          | Standard                  | Limit       |
|---------------|---------------------------|-------------|
| Inlet valve   | $\Phi 8.953 - \Phi 8.975$ | $\Phi 8.88$ |
| Exhaust valve | $\Phi 8.938 - \Phi 8.960$ | $\Phi 8.85$ |

③ Inside diameter of valve pipe

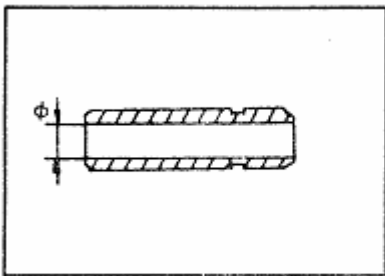

|                    | Standard                  | Limit       |
|--------------------|---------------------------|-------------|
| Inlet valve pipe   | $\Phi 9.000 - \Phi 9.022$ | $\Phi 9.08$ |
| Exhaust valve pipe | $\Phi 9.000 - \Phi 9.022$ | $\Phi 9.10$ |

④ The clearance between valve stem and pipe

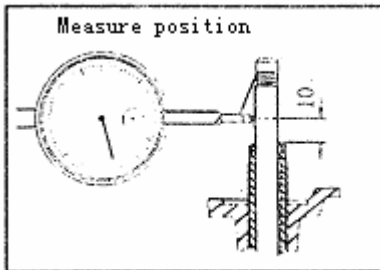

|                    | Standard    | Limit |
|--------------------|-------------|-------|
| Inlet valve pipe   | 0.025-0.069 | 0.20  |
| Exhaust valve pipe | 0.040-0.084 | 0.25  |

4) Valve spring

① Length and verticality of spring

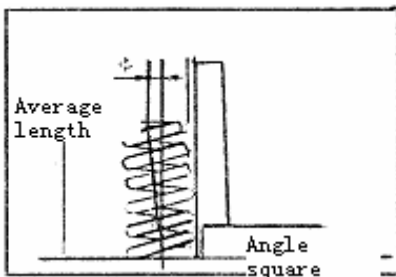

| Engine type | Item           |         | Standard | Limit | Verticality |
|-------------|----------------|---------|----------|-------|-------------|
| 6102        | Average length | Outside | 50.7     | 48.5  | $\Phi 1.8$  |
|             |                | Inside  | 45.5     | 44    | $\Phi 1.5$  |
| 4102        | Average length | Outside | 54       | 52    | $\Phi 1.5$  |
|             |                | Inside  | 52.8     | 51.5  | $\Phi 1.5$  |

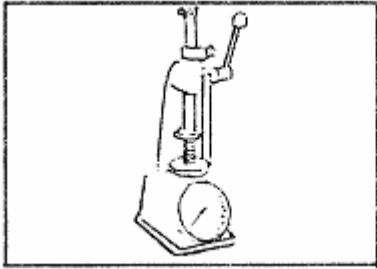

## ② Spring strength

| Engine type | The height after compress (mm) |      | Standard (N) | Limit (N) |
|-------------|--------------------------------|------|--------------|-----------|
| 6102        | Outside                        | 44   | 140          | 130       |
|             | Inside                         | 41.5 | 50           | 40        |
| 4102        | Outside                        | 43   | 252          | 242       |
|             | Inside                         | 40.5 | 114          | 104       |

## 5) Tappet

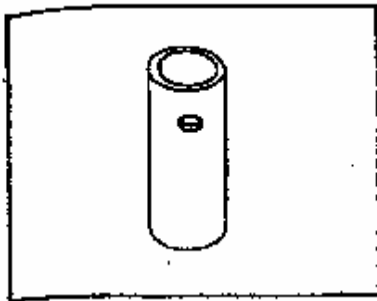

① If check tappet exists all kinds of wear, damage and the abnormal phenomenon.

② Tappet diameter

| Standard                    | Limit        |
|-----------------------------|--------------|
| $\Phi 27.939 - \Phi 27.960$ | $\Phi 27.92$ |

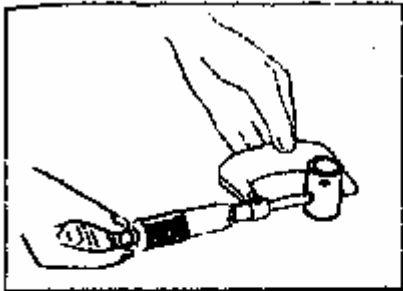

③ Inside diameter of tappet hole

| Standard                    | Limit        |
|-----------------------------|--------------|
| $\Phi 28.000 - \Phi 28.021$ | $\Phi 28.07$ |

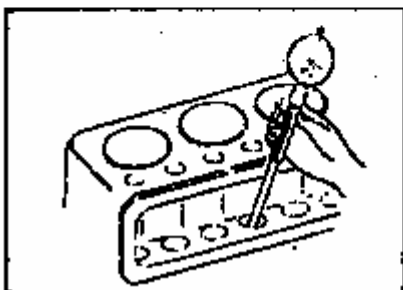

④ Clearance between tappet and tappet hole

| Standard   | Limit |
|------------|-------|
| 0.04-0.082 | 0.15  |



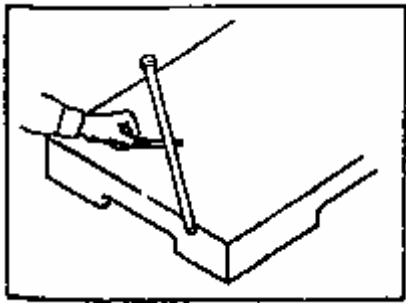

Straightness of push lever joint

Straightness of bus line

|       |     |
|-------|-----|
| Limit | 0.5 |
|-------|-----|

7) Rocker-arm shaft joint

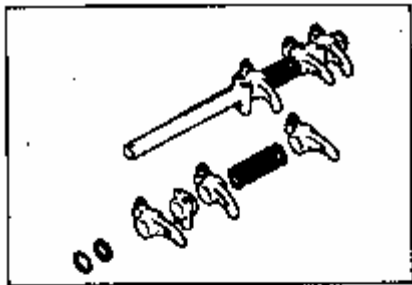

① Check all disassembly spare parts, and see if there are wear, damage and the other abnormal phenomenon.

② Rocker-arm shaft diameter

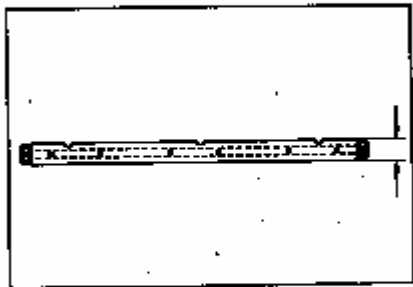

| Standard                    | Limit        |
|-----------------------------|--------------|
| $\Phi 19.980 - \Phi 20.000$ | $\Phi 19.86$ |

③ Inside diameter of rocker-arm shaft joint

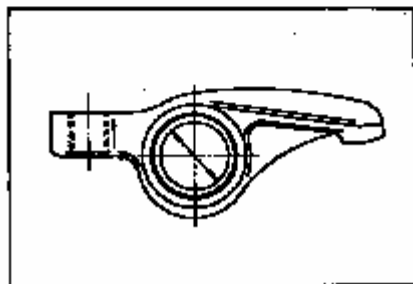

| Standard                    | Limit        |
|-----------------------------|--------------|
| $\Phi 20.020 - \Phi 20.041$ | $\Phi 20.06$ |

④ The clearance between rocker-arm and rocker-arm shaft

| Standard   | Limit |
|------------|-------|
| 0.02-0.061 | 0.20  |



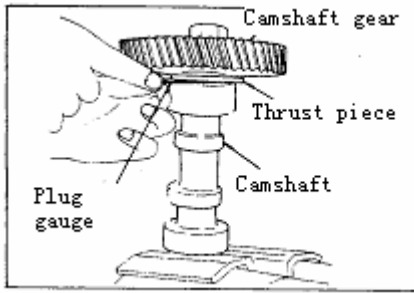

Every parts of camshaft

- ① Check all disassembly spare parts, and see if there are wear, damage and the other abnormal phenomenon.
- ② Axial clearance of camshaft

| Standard    | Limit |
|-------------|-------|
| 0.09-0.0168 | 0.25  |

- ③ Gear side clearance of camshaft

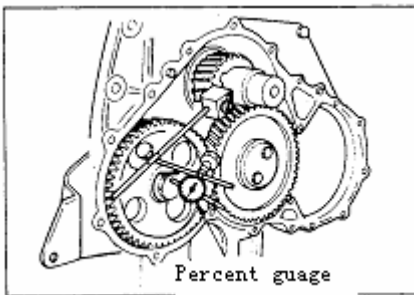

| Standard  | Limit |
|-----------|-------|
| 0.12-0.21 | 0.35  |

If there is abnormal phenomenon or side clearance is too big, should replace gear.

- ④ Shaft diameter of camshaft

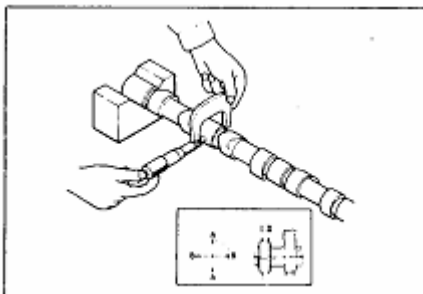

| Engine type    | Standard                    | Limit       |
|----------------|-----------------------------|-------------|
| Four cylinders | $\Phi 55.940 - \Phi 55.970$ | $\Phi 55.6$ |
| Six cylinders  | $\Phi 55.910 - \Phi 55.940$ | $\Phi 55.6$ |

- ⑤ Inside diameter of camshaft bearing

| Standard | $\Phi 56.00 - \Phi 56.030$ |
|----------|----------------------------|
|          |                            |

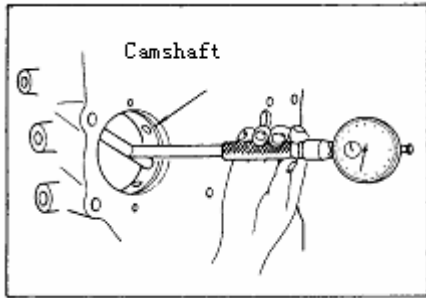

⑤ The clearance between camshaft and bush

| Engine type    | Standard  | Limit |
|----------------|-----------|-------|
| Four cylinders | 0.03-0.09 | 0.15  |
| Six cylinders  | 0.06-0.12 | 0.15  |

Note: When the axial diameter of camshaft is near limit value, if want to ensure matching clearance don't exceed limit value, should adjust the dimension of bush hole, or replace camshaft early.

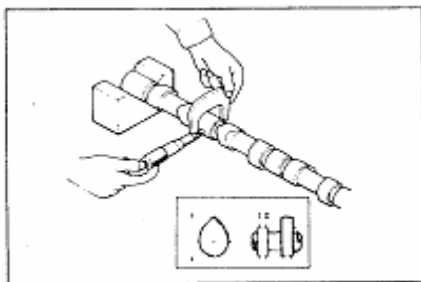

⑦ The height of camshaft

|         | Standard      | Limit |
|---------|---------------|-------|
| Inlet   | 47.612-47.712 | 46.5  |
| Exhaust | 47.636-47.736 | 46.5  |

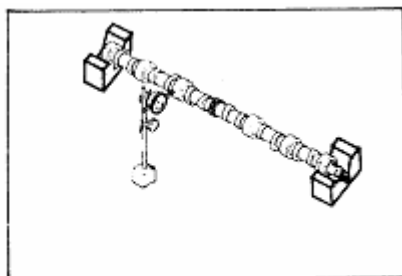

⑧ Radial beat of camshaft journal

|       |      |
|-------|------|
| Limit | 0.12 |
|-------|------|

9) Idler and idler axial

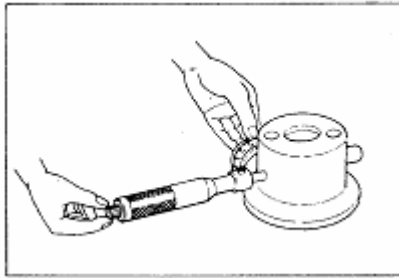

① Outside diameter of idler axial

| Standard                    | Limit         |
|-----------------------------|---------------|
| $\Phi 44.950 - \Phi 44.975$ | $\Phi 44.845$ |

② Inside diameter of idler

| Standard | $\Phi 45.000 - \Phi 45.025$ |
|----------|-----------------------------|
|          |                             |

③ Axial clearance between idler and idler axial

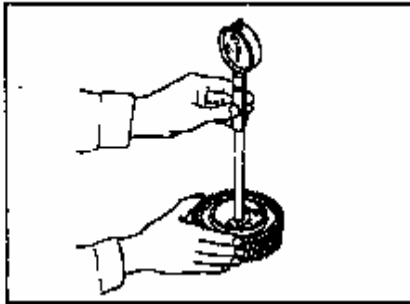

| Standard    | Limit |
|-------------|-------|
| 0.025-0.075 | 0.2   |

Note: When the idler axial diameter is near limit value, if want to ensure matching clearance don't exceed limit value, should adjust the bush dimension, or replace idler shaft early.

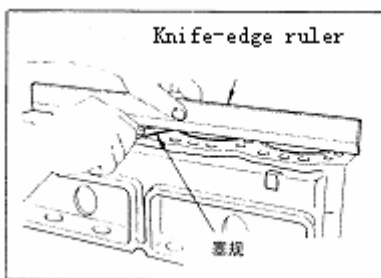

10) Planeness of the top surface of cylinder-block

| Standard | Limit |
|----------|-------|
| 0.05     | 0.2   |

11) Cylinder bush

① Inside hole of cylinder bush

The distance is about 15mm from measure position to up and down end.

| Standard                      | Limit    |
|-------------------------------|----------|
| $\Phi 102.020 - \Phi 102.060$ | 0.102.20 |

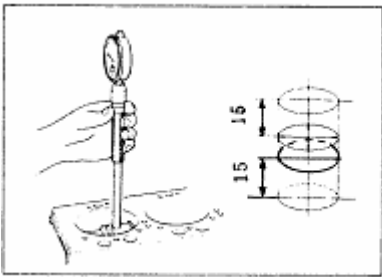

Note: Divided into four groups to match with piston.

② Protrude height of cylinder sleeve

|                 |           |
|-----------------|-----------|
| Protrude height | 0.05-0.12 |
|-----------------|-----------|

The height difference of neighbouring cylinder-holes is not more than 0.05.

12) Every parts of piston, piston pin and piston ring

① Dimension of piston skirt

Measure position perpendicular to axial line direction of piston pin and:

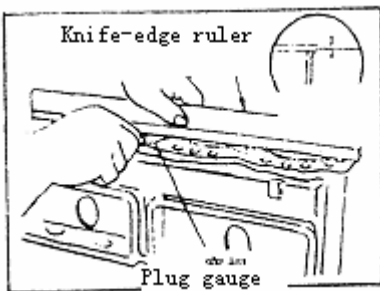

| Diesel engine stroke (S) | The distance from measure point to top (L) |
|--------------------------|--|
| 100                      | 80.5                                       |
| 110                      | 57   |
| 118                      | 53   |

Divided into groups for dimension (for example 102 series).

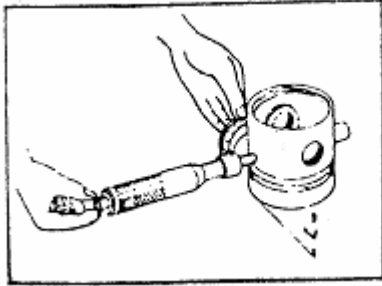

|        |                 |                                |                               |
|--------|-----------------|--------------------------------|-------------------------------|
| engine | Non turbocharge | A                              | $\Phi 101.830 - \Phi 101.840$ |
|        | B               | $>\Phi 101.840 - \Phi 101.850$ |                               |
|        | C               | $>\Phi 101.850 - \Phi 101.860$ |                               |
|        | D               | $>\Phi 101.860 - \Phi 101.870$ |                               |

|        |             |                                |                               |
|--------|-------------|--------------------------------|-------------------------------|
| engine | Turbocharge | A                              | $\Phi 101.890 - \Phi 101.900$ |
|        | B           | $>\Phi 101.900 - \Phi 101.910$ |                               |
|        | C           | $>\Phi 101.910 - \Phi 101.920$ |                               |
|        | D           | $>\Phi 101.920 - \Phi 101.930$ |                               |

\* 100 series, 105 series is similar with this.

\* 4100ZLQ diesel engine is the same with non turbo-charge.

|   |   |                                |
|---|---|--------------------------------|
| Q | A | $\Phi 101.940 - \Phi 101.950$  |
|   | B | $>\Phi 101.950 - \Phi 101.960$ |
|   | C | $>\Phi 101.960 - \Phi 101.970$ |
|   | D | $>\Phi 101.970 - \Phi 101.980$ |

② The clearance between piston and cylinder-block bush

|                                |           |
|--------------------------------|-----------|
| 4102Q                          | 0.07-0.09 |
| 102 series turbo-charge engine | 0.12-0.14 |
| The other engine               | 0.18-0.20 |

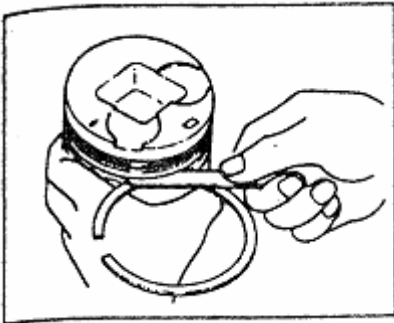

③ The clearance between piston ring and ring groove

|                 | Standard   | Limit value |
|-----------------|------------|-------------|
| The first ring  | 0.08-0.115 | 0.2         |
| The second ring | 0.03-0.065 | 0.15        |
| Oil ring        | 0.03-0.065 | 0.15        |

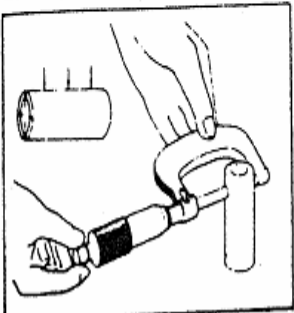
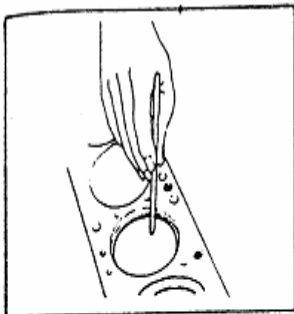

④ The opening clearance of piston ring

|                 | Standard  | Limit value |
|-----------------|-----------|-------------|
| The first ring  | 0.30-0.50 | 1.5         |
| The second ring | 0.20-0.40 | 1.5         |
| Oil ring        | 0.20-0.40 | 0.15        |

\* The first opening clearance of 102 series turbo-charge engine is 0.25-0.45.

\* The first opening clearance of 4102EZL is 0.45-0.65.

\* The first opening clearance of 100 series oil ring is 0.25-0.45.

⑤ The clearance between piston pin and pin hole

Piston pin diameter

| Group No. | Standard dimension            | Color  |
|-----------|-------------------------------|--------|
| 1         | $\Phi 35.000 - \Phi 34.997$   | Red    |
| 2         | $< \Phi 34.997 - \Phi 34.994$ | Yellow |
| 3         | $< \Phi 34.994 - \Phi 34.991$ | Blue   |

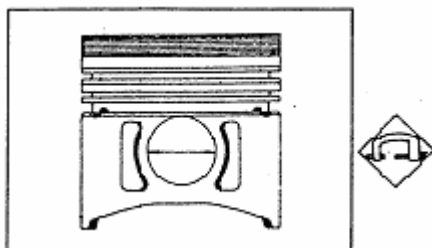

Inside diameter of piston pin hole

|   |                               |
|---|-------------------------------|
| 1 | $\Phi 35.007 - \Phi 35.003$   |
| 2 | $< \Phi 35.003 - \Phi 34.999$ |
| 3 | $< \Phi 34.999 - \Phi 34.995$ |

After grouping and assembly, the clearance:

|          |             |
|----------|-------------|
| Standard | 0.001-0.010 |
|----------|-------------|

13) Connect-rod, connect-rod shell and bush



- ① The clearance of the piston and connect-rod small end hole

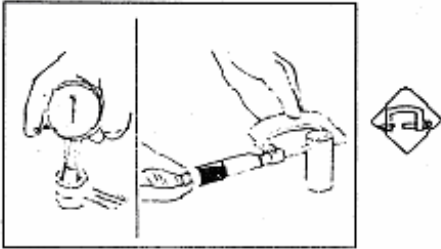

| Standard    | Limit |
|-------------|-------|
| 0.015-0.039 | 0.07  |

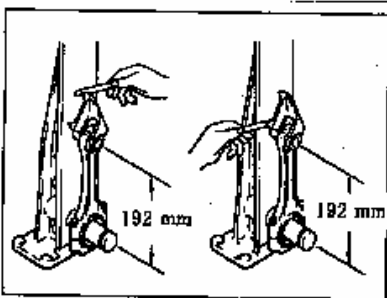

- ② Parallelism (double direction) of connect-rod big and small end hole

| Limit | 0.2/100 |
|-------|---------|
|-------|---------|

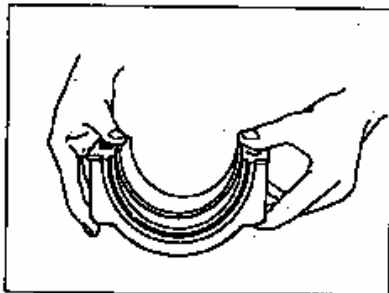

- ③ Free tension of connect-rod shell

If the shell has sufficient free tension, the finger should be with strength during installing it.

After installed, if it looses, you should replace it.

- 14) The clearance between connect-shell and crankshaft connect-rod journal

- ① Make connect-rod shell install

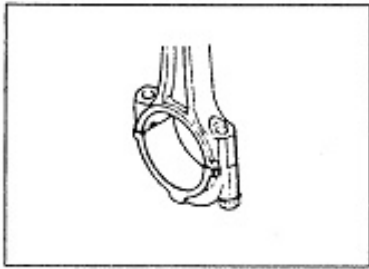

into the big end hole of connect rod, and make connect-rod screw bolt tight the stipulated torque according to requirements.

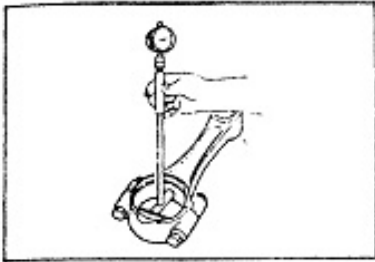

② After installed shells, the inside ter:

|                         |     |
|-------------------------|-----|
| Nominal inside diameter | Φ64 |
|-------------------------|-----|

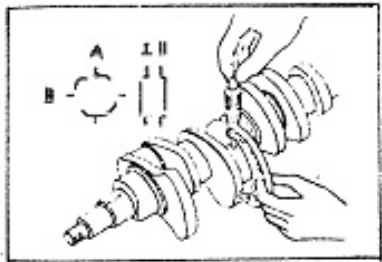

③The diameter of crankshaft connect-rod journal.

|          |                   |
|----------|-------------------|
| Standard | Φ63. 921-Φ63. 940 |
|----------|-------------------|

④ The clearance

| Standard     | Limit |
|--------------|-------|
| 0. 04-0. 098 | 0. 15 |

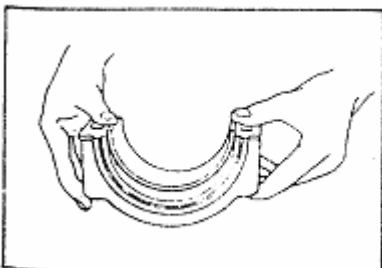

15) The clearance between the main bearing shell and the main bearing journal

① Free tension of the main bearing shell  
If the shell has sufficient free tension, the finger should be with strength during

installing it.

After installed, if it looses, you should replace it.



②Make the main bearing shell install into the main bearing hole, and make screw bolt of the main bearing tight the stipulated torque according to requirements

There is no oil groove on the main bearing shell under centre bottom.

③After installed the main bearing shell, the inside diameter of main bearing hole

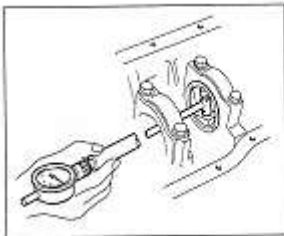

|                       |           |
|-----------------------|-----------|
| 4102Q                 | $\Phi 76$ |
| The other engine type | $\Phi 80$ |

④The diameter of the main journal of crankshaft

|                       |                             |
|-----------------------|-----------------------------|
| 4102Q                 | $\Phi 75.916 - \Phi 75.935$ |
| The other engine type | $\Phi 79.916 - \Phi 79.935$ |

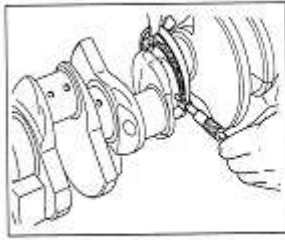

⑤ Axial clearance

| Type                  | Standard    | Limit |
|-----------------------|-------------|-------|
| 4102Q                 | 0.050-0.121 | 0.15  |
| The other engine type | 0.045-0.106 | 0.15  |

⑥ Axial clearance

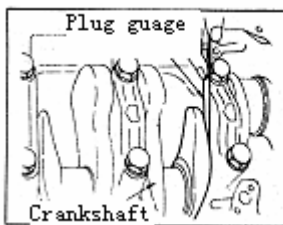

| Standard    | Limit |
|-------------|-------|
| 0.115-0.256 | 0.4   |

⑦ Axial beat of crankshaft main journal

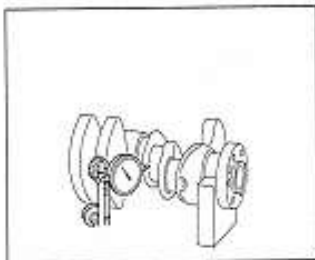

Measure the beat of every journal in the middle with V iron supporting the journal of two ends.

| Standard | Limit |
|----------|-------|
| 0.05     | 0.4   |

17) Regrinding crankshaft and making shell increase thickness

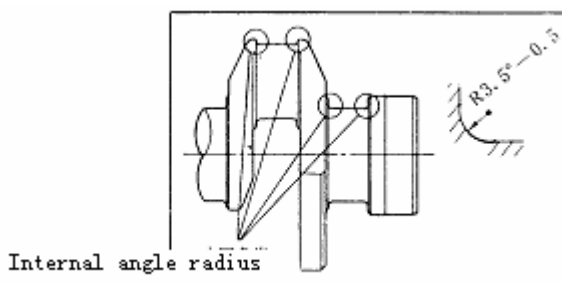

Internal angle radius

① Because of the deviation of dimension and shape, permit

regrinding crankshaft, regrinding shorten

dimension is 0.5 and 1.0 two grades.

Fillet radius of the main journal and connect-rod journal is  $R3.5^{0}_{-0.5}$

② The dimension of increasing thickness shell

Increasing thickness dimension of crankshaft is permitted two grades.

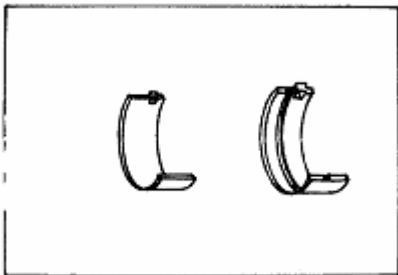

|                                |              |
|--------------------------------|--------------|
| Increasing thickness dimension | 0.25 and 0.5 |
|--------------------------------|--------------|

18) Crankshaft gear

The clearance of crankshaft gear

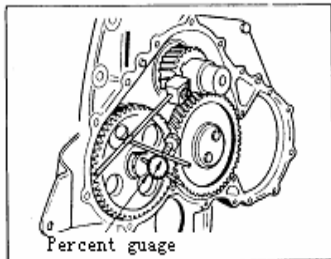

| Standard  | Limit |
|-----------|-------|
| 0.10-0.18 | 0.35  |

If crankshaft gear existed wear, abnormal phenomenon or side clearance exceeded limit, should replace it.

19) Flywheel joint

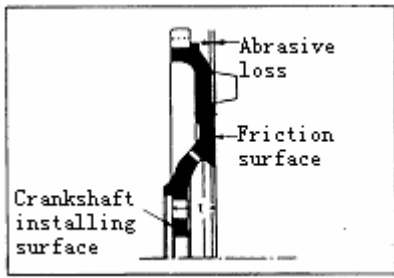

① Flywheel friction, the surface existed wear.

Permit wear limit value is 1.5.

② Gear ring

Because gear ring wore heavily and made it not start, should replace it.

# Disassembly, repairing and adjusting for auxiliary parts

## 1 Lubrication system

### 1) Forced lubrication system diagram

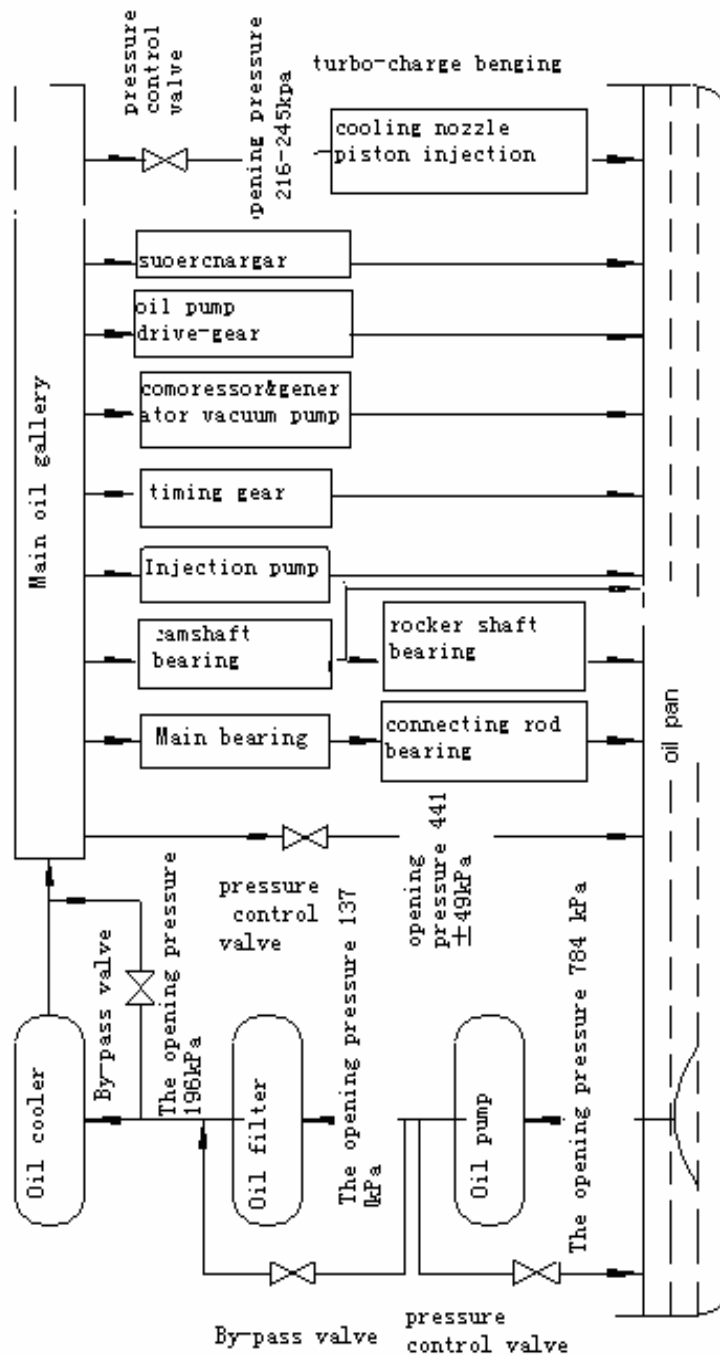

## 2) Oil pump

2) 机油泵

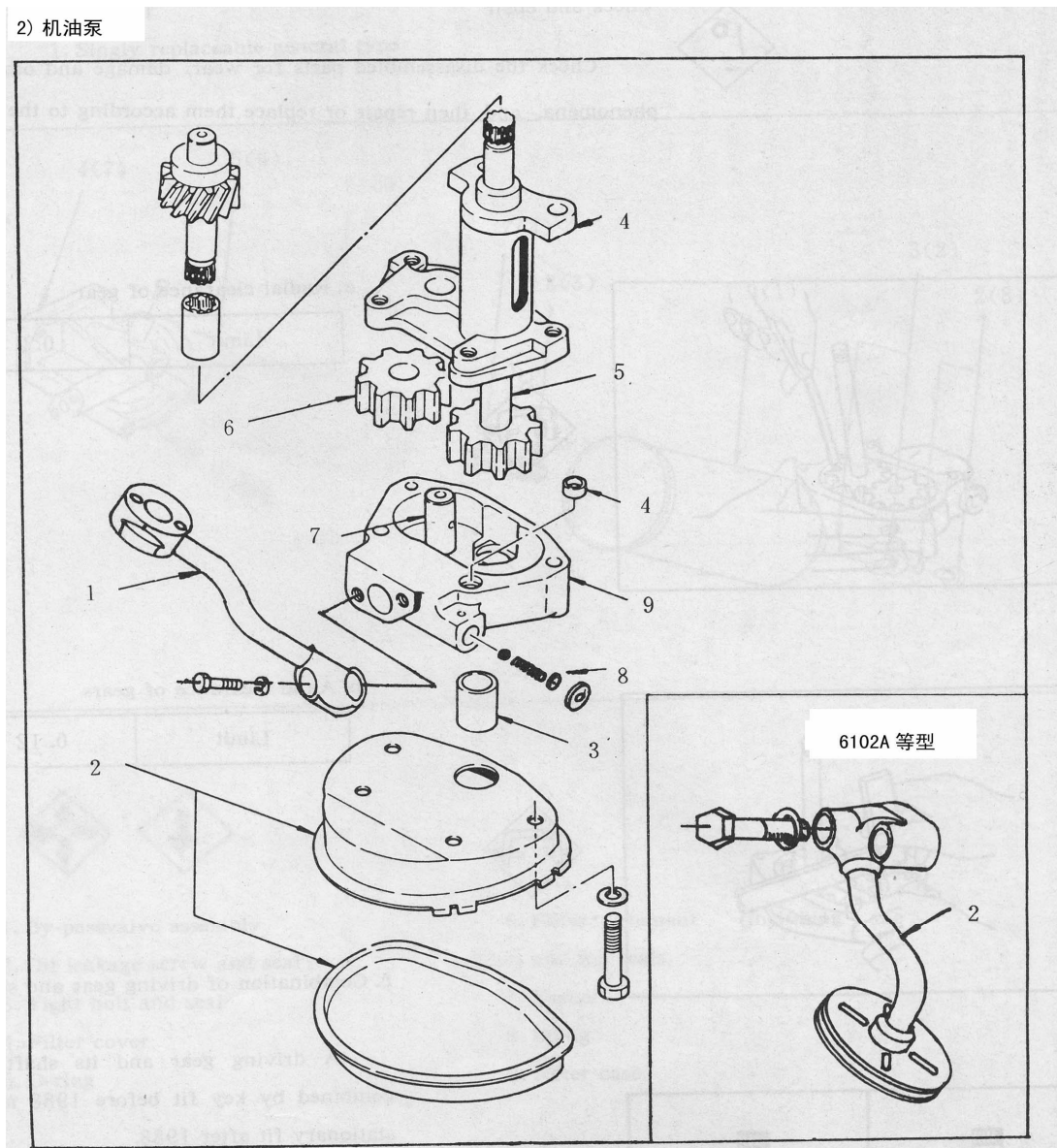

1. Oil pipe joint

2. Filter

3. Suction pipe

4. Oil pump cover and  
locating pin



5. Driving gear and shaft

6. Driven gear

7. Driven gear shaft

8. Restricting pressure  
valve assembly parts

9. Pump body



In principle assembly order is counter clock with disassembly order.

After finished assembly, if the condition permits, should carry out performance test and adjust, check and repair to the restricting pressure valve.

Check all disassembly spare parts, and see if there are wear, damage and the other abnormal phenomenon, and repair and replace spare parts according to practice.



① Radial clearance of gear

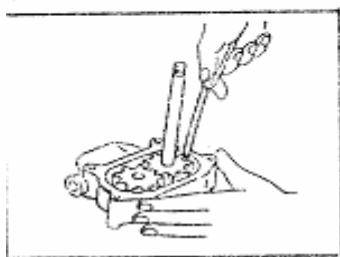

|       |     |
|-------|-----|
| Limit | 0.2 |
|-------|-----|



② Axial clearance of gear

|       |      |
|-------|------|
| Limit | 0.12 |
|-------|------|

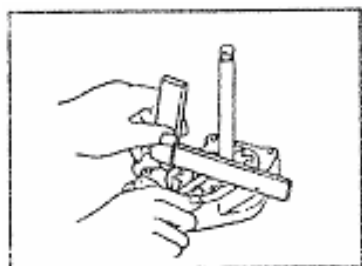

③ Joint between driving gear and shaft

Before 1988, the connection of driving gear and shaft of the products is with keys. The

connection of later products is with interference coordinating. Gear, shaft and interference coordinating:

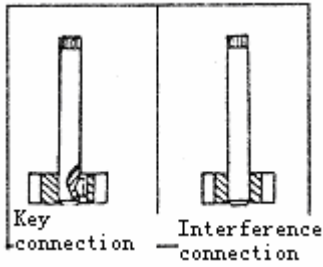

|       |      |
|-------|------|
| Limit | 0.20 |
|-------|------|

Min. torque that they produced relative slide:

|             |       |
|-------------|-------|
| Limit (N.m) | > 200 |
|-------------|-------|

### 3) Oil filter

① General method that can be replaced separately filter element.

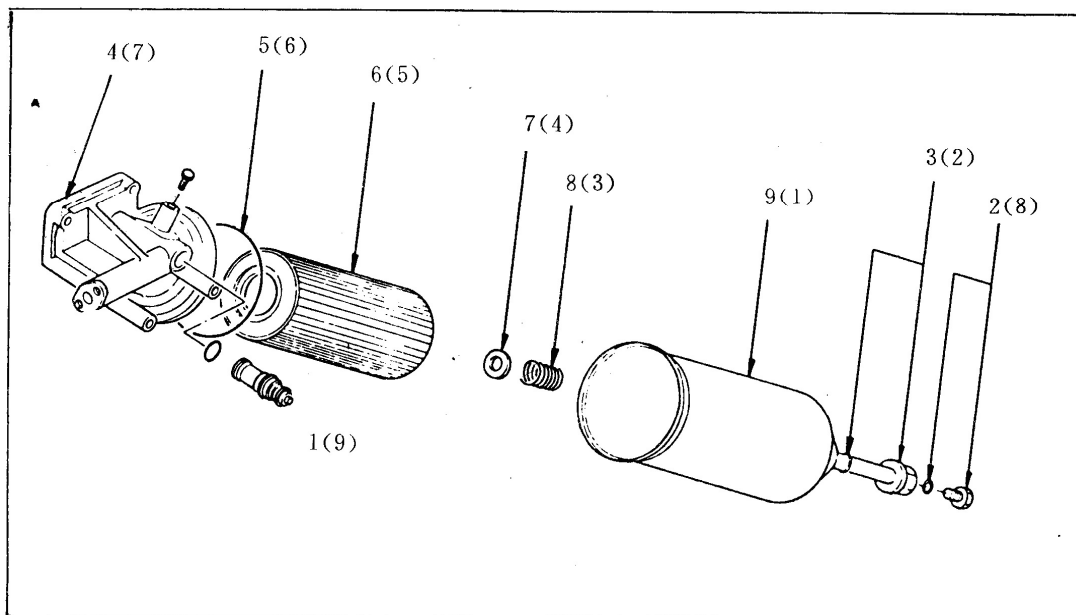



- |                                  |   |
|----------------------------------|---|
| 1. By-pass valve joint           | 6. The joint of element                                     |
| 2. Drain oil screw and seal ring | (including below end seal ring and the top cover seal ring) |
| 3. Straining screw and seal ring | 7. Gasket   |
| 4. Filter seat (top cover)       | 8. Spring   |
| 5. "O" seal ring                 | 9. Oil filter case body                                     |



- (1) Oil filter case body
- (2) Straining screw and seal ring
- (3) Spring
- (4) Gasket
- (5) Element joint (including below seal ring and top cover seal ring).
- (6) "O" seal ring
- (7) Filter seat

( At the same make straining screw spin inside and tight).

- (8) Drain oil screw and seal ring

(9) The joint of by-pass valve

Check and repair

Check all disassembly spare parts, and see if there are wear, damage or jam and the other abnormal phenomenon, especially filter element and seal ring, and replace in time according to practice.

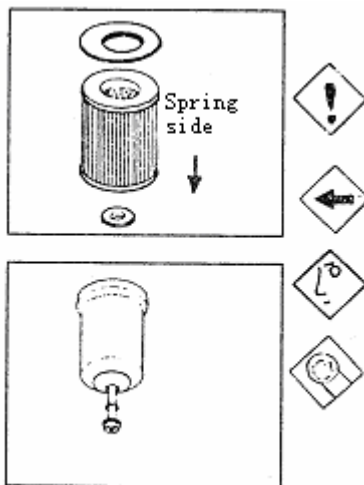

The opening pressure of by-pass valve: 140kPa.

a. When install filter element, don' t forget up and down seal ring, and pay attention not to installing wrong.

b. Straining screw

|               |       |
|---------------|-------|
| Torque (N. m) | 40-45 |
|---------------|-------|

② Spiral assembly

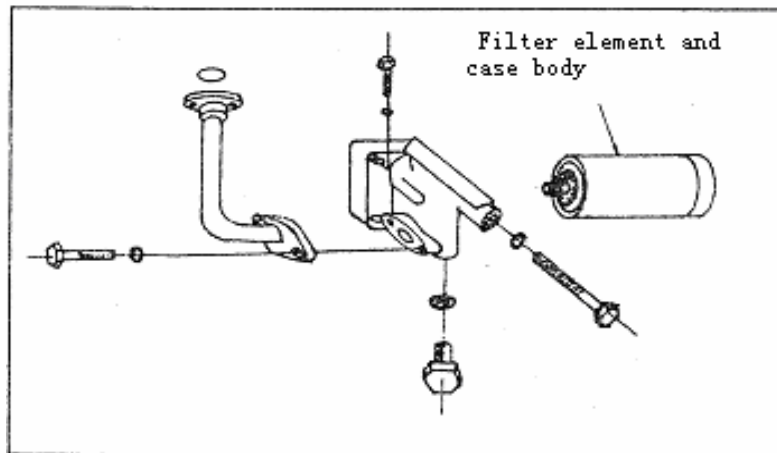

⚠ Replace filter element and case body together.

4) Oil cooler

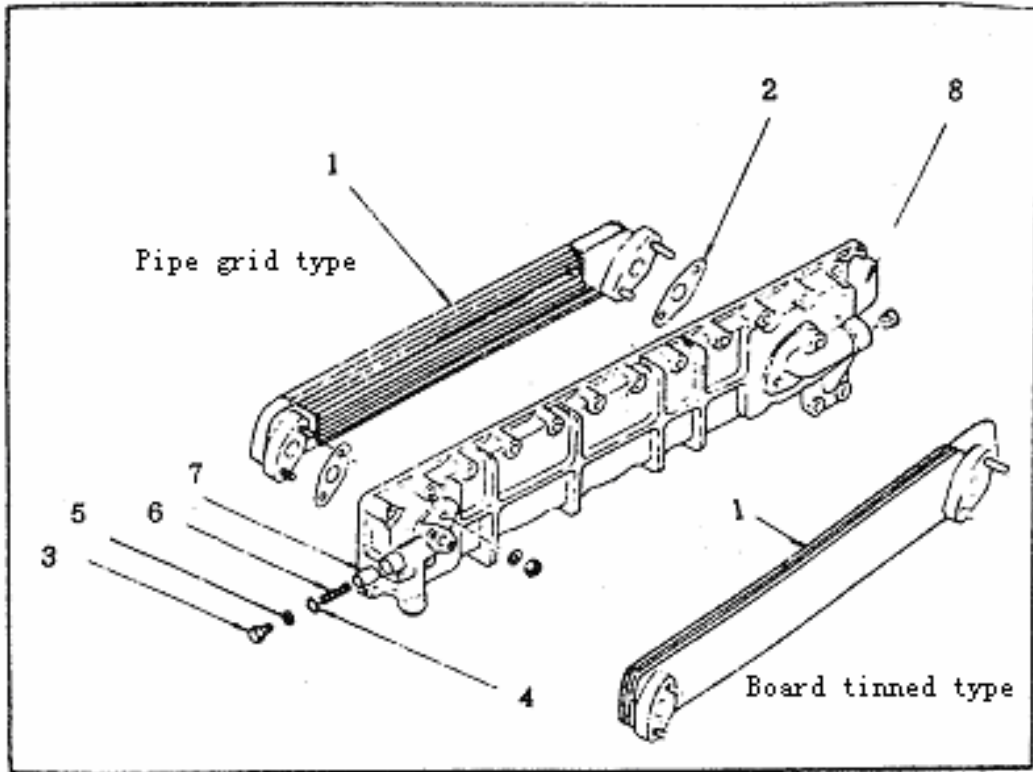

- |                              |                     |
|------------------------------|---------------------|
| 1. Cooler element joint      | 5. Gasket           |
| 2. Gasket                    | 6. Adjusting spring |
| 3. Adjusting pressure spring | 7. Slide valve seat |
| 4. Seal ring                 | 8. Oil cooler cover |



In principle assembly order is counter clock with disassembly order.

Check all disassembly spare parts, and see if there are wear, damage and the other abnormal



phenomenon, especially if cooler element is unobstructed. If necessary, and repair and replace spare parts according to practice.

The opening pressure of by-pass valve: 196 kPa.

## 2 Cooling system

### 1) Cooling system diagram of diesel engine

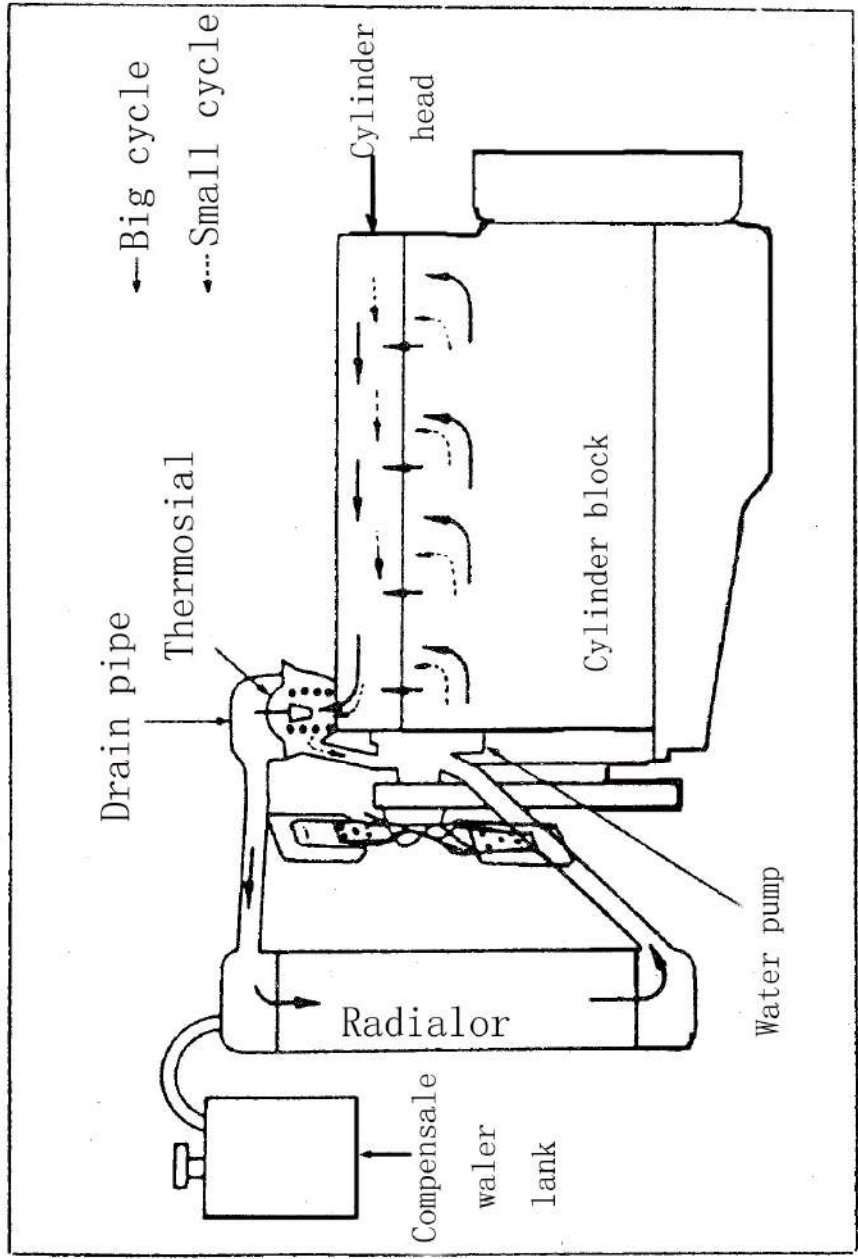

2) Water pump



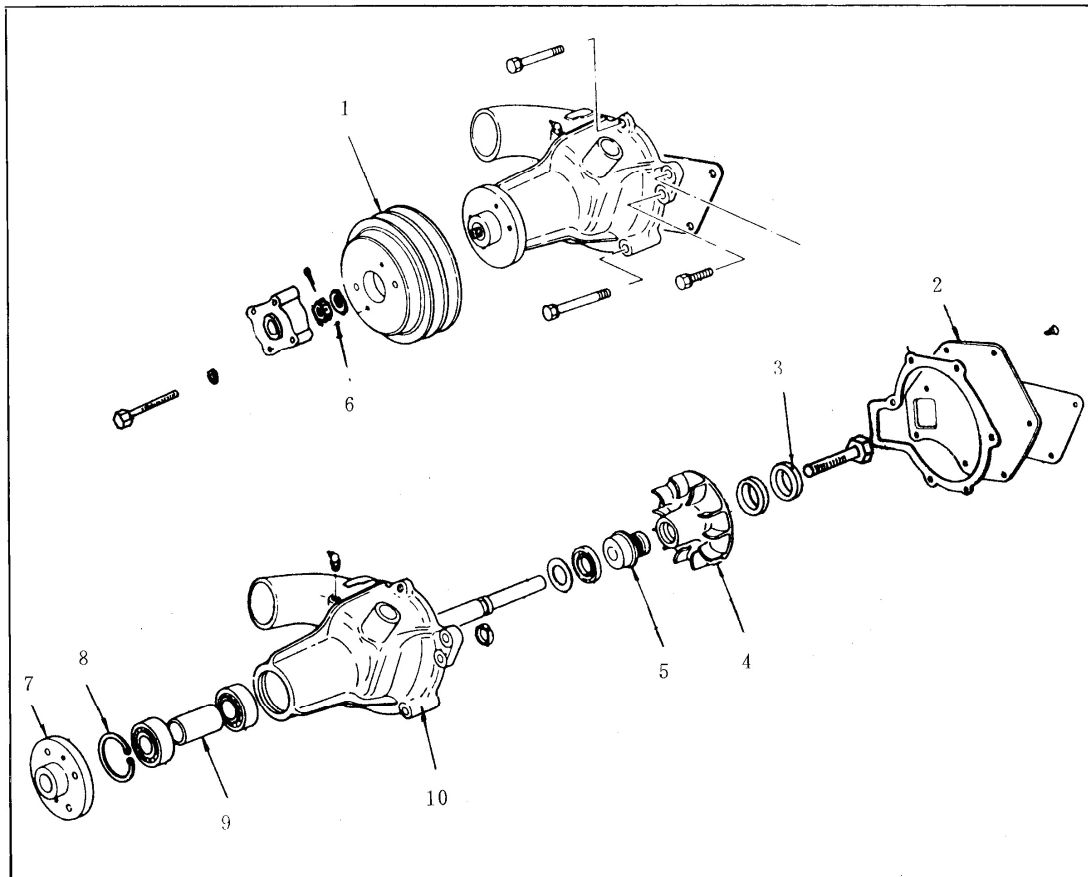

1. Belt pulley and fan joint seat
2. Water pump cover plate and water body gasket
3. Bolt, water pump shaft seal ring assembly parts
4. Water pump vane
5. The moving ring and static ring of water seal
6. Cotter and nut assembly
7. Belt pulley flange
8. Check ring
9. Water pump shaft, bearing and check ring sleeve assembly
10. Water pump body



In principle assembly order  
is counter clock with disassembly  
order.



\*Instruction: Water pump configuration of every engine type is different, some are with joint seat, some are installed fan clutch in the front, some flange between water pump shaft and belt pulley connected with keys, some connected with flat column, but the configuration is same.

When disassembly, note:

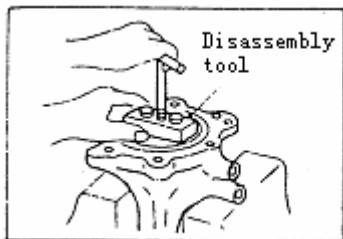

① Vane

Pull out vane with two technologies screw hole and disassembly tool.

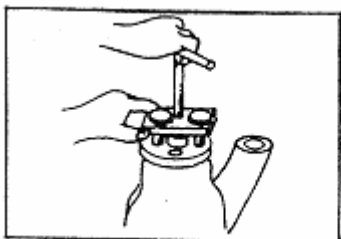

② Belt pulley flange

Pull out belt pulley flange by the disassembly tool with four screw holes.

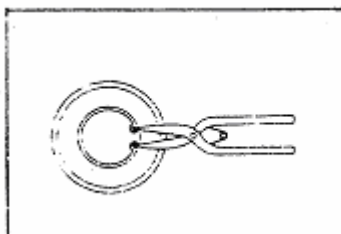

③ Check ring

Disassembly check ring with check ring pliers.

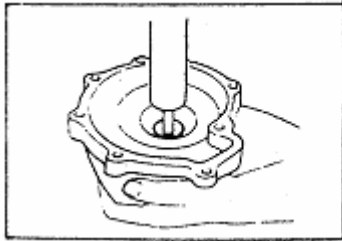

④ Water pump shaft, bearing and check ring assembly

Compress out shaft, bearing and check ring with core bar and pressure machine.



When assembly, must note:

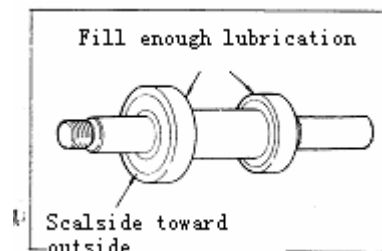

① Water pump shaft, bearing and check ring assembly



Before make water pump shaft, bearing and check bush install into water pump, should fill adequate lubrication crease.

Make water shaft, bearing and check bush install water pump with pressure machine and the right tool.

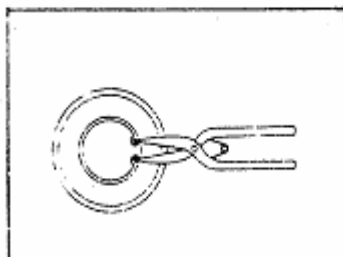

② Check ring



Make check ring install into water pump with check ring pliers.

③ Belt pulley flange

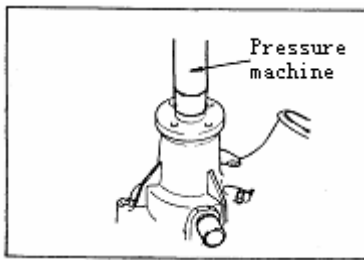

Make belt pulley flange install into water pump shaft with pressure machine and the right tool.

④ Nut and cotter

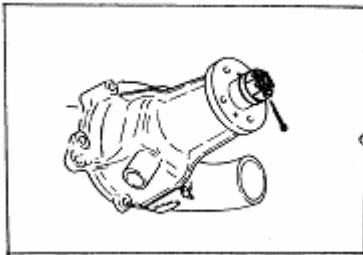

Make the belt pulley flange lock with bolt or special tool, and tight nut to the stipulating moment (bearing lock washer closed with bearing), then put on the cotter.

|              |       |
|--------------|-------|
| Torque (N.m) | 40-45 |
|--------------|-------|

⑤ Moving ring and static ring of water seal

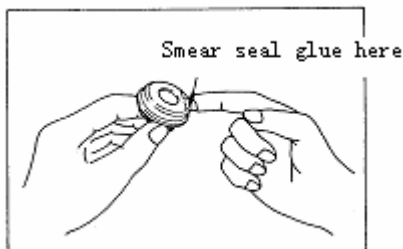

Before installing, the contact face between static ring and water body must be smeared seal glue

(liquid gasket).

### ⑥ Vane

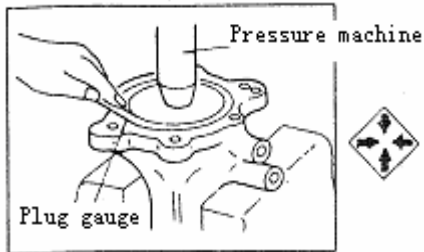

Install vane with pressure machine, and control the axial clearance between vane and pump with plug gauge.

|                    |         |
|--------------------|---------|
| Standard clearance | 0.3-0.7 |
|--------------------|---------|

### Check and repair

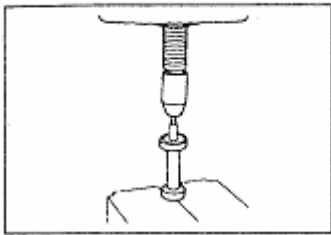

Check all disassembly spare parts, and see if there are wear, damage and the other abnormal phenomenon. If necessary, and repair and replace spare parts according to practice.

### Replace bearing

Extrude bearing and cylinder-bush from water pump with pressure machine, and make bearing close with lock washer.

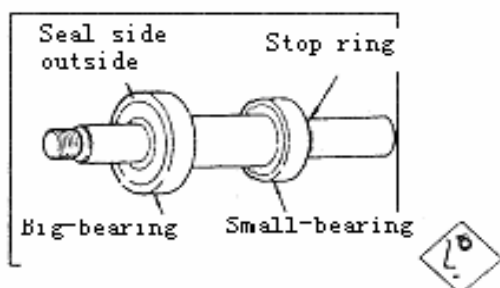

### 3) Thermostat

Thermostat includes bottom-pass and by-pass.

When assembly, pay attention to the seal gasket.

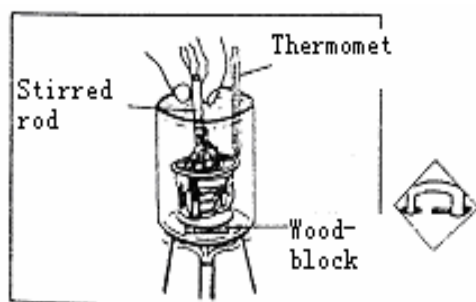

### Check

Check the opening temperature and lift of thermostat, when it is unconfornity, must replace it.

### The opening temperature

|                              |                            |
|------------------------------|----------------------------|
| Standard opening temperature | $72 \pm 2^{\circ}\text{C}$ |
|------------------------------|----------------------------|

### Lift

|               |  |
|---------------|--|
| Standard lift | When the temperature is $86^{\circ}\text{C}$ , it is more than 8mm |
|---------------|--|

### 3 Inlet and exhaust system

#### 1) Air filter

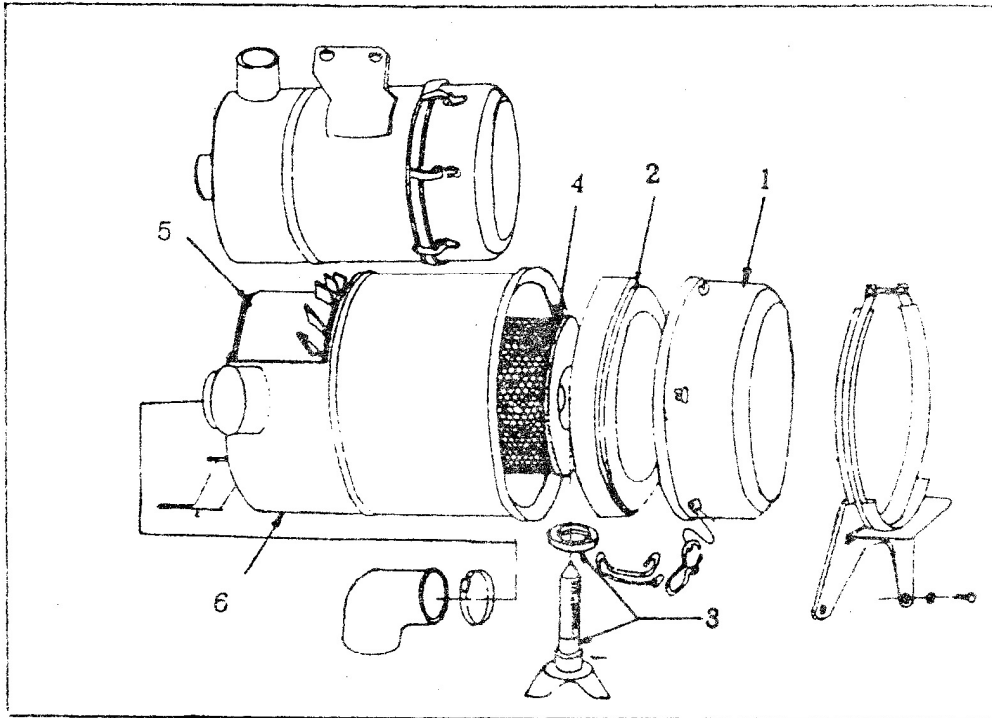

1. Dust tray
2. Dust tray cover and seal ring
3. The tighten screw of element and seal gasket
4. The element joint
5. Swirler and seal ring
6. Outer shell

In principle assembly order



is counter clock with disassembly order.

Air filter is very important to diesel engine, if the element is blocked, it will increase inlet resistance, and make power reduce, and increase oil consumption and black smoke in exhaust. When element of air filter and shell damage or short circuit caused invalidation, it will increase wear of diesel engine.

Clean element in time according following maintenance rules and manual requirements, and practical operation, and often check shell and element earnestly, see if there are wear, damage and the other abnormal phenomenon. If necessary, should repair and replace spare parts according to practice.

Note:

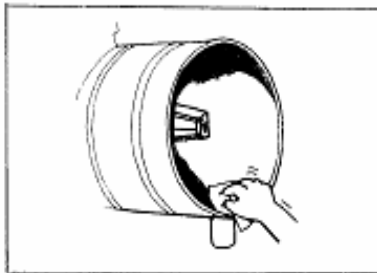

① Clean lumen of outer shell & lumen



After disassembly element, should wipe off dust in lumen of outer shell.

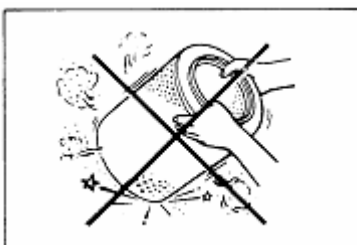

② Clean element



When remove from dust, don't impact, or it may cause deformation or damage.

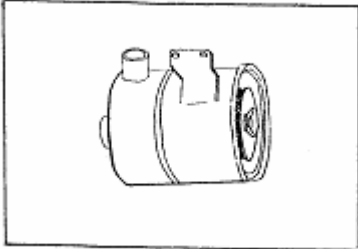

### ③ Assembly element

When assemble element, pay attention to put well seal ring, and tight screw, don't cause short circuit.

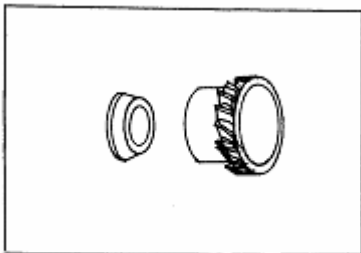

### ④ Replace swirler and seal ring

Must replace them in time, when swirler damages, and seal ring is deformation, aging and damage.

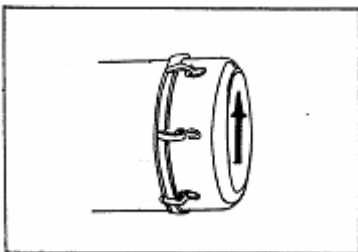

### ⑤ Installing dust tray

To transverse the air filter, make the arrow up when install dust tray (the opening inside dust tray cover should be up.)

## 2) Booster

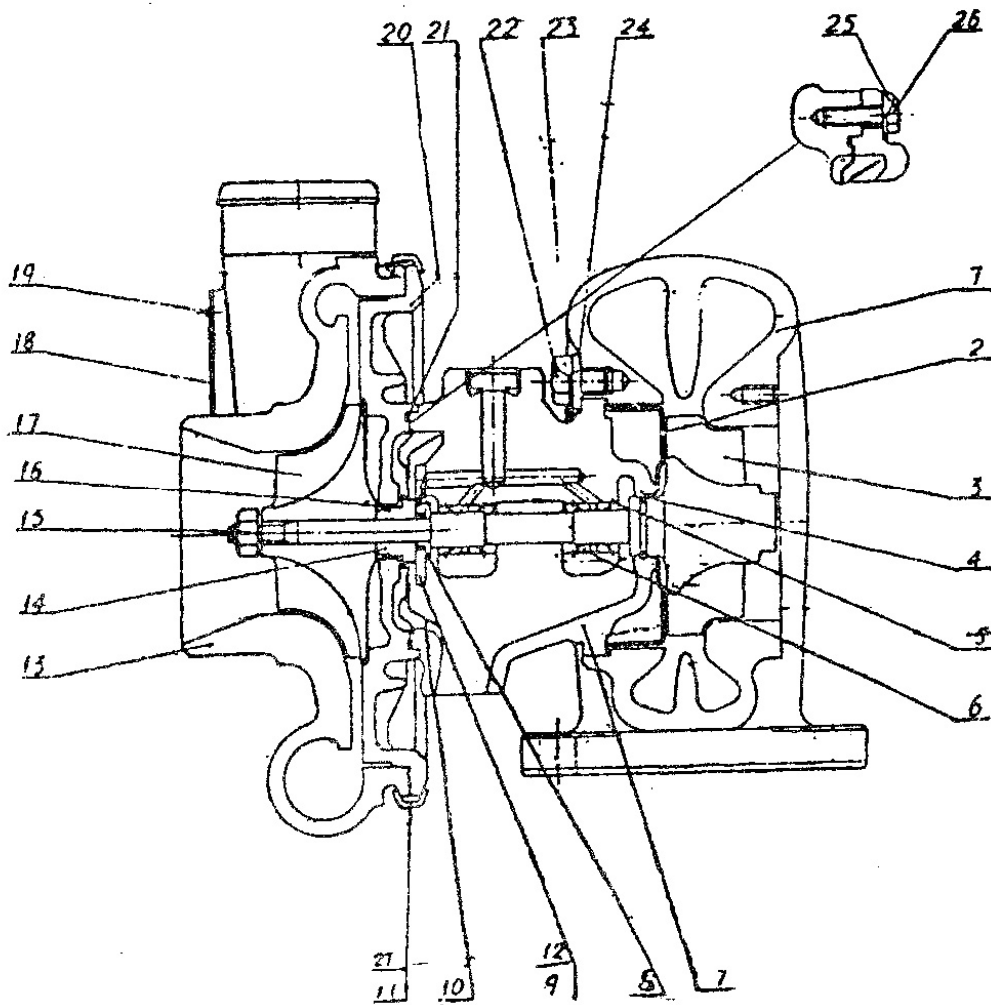

- |                         |  |
|-------------------------|--|
| 1. Housing of turbine   | 8. Distance thrust bush                    |
| 2. Insulation plate     | 9. Thrust bearing                          |
| 3. Turbine parts        | 10. Oil splasher parts                     |
| 4. Seal ring of turbine | 11. Shroud ring parts of<br>compressor end |
| 5. Bearing check ring   | 12. Flat screw                             |
| 6. Floating bearing     | 13. Compressor case                        |
| 7. The middle case      |  |

- |                             |                              |
|-----------------------------|------------------------------|
| 14. Shaft seal              | 22. Hexagon head screw       |
| 15. Lock nut                | 23. Locking piece of turbine |
| 16. Seal ring of compressor | case                         |
| end                         | 24. Turbine case compress    |
| 17. Compressor vane         | plate                        |
| 18. Nameplate               | 25. Locking piece of         |
| 19. Rivet                   | diffusion machine            |
| 20. Diffusion machine       | 26. Hexagon head screw       |
| 21. "0" seal ring           | 27. Hexagon head nut         |

#### Disassembly

See total section view for the disassembly turbine, and must disassembly in cleaning and drying place. And disassembly should be finished by the special persons.

- ① Disassembly compressor case (13)
- ② Disassembly turbine case (1)
- ③ Located by rose head of turbine parts, disassembly locking nut (15) and compressor vane (17).

Note: Thread is left wright, and pay attention to distortion direction, or will damage thread, and prevent to damage rotor head.

- ④ When disassemble diffusion machine, and take off diffusion machine (20) with shaft seal (14) together, and then take off

“0” seal ring (21), and then push out shaft seal from diffusion machine, at the same time take off seal ring of compressor end(16).

⑤ Take off oil splasher parts(10).

⑥ Pull out turbine rotor(3) slightly by hand, disassembly insulation plate(2), then take off seal ring on the end of turbine from rotor.

Note: When pull out turbine rotor, don' t scratch floating bearing (6).

⑦ Disassembly flat screw wit crosshead and rose opener(12), take out thrust bearing (9) and Distance thrust bush (8).

⑧ Take out bearing check ring on the end of pressure machine with check ring pliers, and take out floating bearing (6), then take out bearing check ring(5)from the end of turbine with check ring pliers, take out floating bearing (6), at last take out two bearing ring (5) in the bearing hole.

## Cleaning

Must clean turbo—charge spare part.

① Make spare parts dip in the cleaning agent(kerosene, diesel or gasoline) wash.

② Wash oil dirty with plastic scraper or hard brush.

③ Washed spare parts, especially the inside surface in case, all screw hole and air passage inside must blow dry with compress air.

Check

① Check vane of compressor machine and turbine, see if there are crack, bend, deformation or scrape, if it exists crack, bend, deformation or scrape, must replace and check dynamic balance again.

Note: Don' t use the vane again after make bend change straight.

② Check journal of seal rotor, side of turbine groove and seal ring, see if there are wear. If it exists wear heavily, must replace it.

③ Check thrust bearing, bearing seal, and distance thrust bush and so on, to see if there are wear. If it existed wear heavily, must replace it.

④ Check thrust bearing oil groove and inlet oil hole, see if it is cleaning.

⑤ Check inside and outside surface of floating bearing, see if there are gigging, wear and so on. If it exists wear heavily, must replace it.

⑥ Check "O" ring, see if there are hardening, permanence

deformation, surface side broken or damage and so on. If they are heavily, must replace it.

⑦ Check if there are crack and scrape, especially at the matching position with moving parts, see if there are impacting.

### Assembly

After replaced damage spare parts, must wash cleaning, then assemble them.

Assembly order of turbo-charge is counter clock with disassembly order, we will not repeat. Only introduce the notes of assembly:

① Assembly requirements for turbine rotor (See the following drawing.)

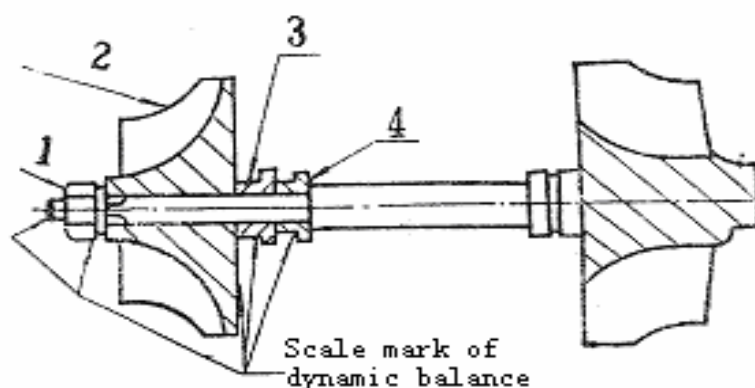

Assembly dynamic balance emendation drawing for turbine rotor.

- |                |                         |
|----------------|-------------------------|
| 1. Locking nut | 2. Compressor vane      |
| 3. Shaft seal  | 4. Distance thrust bush |

Note: When tight locking nut at the end of compressor machine, should make the scale on the locking nut adjustification with the scale on the thread of rotor shaft and the scale on the vane of compressor machine. All moving scales must adjust to assemble.

② When assemble bearing check ring (5), pay attention to make the smooth bevel face floating bearing face.

③ Lubricate floating bearing, bearing hole of middle case, thrust bearing and distance thrust bush with cleaning lubrication oil.

④ When make turbine parts install into middle case (7), pay attention to the opening of seal ring must face to the inlet direction, compress inside slightly, don' t knock.

⑤ When assemble flat screw (12), tighten torque 4.5 N.m.

⑥ When assemble locking nut(15), tighten torque 14 N.m.

Note: Wrest thread to left.

⑦ When assemble screw (26) of diffeusion machine, tighten torque 5.7 N.m.

⑧ Assemble hexagon head nut (27) on the hitching parts of the compressor machine and hexagon head screw (22) on the turbine case, tighten torque 11.3 N.m.

⑨ Finished assembly, fill the right lubrication oil into the

inlet oil hole of middle case, and turn turbine rotor by hand, it should move flexibly, no abnormal noise or stopping.

⑩ check axial moving gap of rotor and radial min. clearance of compressor, should meet following requirements:

| No. | Name                                   | Assembly clearance (mm) |
|-----|--|-------------------------|
| 1   | Radial min. clearance of<br>compressor | More than 0.195         |
| 2   | Axial moving gap                       | 0.038-0.093             |



## 4 Fuel systems

### Fuel supply diagram 1)

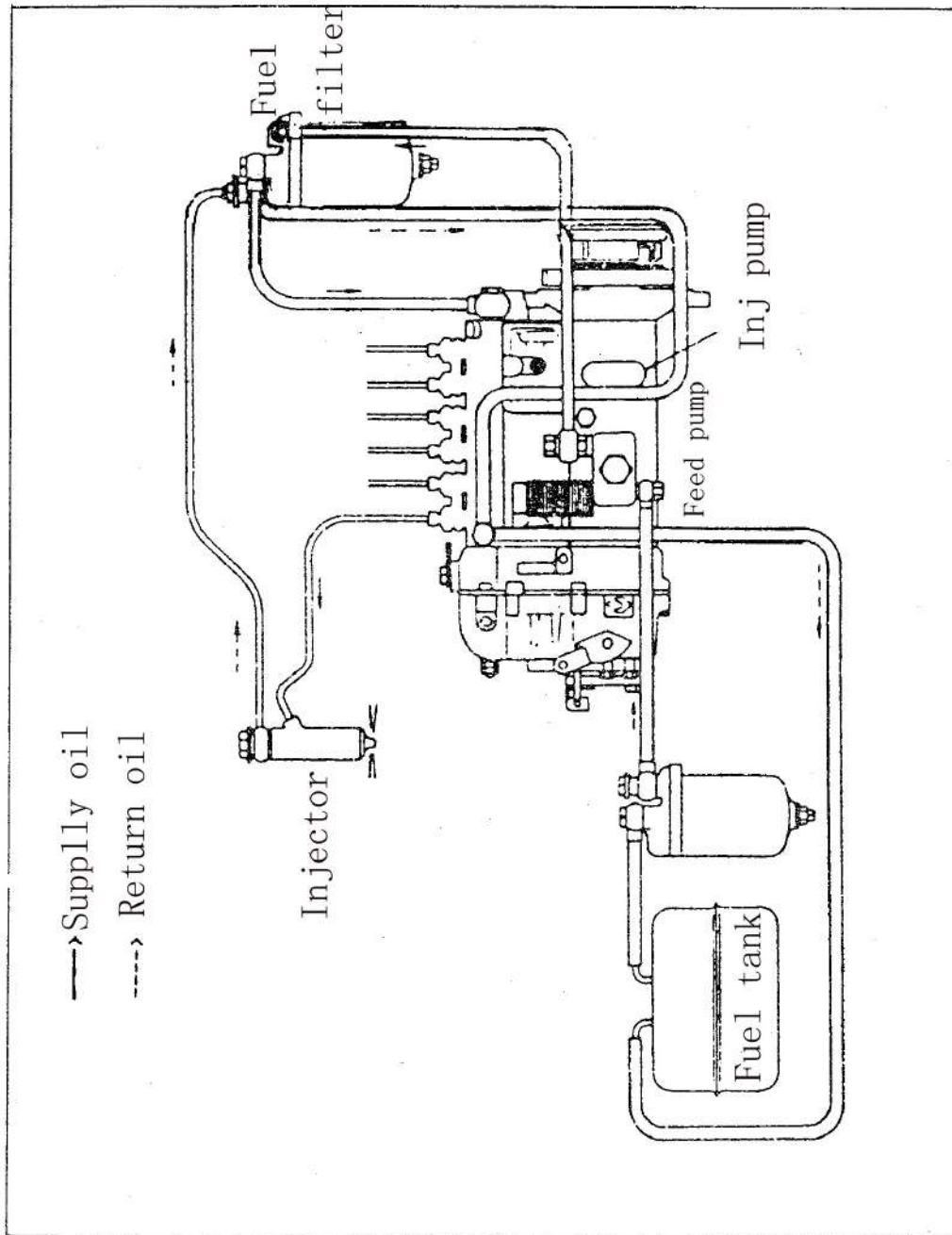

## 2) Fuel filter

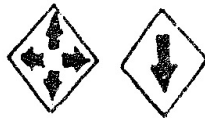
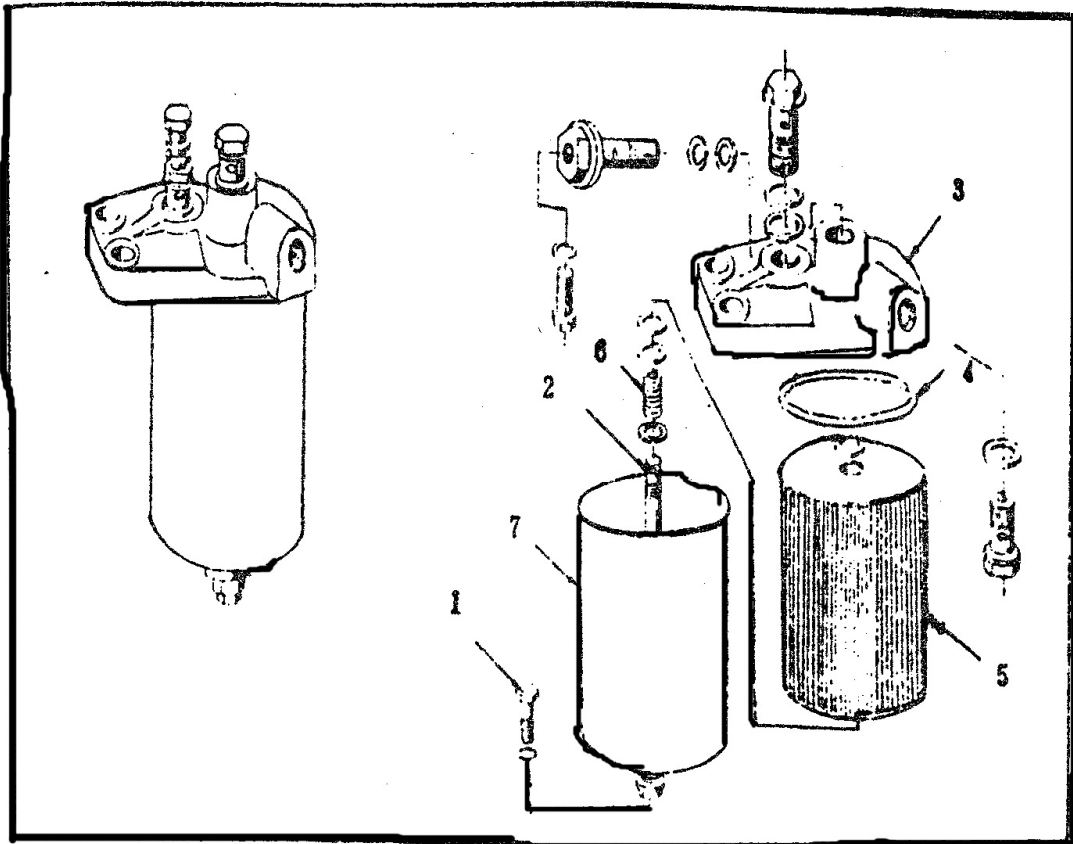

1. Exhaust dirty screw and "O" seal gasket
2. Pull lever and "O" seal gasket
3. Filter seat
4. Rubber gasket
5. Element (including rubber)
6. Gasket and spring
7. Outside case





Check all disassembly parts, especially filter



element and seal part, if found damage, deformation, invalidation and the other abnormal phenomenon, repair and replace them according to practice and requirements.

Replace filter according to stipulates.

When assemble, pay attention to inside seal, can' t occur short circuit.

### 3) Injector

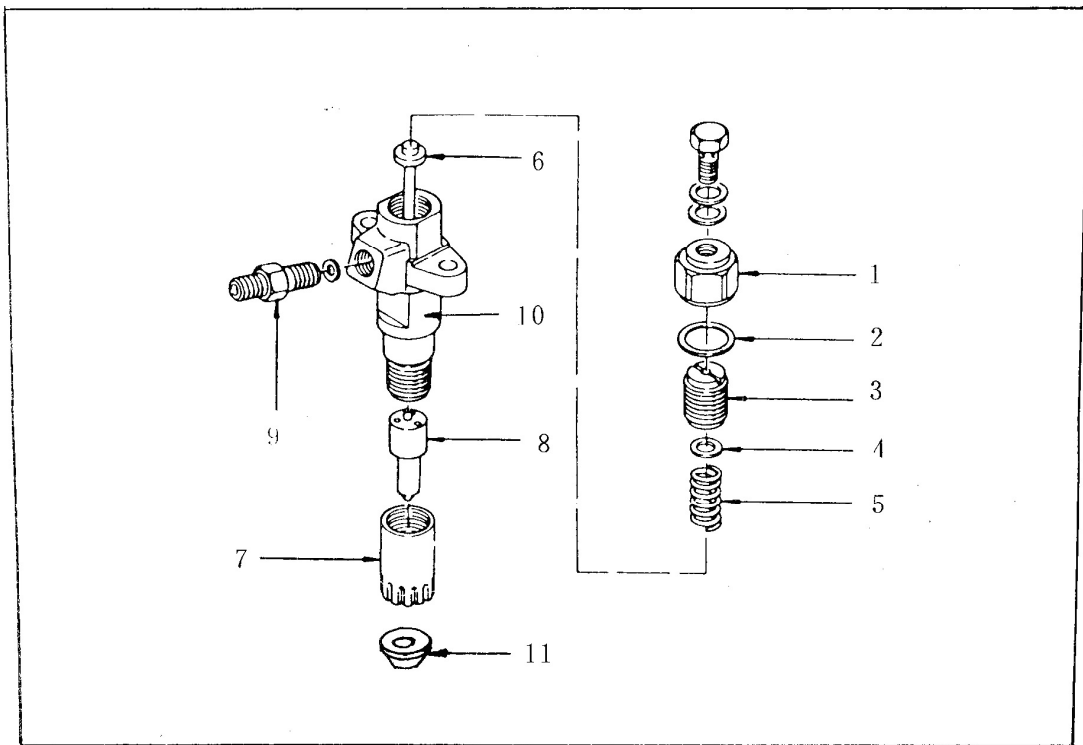

- |                                 |   |
|---------------------------------|---|
| 1. Nut                          | 7. Seal cone-shape<br>gasket                |
| 2. Gasket                       | 8. Injector nut                             |
| 3. Adjusting pressure<br>screw  | 9. Coupling parts                           |
| 4. Gasket                       | 10. Jointer of inlet oil<br>pipe and gasket |
| 5. Adjusting pressure<br>spring | 11. Injector assembly                       |
| 6. Top lever assembly           |   |



When disassemble, must put well coupling parts,



don't make wrong, ensure needle valve to match with valve body.

When assemble again, seal cone-shape gasket must change new one.

When assemble again, must note:

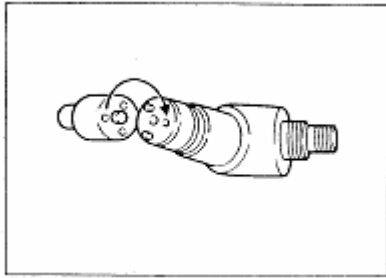

① Locating pin

Locating pin on the injector should be installed in pin hole of valve body.

② Injector nut

Tight them according to the stipulate torque.

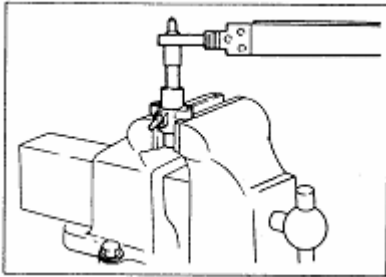

|               |       |
|---------------|-------|
| Torque (N. m) | 60-80 |
|---------------|-------|

③ Adjusting pressure screw

Adjust injection oil pressure and check spray.

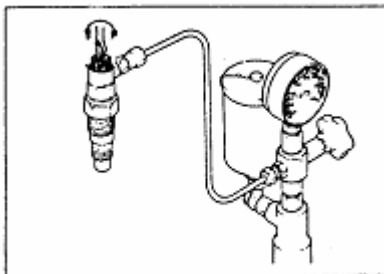

|                             |         |
|-----------------------------|---------|
| Injection pressure<br>(Mpa) | 19 ±0.5 |
|-----------------------------|---------|

The opening pressures for different engine types are

different, the detail value must read the operation manual of correspondence engine.

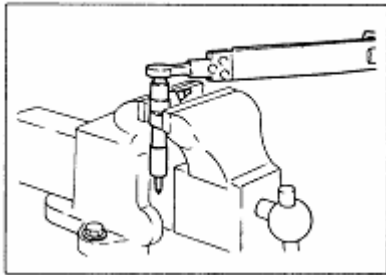

④ Nut

Tight them according to the stipulated torque.



|               |       |
|---------------|-------|
| Torque (N. m) | 40-50 |
|---------------|-------|

Check and repair

① Check all disassembly spare parts, and see if there are wear, damage and the other abnormal phenomenon. If necessary, and repair and replace spare parts according to practice.

② Wash all parts with cleaning diesel, and grind coupling parts with oil ( or according to practice, use grinding cream ).

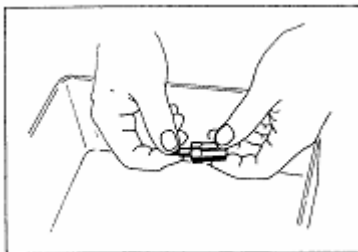

When there exist carbon between injection hole and needle valves, must eliminate carbon.

Eliminate carbon on the cone-shape gasket, if necessary, must replace.

Before disassembly, and after assembly again, check and adjust injection pressure must spray.

① Injection oil pressure

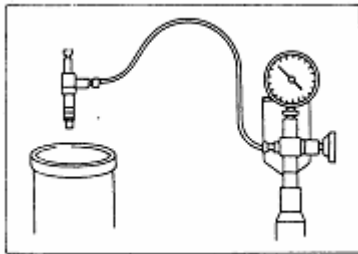

Check (or adjust) the opening pressure of injection with test equipment of injector.

|                                 |         |
|---------------------------------|---------|
| Injection oil pressure<br>(Mpa) | 19 ±0.5 |
|---------------------------------|---------|

The opening pressures for different engine types are different, the detail value must read the operation manual of correspondence engine.

② Leakage

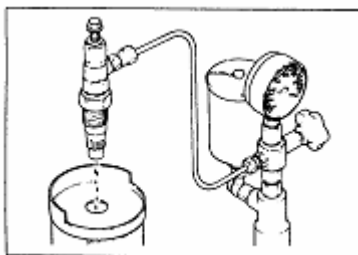

Keep pressure 1.6MPa with test equipment of injector. If there is no leakage, it showed well.

③ Spray status

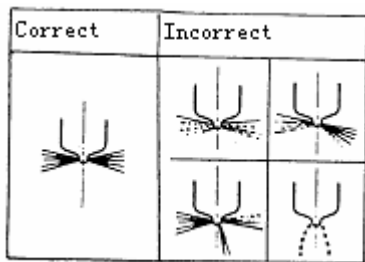

After oil circuit filled oil, use test equipment of injector to check spray status of injector at turning 4-6 times every second.

4) Injection pump (including deliver oil pump, governor, supplying automatic advancer)

① Basic data and instruction

Injection pumps are BOSCH A type, AD type strengthen pump, P type pump or VE distribution pump. The main manufacture factories: WUXI OIL PUMP & OIL NOZZLE FACTORY, DALIAN OIL PUMP & OIL NOZZLE FACTORY, BEIJING OIL PUMP & OIL NOZZLE FACTORY and so on, only a little need to import, the manufacture factory: JAPAN D. K. K Company.

Pre-lift: **2.2 ±0.05 (6102)**

**3.4±0.05 (4102Q、4102BG)**

**3.6±0.05 (4102BQ)**

**3.5±0.05 (4102BZLQ-A)**

**3.5±0.05 (6102BZLQ)**

**3.3±0.05 (4102EZLQ, VE Pump)**

**4.8 ±0.05 (4102EZLQ, PW pump)**

**4.0±0.05(4100ZLQ)**

**Fire order: 1-5-3-6-2-4 (six cylinders) ; 1-3-2-4 (four cylinders)**



Supply space angle of every cylinder :  $60^{\circ} \pm 30'$  (six cylinders)

$90^{\circ} \pm 30'$  (four cylinders)

High pressure oil pipe: unit: mm

| Engine type                    | Spec. (inside diameter $\times$ outside diameter $\times$ length)  |
|--------------------------------|--|
| 4100                           | $\Phi 2 \times \Phi 6 \times \Phi 450$   |
| 4100ZLQ                        | $\Phi 2 \times \Phi 6 \times \Phi 400$   |
| 4100BZLQ-A                     | $\Phi 2 \times \Phi 7 \times \Phi 500$   |
| 4102EZLQ                       | $\Phi 2 \times \Phi 6 \times \Phi 540$ (VE pump)   |
|                                | $\Phi 2 \times \Phi 6 \times \Phi 500$ (PW pump)   |
| 6102BZLQ                       | $\Phi 2 \times \Phi 6 \times \Phi 380$ (23° injector)<br>$\Phi 2 \times \Phi 6 \times \Phi 400$ (14° injector) |
| The other six cylinder engine  | $\Phi 2 \times \Phi 6 \times \Phi 580$   |
| The other four cylinder engine | $\Phi 2 \times \Phi 6 \times \Phi 400$   |

Plunger diameter spec. of injection pump:

| Plunger diameter (MM) | $\Phi 8.5$   | $\Phi 9$   | $\Phi 9.5$  | $\Phi 10$ | 10.5                                       | $\Phi 11$ | $\Phi 12$          |
|-----------------------|--|--|---|-----------|--|-----------|--------------------|
| Applying Engine       | 6102Q<br>6102AQ<br>6102G<br>6102G <sub>1</sub><br>6102G <sub>2</sub><br>4102BG | 4100Q<br>6102BQ<br>6102BQ <sub>1</sub><br>6102BG<br>6102BG <sub>1</sub><br>4102Q | 6102B <sub>1</sub> Q<br>4102BQ<br>4105Q<br>6105Q<br>6102BZQ | 6102BZQ   | 4100ZLQ<br>4102BZLQ-A<br>4102EZLQ(PW pump) | 6102BZLQ  | 4102EZLQ (VE pump) |

**Governing:** In general RAD type is two-grade for vehicle engine, RFP full-range two-grade two-usage, the special type is RLD full-range, the full-range are for the diesel engine of engineering mechanism.

**Delivery pump: piston type, when delivery oil pressure is 160kPa, 100r/min, supplying oil is 120ml/min.**

**The character of advanced angle of supplying oil automatic advancer:**

**4.8 ± 0.7/500-1500r/min (6102、 6102BZQ)**

**4.0 ± 0.5/1200-1750r/min (4102Q)**

**5.0 ± 0.5/500-1600r/min (4102BQ)**

**42.0 ± 0.5/500-1400r/min (6102BZQ)**

## **② Repairing and adjusting of injection pump**

**When diesel engine left factory, injector was adjusted well and lead sealing, so customers don't disassemble it at will. If want to repair and adjust, must do at the test table of injection pump in the special repairing factory.**

**The specific cylinder's supplying oil is uneven, you can adjust plunger sleeve. But the starting point of supplying oil or space angle is not right, you need to adjust gasket on the roller.**

**When disassemble plunger, don't make coupling parts make wrong in order to ensure the original assembly.**

**Tight outlet oil valve seat according to stipulates torque, the torque is not too big or too small.**

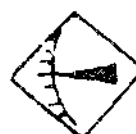

|                     |              |
|---------------------|--------------|
| <b>Torque (N.m)</b> | <b>30-40</b> |
|---------------------|--------------|

**Adjust injection pump according to characteristic curve and oil data table.**

**Standard conditions: Delivery oil pressure 160kPa.**

**Test oil: 10# or 20# light fuel**

**Oil temperature: 40°C-45°C.**

**Injection oil pressure:**

**The opening injection pressure for standard injector is 17 Mpa.**

### **③ Repairing and adjusting for VE pump**

**VE injection pump is with booster compensating equipment LDA and cool starting accelerator KSB. The full-load supply oil under the super-charge pressure was adjusted by full-load supplying oil adjusting screw in the accelerator cover. When test, cool start accelerator KSB must keep electrifying all the time.**

**When adjust it, you must use special standard injector for VE pump, the opening pressure is 14.7 Mpa (150kgf/cm<sup>2</sup>), delivery oil pressure 19.6 KPa (0.2kgf/cm<sup>2</sup>), VE pump special standard high pressure oil pipe. When the oil temperature is 38-42°C, adjust the data according to supplying injection oil quantity.**

6102 injection oil quantity adjustable data table

| Enginet type         | Adjust point | Rack stroke<br>mm | pump speed<br>r/min | Average supplying oil<br>mL/1000St | Unevenvalue % |
|----------------------|--------------|-------------------|---------------------|------------------------------------|---------------|
| 6102Q                | A            | 11                | 1400                | 54.0±1.4                           | ±2.5          |
|                      | B            | 11.1              | 1000                | 49.6±2.0                           | ±4            |
|                      | C            | ≈8.2              | 300                 | 9.4±1.3                            | ±14           |
|                      | D            |                   | 100                 | 60.5 以上                            |               |
| 6102AQ               | A            | 10.9              | 1500                | 55.5±1.5                           | ±2.5          |
|                      | B            | 11.0              | 1000                | 51.2±2.0                           | ±4            |
|                      | C            | ≈7.7              | 300                 | 9.4±1.3                            | ±14           |
|                      | D            |                   | 100                 | 60.5 以上                            |               |
| 6102BQ               | A            | 11.3              | 1500                | 65.0±1.6                           | ±2.5          |
|                      | B            | 11.5              | 1000                | 58.5±2.3                           | ±4            |
|                      | C            | ≈8.6              | 300                 | 9.4±1.3                            | ±14           |
|                      | D            |                   | 100                 | 60.5 以上                            |               |
| 6102B <sub>1</sub> Q | A            | 10.4              | 1600                | 73.3±1.7                           | ±2.5          |
|                      | B            | 10.4              | 1000                | 68.0±2.7                           | ±4            |
|                      | C            | ≈7.7              | 300                 | 11.0±1.5                           | ±14           |
|                      | D            |                   | 100                 | 60.5 以上                            |               |
| 6102G                | A            | 10.1              | 1400                | 49.4±1.5                           | ±2.5          |
|                      | B            | 10.7              | 900                 | 48±2.0                             | ±4            |
|                      | C            | ≈7.7              | 300                 | 9.4±1.3                            | ±14           |
|                      | D            |                   | 100                 | 69.5 以上                            |               |
| 6102G <sub>1</sub>   | A            | 9.7               | 1100                | 46±1.2                             | ±2.5          |
|                      | B            | 10.0              | 800                 | 42.8±1.7                           | ±4            |
|                      | C            | ≈7.7              | 300                 | 9.4±1.3                            | ±14           |
|                      | D            |                   | 100                 | 65 <sub>0</sub> <sup>+10</sup>     |               |
| 6102BG               | A            | 10                | 1250                | 56±1.5                             | ±2.5          |
|                      | B            | 11                | 830                 | 57±2.2                             | ±4            |
|                      | C            | ≈7.7              | 300                 | 9.4±1.3                            | ±14           |
|                      | D            |                   | 100                 | 69.5 <sub>0</sub> <sup>+10</sup>   |               |

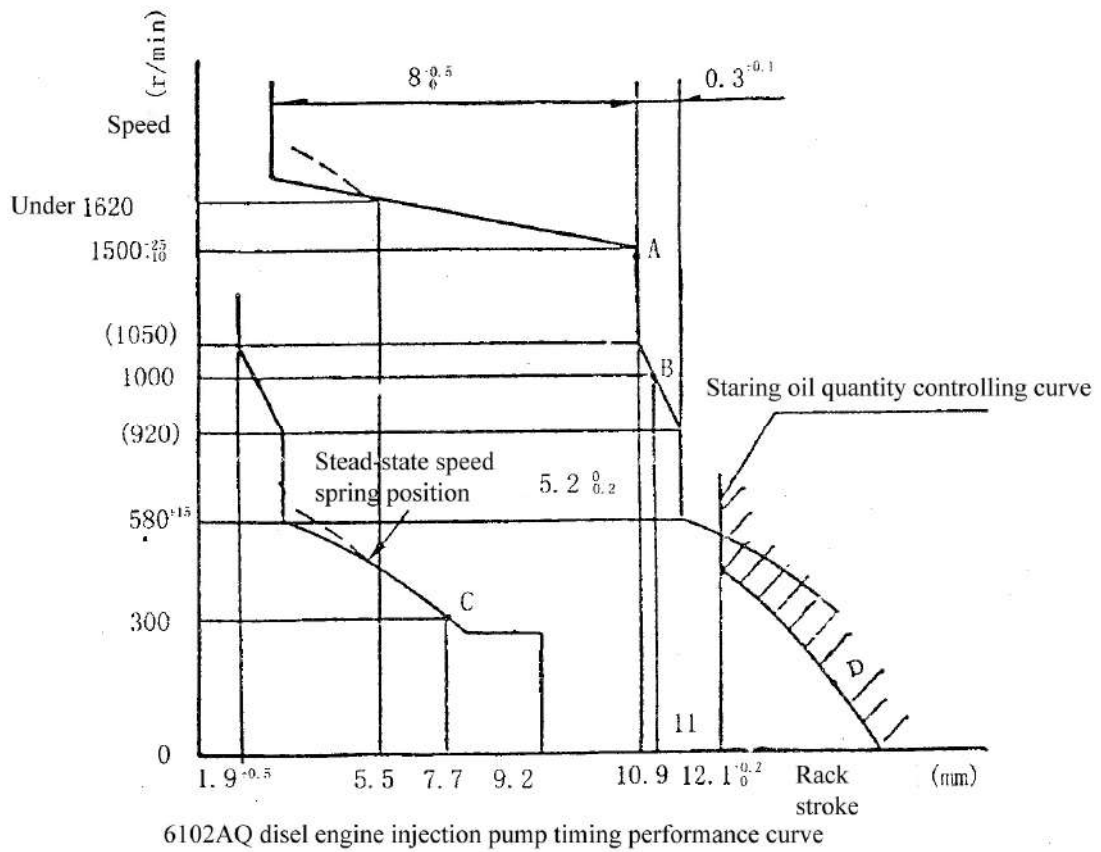
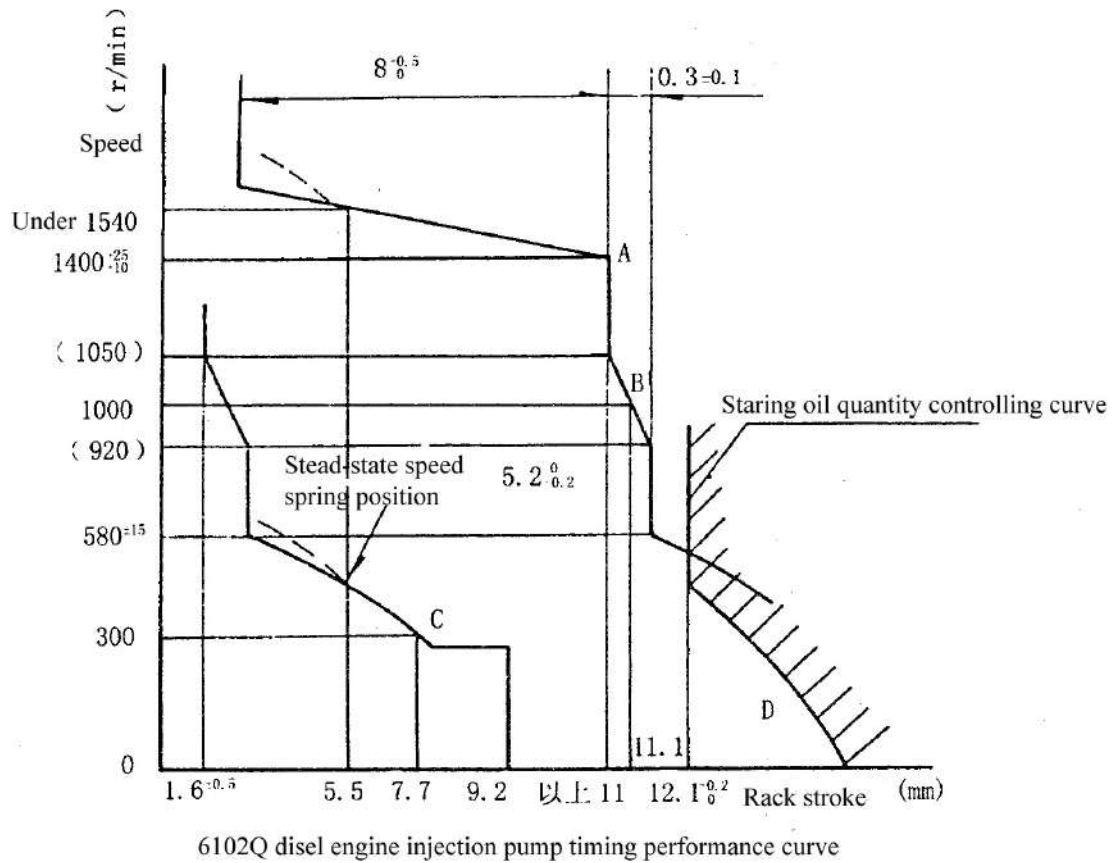

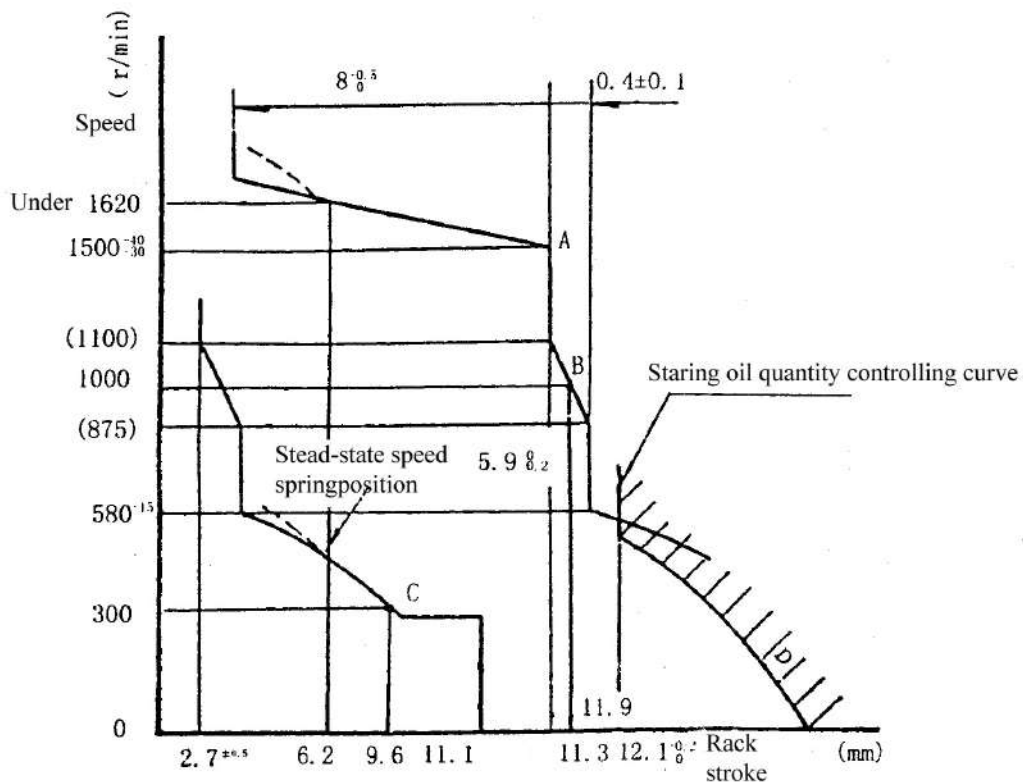

6102BQ diesel engine injection pump timing performance curve

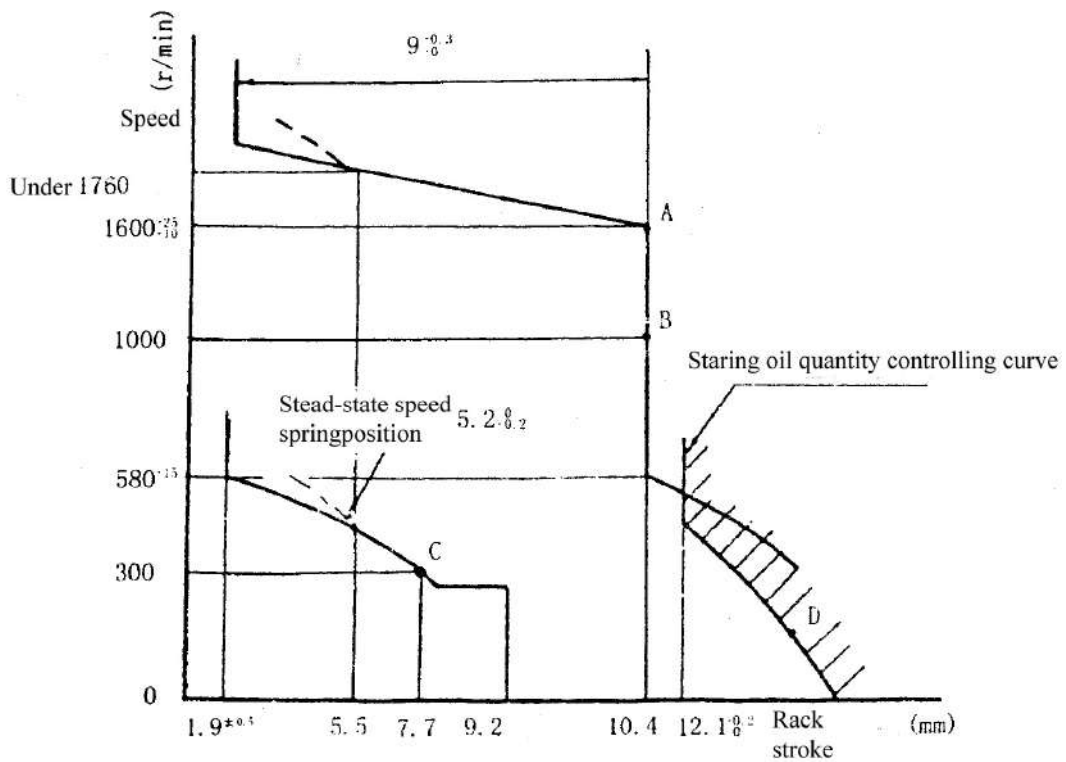

6102B1Q diesel engine injection pump timing performance curve

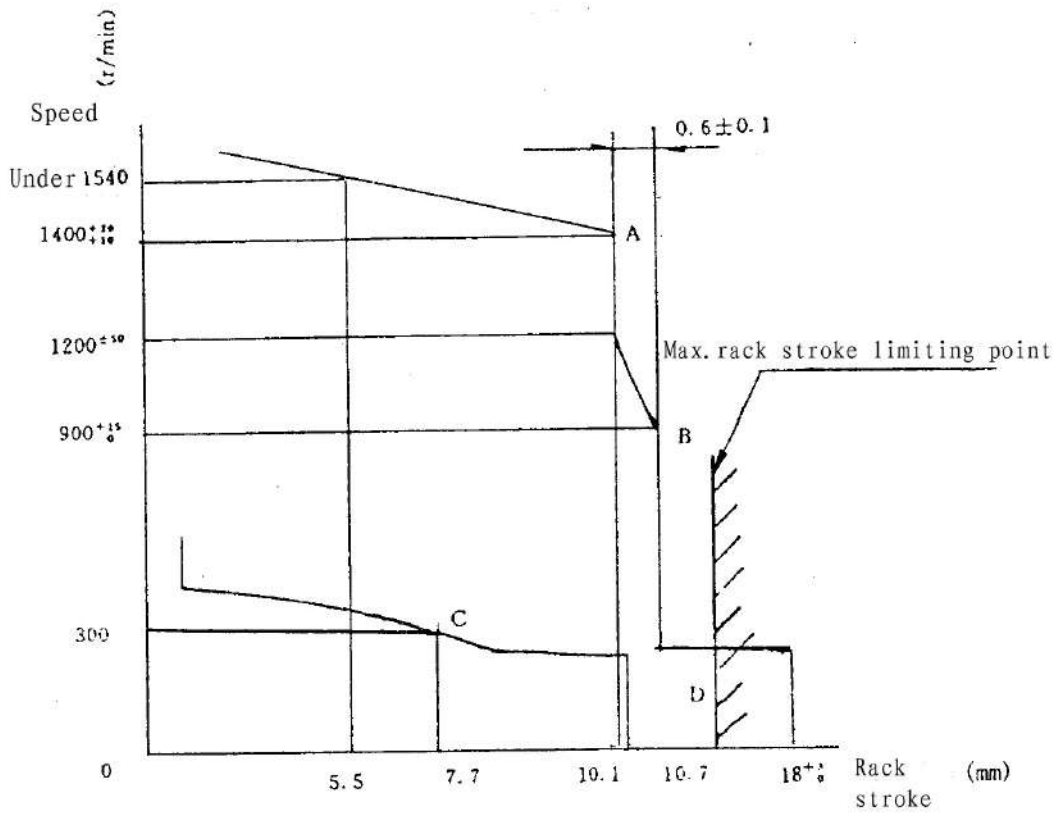

6102G diesel engine injection pump timing performance curve

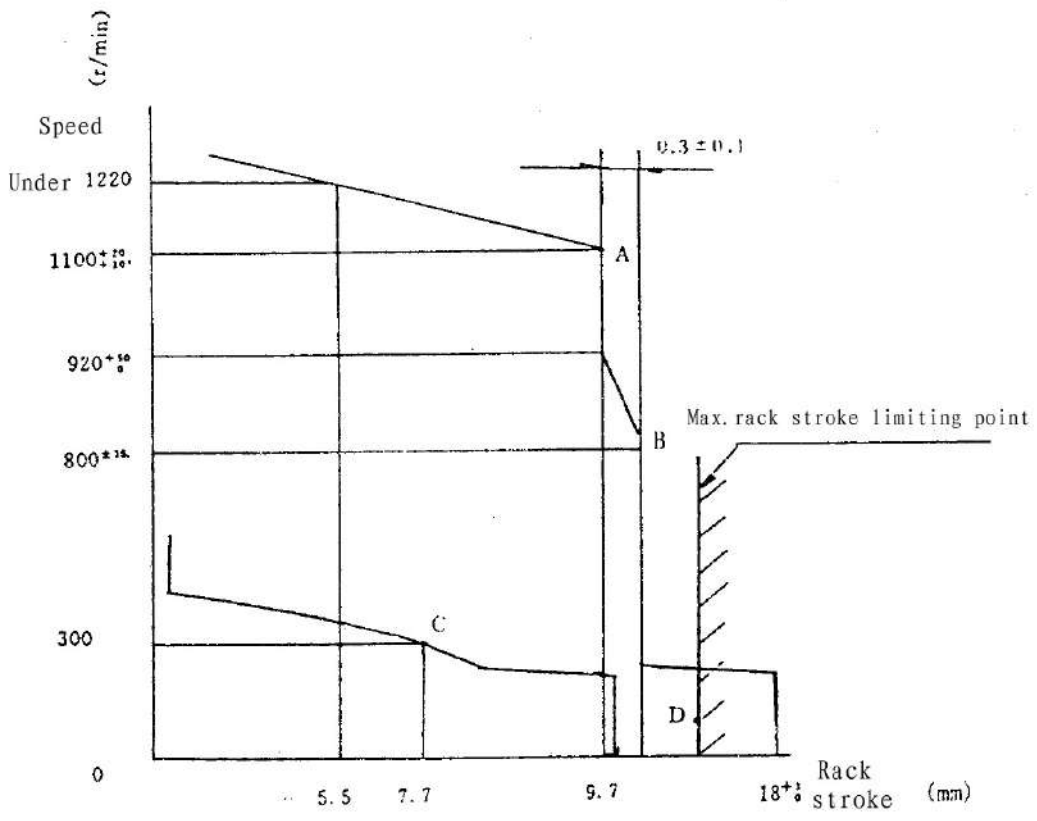

6102G1 diesel engine injection pump timing performance curve

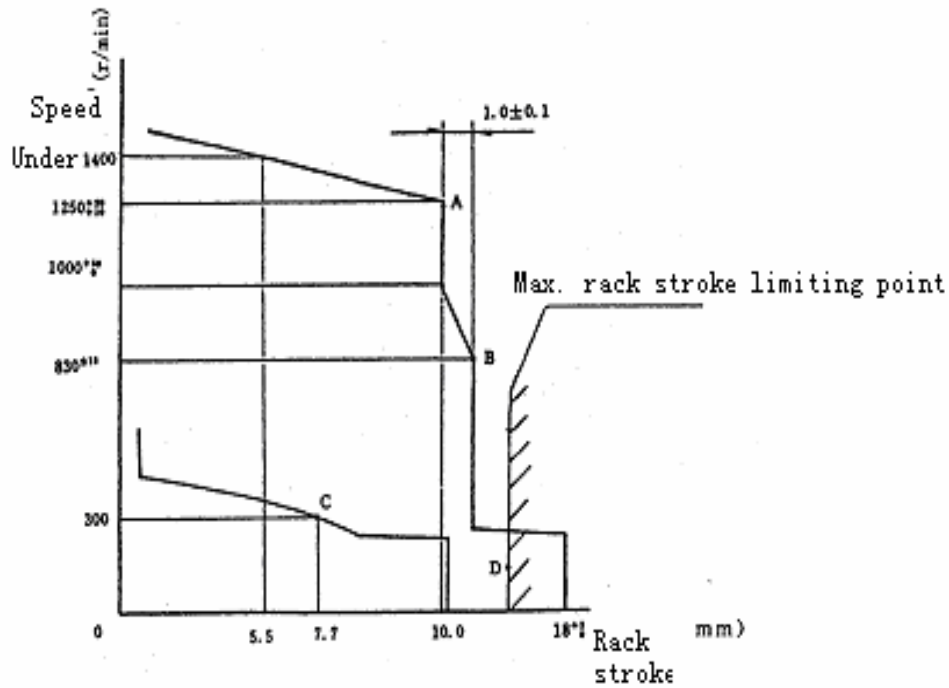

6102BG diesel engine injection pump timing performance curve

4102 injection oil quantity adjustable data table

| Engine type | Adjust point | Rack stroke mm | Pump speed r/min | Average supplying oil mL/1000St | Uneven value % |
|-------------|--------------|----------------|------------------|---------------------------------|----------------|
| 4102BQ      | B            | 10.2           | 1600             | 81.5±1.4                        | ≤±2.5          |
|             | A            | 10.2           | 1100             | 75.0±3.0                        | ≤±4            |
|             | C            | 8.5            | 300              | 12.0±1.7                        | ≤±14           |
|             | D            |                | 100              | Above 80                        |                |
| 4102BG      | A            | 9.3            | 1150             | 53.0±1.3                        | ≤±2.5          |
|             | B            | 11.4           | 800              | 56.3±2.3                        | ≤±4            |
|             | C            | 7.8            | 300              | 8.8±1.3                         | ≤±14           |
|             | D            |                | 100              | Above 65                        |                |
| 4102Q       | A            | 10.2           | 1100             | 51.0±2.0                        | ≤±4.0          |
|             | B            | 10.1           | 1750             | 49.2±1.3                        | ≤±2.5          |
|             | C            | 10.3           | 700              | 40.0±1.6                        |                |
|             | D            | 11.0           | 500              | 42.1±2                          |                |
|             | H            | 9.5            | 300              | 9.5±1.5                         | ≤±14           |
|             | I            |                | 100              | 73±8                            |                |



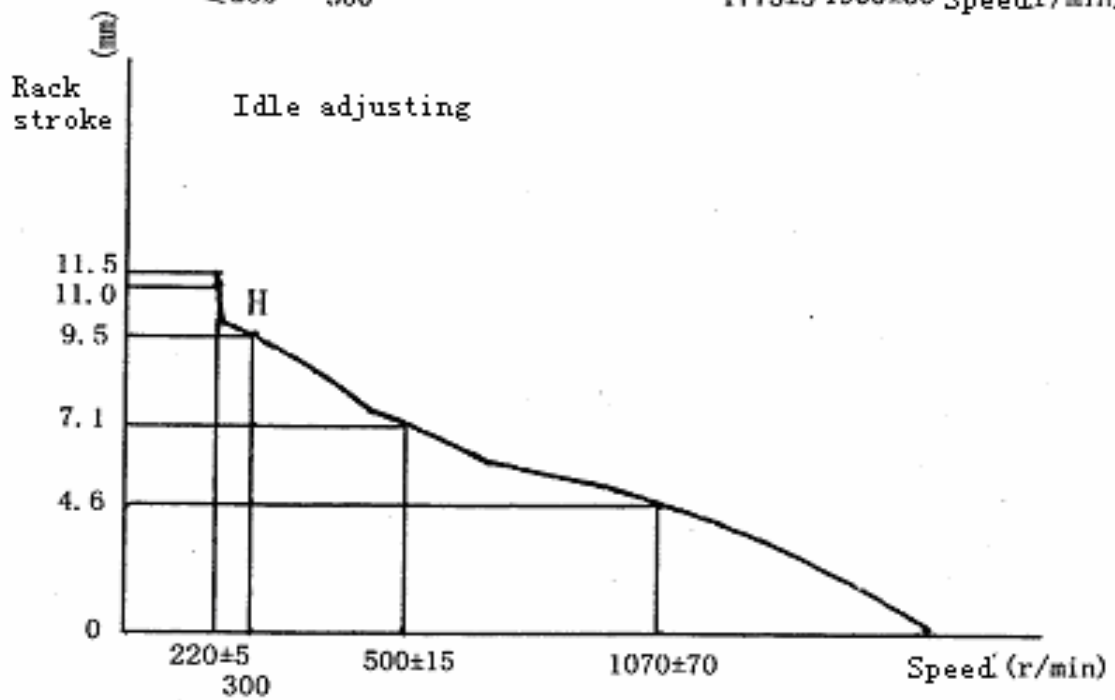
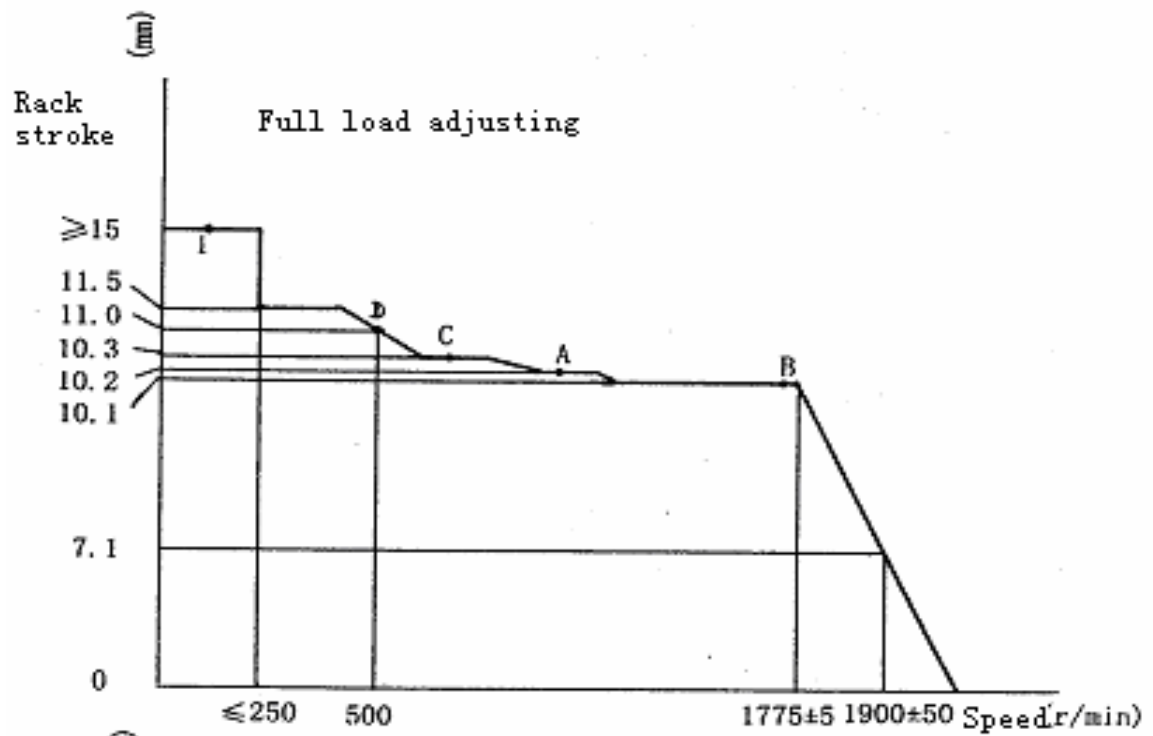

**4102Q diesel engine injection pump timing characteristic curve**

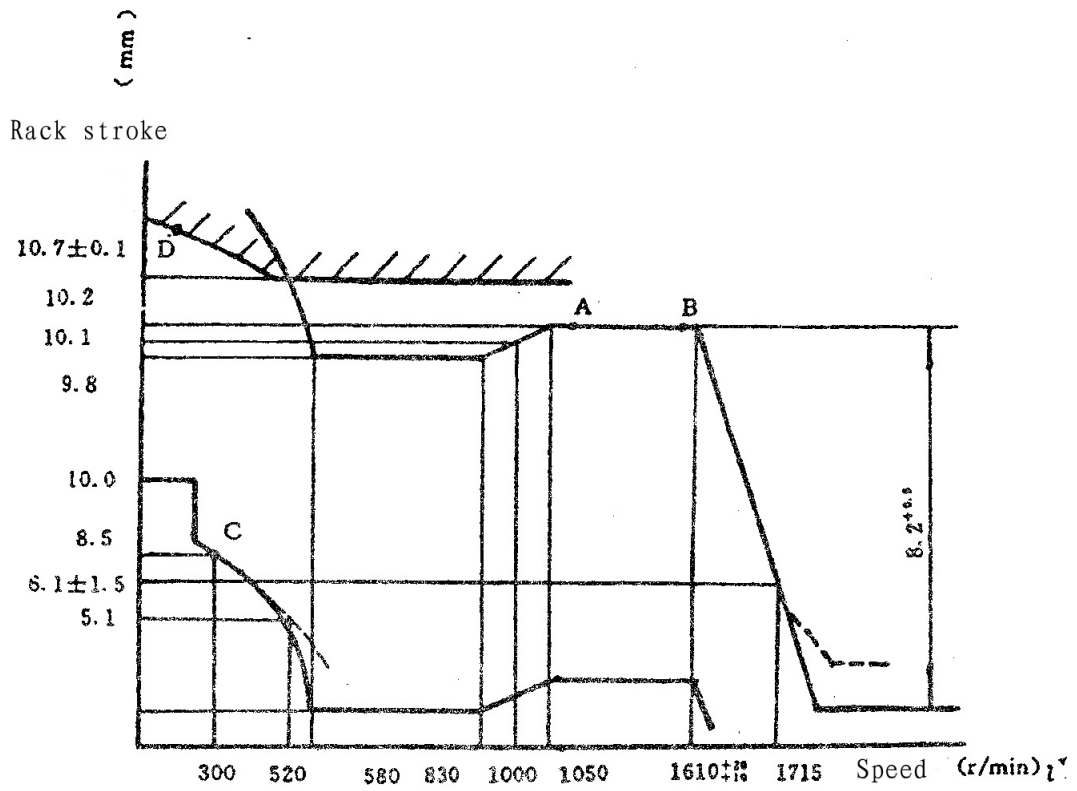

**4102BQ diesel engine injection pump timing characteristic curve**

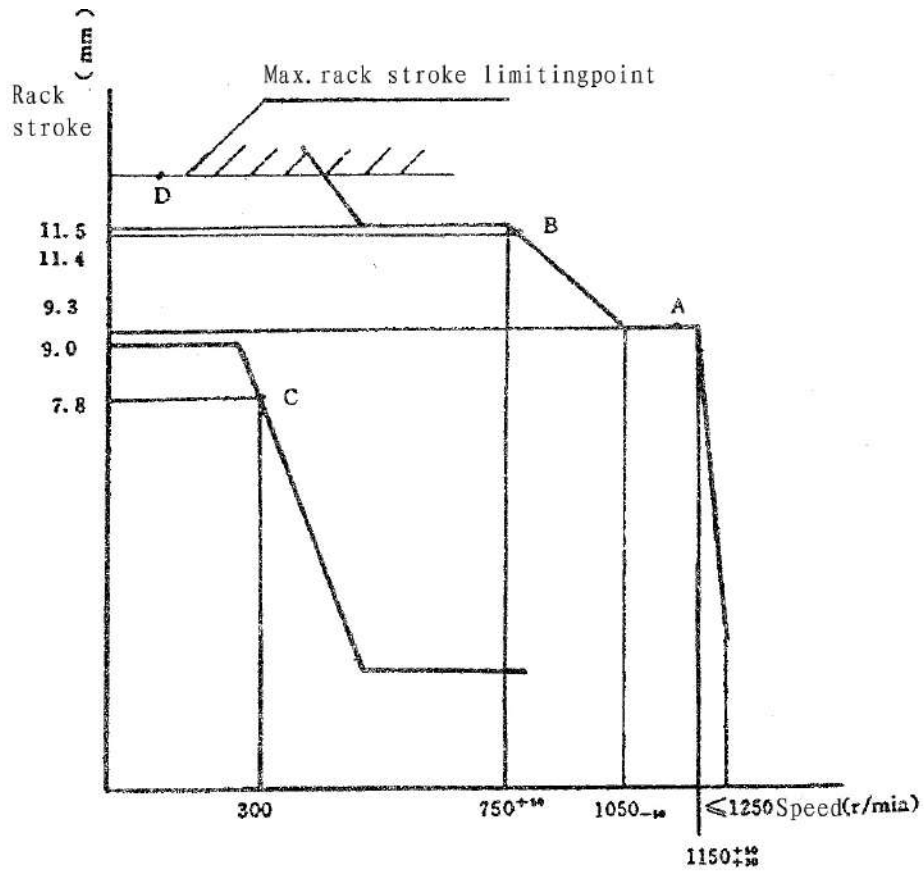

**4102BG diesel engine injection pump timing characteristic curve**

**CY4105Q diesel engine injection oil quantity adjustable data table**

| Engine type | Adjust point | Rack stroke mm | Pump speed r/min | Average supplying oil mL/1000St | Uneven Value % |
|-------------|--------------|----------------|------------------|---------------------------------|----------------|
| 4105Q       | A            | $10.4^{+0.5}$  | 1500             | $36 \pm 0.5$                    | $\leq \pm 2.5$ |
|             | B            | 10.4           | 1000             | $31.5 \pm 0.9$                  | $\leq \pm 4$   |
|             | C            | 7.8            | 300              | $4.1 \pm 0.6$                   | $\leq \pm 15$  |
|             | D            | (starting)     | 100              | 32-35                           |                |

**High-speed cutting off oil speed  $1660 \pm 20$ r/min, idler cutting off oil speed  $500 \pm 20$ r/min**

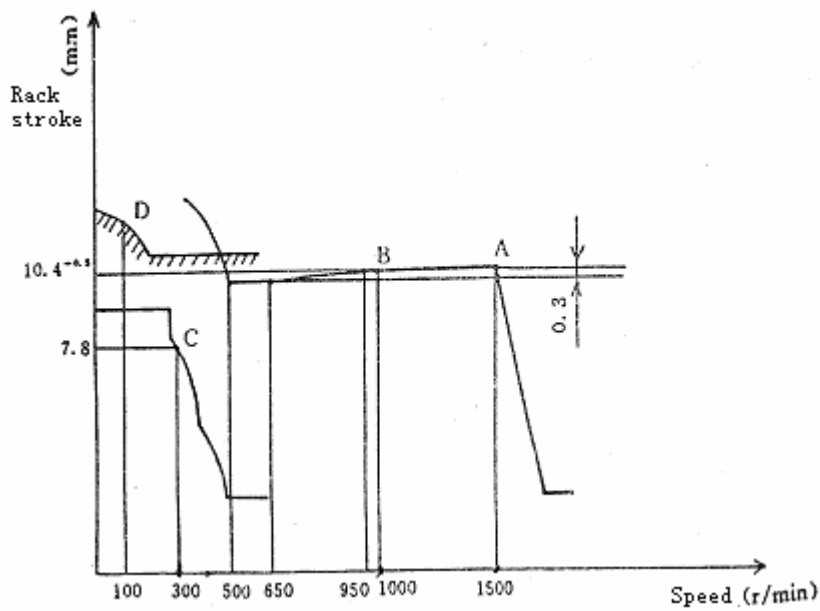

**CY4105 diesel engine injection pump timing characteristic curve**

CY6105 engine injection oil quantity adjustable standard

Plunger diameter  $\phi 9.5$  mm

| Rack position (mm)   | Pump speed (r/min) | Average supplying oil (mL/1000St) | Uneven value (%) |
|----------------------|--------------------|-----------------------------------|------------------|
| 10.5 <sup>+0.5</sup> | 1500               | 67.5 $\pm$ 1.5                    | $\pm 2.5$        |
| 10.7                 | 1000               | 65 $\pm$                          | $\pm 4.0$        |
| 9.0                  | 300                | 9.4 $\pm$ 1.3                     | $\pm 15$         |
| Starting             | 100                | 65-75                             |                  |

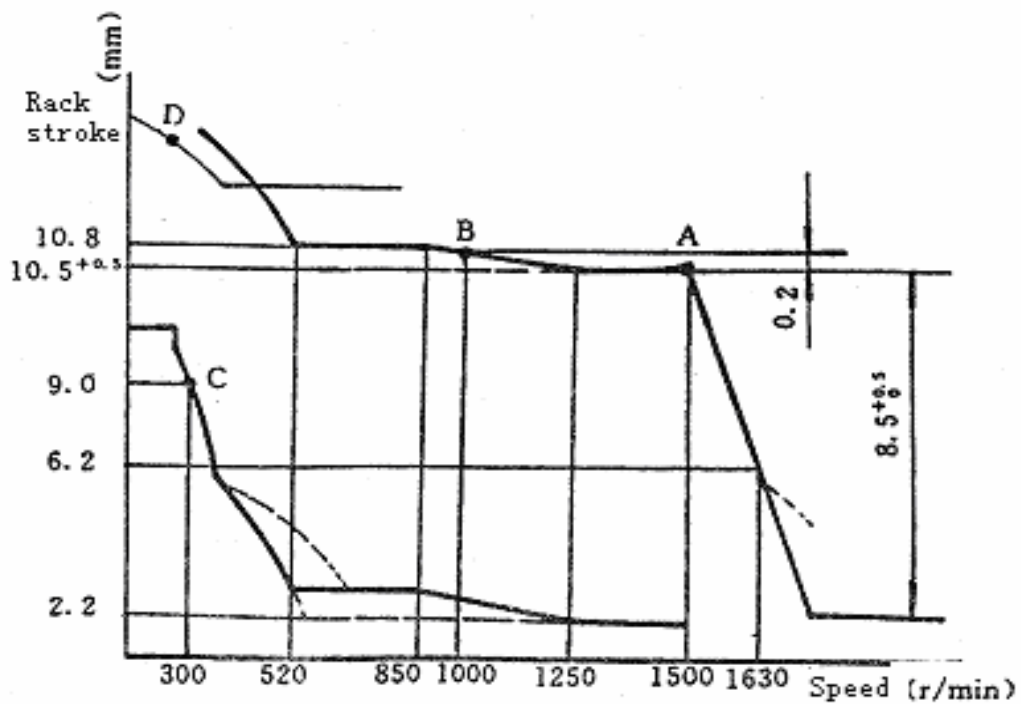

**CY6105 diesel engine injection pump governor timing characteristic curve**

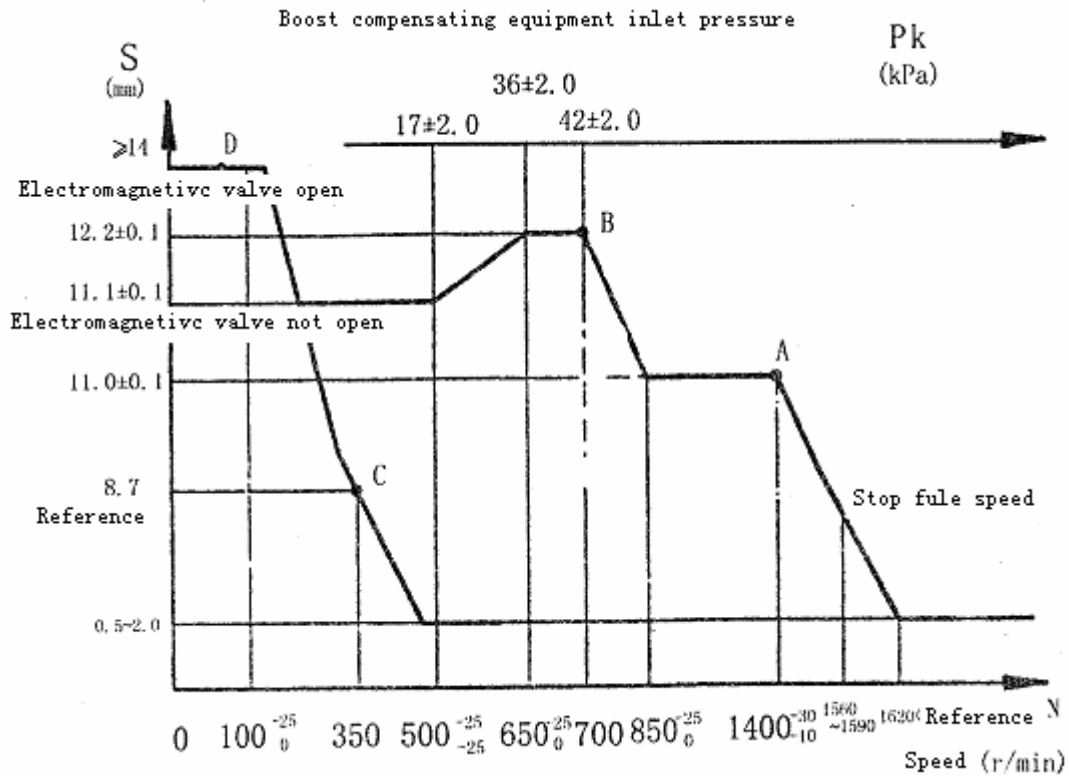

CY6102BZQ diesel engine common turbo-charger

Injection pump governing characteristic curve sheet  
and injection oil quantity adjustable data table

| Adjusting item                                |          | Injection pump r/min | Inlet pressure kPa | Rack position mm | Average supplying oil quantity ml/400St | Uneven value % |
|---|----------|----------------------|--------------------|------------------|---|----------------|
| Rated power point (A)                         |          | 1400                 | $(75 \pm 5)$       | $(11.0)$         | $36.5 \pm 1.0$                          | $\pm 3$        |
| Max. torque point (B)                         |          | 900                  | $(45 \pm 5)$       | 11.0             | $35.0 \pm 1.5$                          | $\pm 5$        |
| Booster compensating equipment function point | Starting | $850_{-0}^{+30}$     | $36 \pm 3.0$       | $(11.0)$         |   |                |
|   | End      | $700 \pm 30$         | $26 \pm 3.0$       | 10.65            | $4.8 \pm 1.6$                           | $\pm 18$       |
| Idler point (C)                               |          | 350                  |                    | $\approx 8.7$    |   |                |
| Starting point (D)                            |          | $850_{-0}^{+25}$     |                    | $\geq 14$        | 36-56                                   |                |
| Governor function                             | Starting | 1430-1455            |                    |                  |   |                |
|   | Stopping | <1600                |                    |                  |   |                |

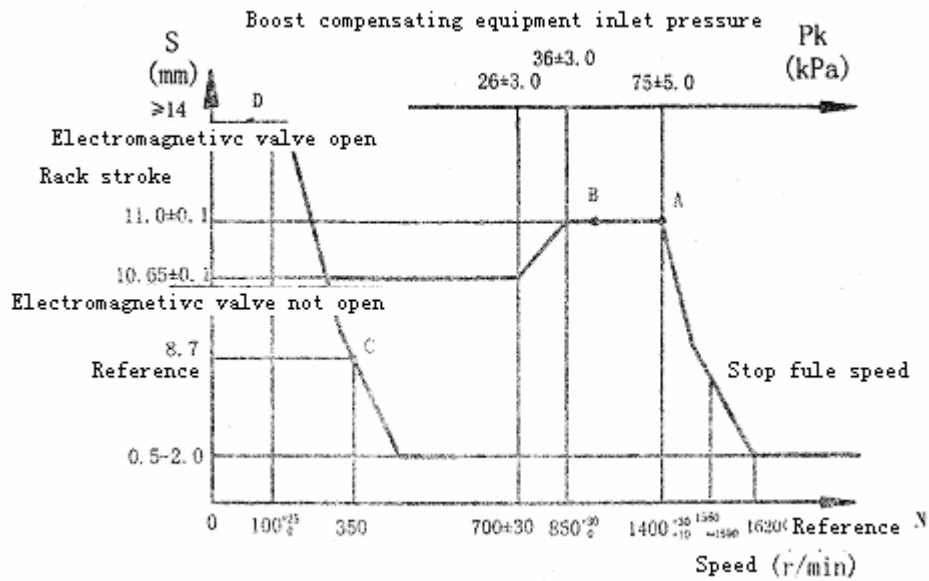

CY6102BZQ DIESEL ENGINE WITH EXHAUST RELIEF VALVE TURBO-CHARGE  
Injection pump governing characteristic curve sheet  
and injection oil quantity adjustable data table

| Adjusting item                                |          | Injection pump r/min | Inlet pressure kPa | Rack position mm | Average supplying oil quantity ml/400St | Uneven value % |
|---|----------|----------------------|--------------------|------------------|---|----------------|
| Rated power point (A)                         |          | 1400                 | (75 $\pm$ 5)       | (11.0)           | 36.5 $\pm$ 1.0                          | $\pm$ 3        |
| Max. torque point (B)                         |          | 700                  | (42 $\pm$ 2)       | 11.0             | 37.0 $\pm$ 1.5                          | $\pm$ 5        |
| Booster compensating equipment function point | Starting | 650 $^{+30}$         | 36 $\pm$ 2.0       | (12.2)           |   |                |
|   | End      | 500 $\pm$ 25         | 17 $\pm$ 2.0       | 4.8              |   |                |
| Idler point (C)                               |          | 350                  |                    | $\approx$ 8.7    | 37.0 $\pm$ 1.6                          | $\pm$ 18       |
| Starting point (D)                            |          | 100 $^{+25}$         |                    | $\geq$ 14        | 36-56                                   |                |
| Governor function                             | Starting | 1435-1460            |                    |                  |   |                |
|   | Stopping | 1560-1590            |                    |                  |   |                |

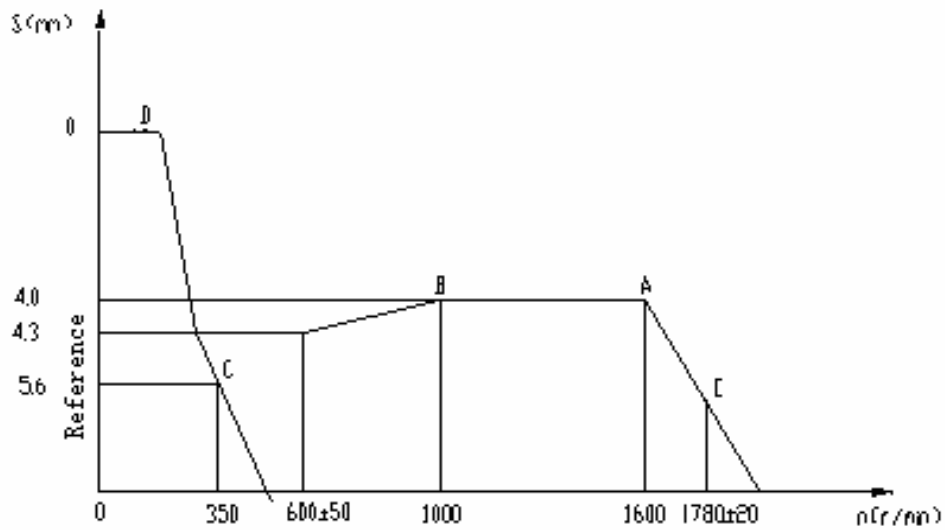

CY4100Q diesel engine injection pump and governor timing  
characteristic curve

CY4100Q diesel engine injection oil quantity adjustable data table

| Adjusting item                                |          | Injection pump r/min | Pinion position mm | Average supplying oil quantity ml/400St | Uneven value % |
|---|----------|----------------------|--------------------|---|----------------|
| Rated power point (A)                         |          | 1600                 | 4.0                | $30 \pm 0.8$                            | $\pm 4$        |
| Max. torque point (B)                         |          | 1000                 | 4.0                | $25.5 \pm 0.7$                          | $\pm 3$        |
| Booster compensating equipment function point | Starting | $975 \pm 25$         | (4.0)              |   |                |
|   | End      | $600 \pm 50$         | 4.3                | $18.5 \pm 0.10$                         | $\pm 7$        |
| Idler point (C)                               |          | 350                  | 5.6 (reference)    | $5.0 \pm 1.0$                           | $\pm 15$       |
| Starting point (D)                            |          | 125                  | 0                  | $\geq 3.8$                              |                |
| Governor function                             | Starting | 1630-1650            |                    |   |                |
|   | Stopping | $\leq 1810$          |                    |   |                |



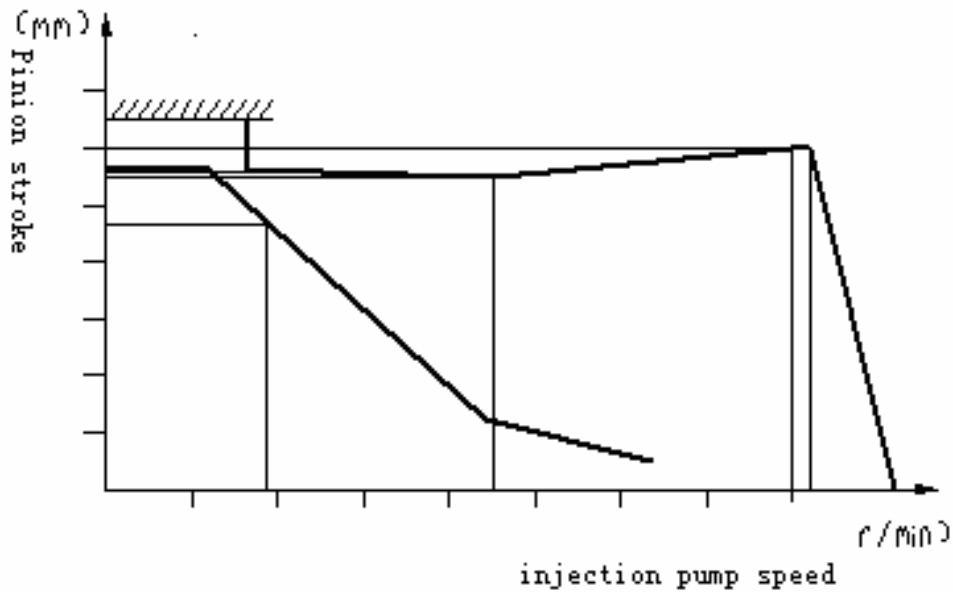

CY4100ZLQ engine injection pump governor characteristic curve

CY4100ZLQ engine injection oil quantity adjustable data table

| Pinion Stroke And Oil Adjusting | Adjusting value                          | Speed (r/min) | Pinion stroke (mm) | Average supplying oil quantity ml/300st | Uneven value % | Pressure value |
|---------------------------------|--|---------------|--------------------|---|----------------|----------------|
|                                 | Special behavior                         |               |                    |   |                |                |
| Special behavior                |  |               | 12±0.1             | 24.6±1.0                                | ≅ ±4           |                |
| Correct behavior                |  |               | 11.1±0.1           | 17.0 ± 0.5                              | ≅ ±3           |                |
| Low-speed behavior              |  |               | 11.3~11.6          | 13~15                                   |                |                |
| Idler behavior                  |  |               | (9.6)              | 4.0 ± 0.7                               | ≅ ±18          |                |
| Starting behavior               |  |               |                    |   |                |                |
| Specific point Control-ling     | Function speed for high speed (r/min)    |               |                    | 1650 ±10                                |                |                |
|                                 | Cut off oil speed for high speed (r/min) |               |                    | ≅ 1880                                  |                |                |
|                                 | Idler cut off speed (r/min)              |               |                    | ≅ 580                                   |                |                |
|                                 | Detaching speed (r/min)                  |               |                    | ≅ 330                                   |                |                |

CY4102BZLQ-A diesel engine injection pump (PW) injection oil

quantity adjusting data table

| Adjusting item           | Injection pump r/min | Inlet pressure kPa | Pinion position mm | Average supplying oil quantity cm <sup>3</sup> /200 times | Uneven value % |
|--------------------------|----------------------|--------------------|--------------------|---|----------------|
| Rated power point (B)    | 1400                 | 100                | 11.5±0.1           | 21±1.2  | ±4             |
| Max. torque point (A)    | 800                  | 100                | 10.7±0.1           | 18±1  | ±2.5           |
| Min. static behavior (C) | 500                  | 100                | 10±0.1             | 15±1.5  | ±5             |
| Idler point (H)          | 350                  |                    | 7.2(reference)     | 6±0.9   | ±15            |
| Starting point (I)       | 150                  |                    | /                  | >24   | /              |

CY4102BZLQ diesel engine injection pump injection oil quantity

adjusting data table

| Adjusting item           | Injection pump r/min | Inlet pressure kPa | Pinion position mm | Average supplying oil quantity cm <sup>3</sup> /500 times | Uneven value % |
|--------------------------|----------------------|--------------------|--------------------|---|----------------|
| Rated power point (B)    | 1400                 | Above 100 (750)    | 11.5               | 65  | ±4             |
| Max. torque point (A)    | 800                  | Above 100 (750)    | 10.2               | 52  | ±3             |
| Min. static behavior (C) | 500                  | Above 100 (750)    | 8.7                | 25  | ±10            |
| Idler point (H)          | 350                  |                    | 7.2                | 8   | ±15            |
| Starting point (I)       | 150                  | 0                  | 13.0               | >70   | /              |

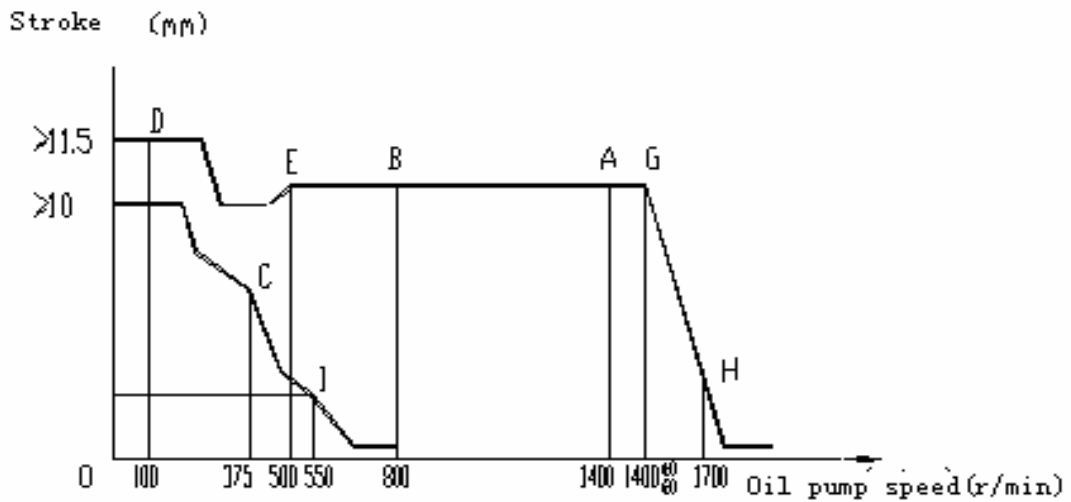

CY4102EZLQ engine injection pump governing  
characteristic curve (PWS injection pump)

CY4102EZLQ diesel engine injection oil quantity adjusting  
data table (PWS injection pump)

| Adjusting item                                |              | Injection pump r/min | Inlet pressure (MPa) | Pinion stroke mm | Average supplying oil quantity ml/200times | Uneven value % |
|---|--------------|----------------------|----------------------|------------------|--|----------------|
| Rated power point (A)                         |              | 1400                 | 0.1                  | (13±0.1)         | 24.8±0.8                                   | ±4.5           |
| Max. torque point (B)                         |              | 800                  | 0.1                  | (11.1±0.1)       | 18.9±0.8                                   | ±3.5           |
| Booster compensating equipment function point |              | 500                  | 0.02                 | (10.1~10.5)      | 31±1.5                                     |                |
|   |              |                      | 0.01                 | (9~9.8)          |  |                |
|   |              |                      | 0                    | (8.5~8.9)        |  |                |
| Idler point (C)                               |              | 370                  | 0                    | 6.6 ± 0.2        | 2±0.5                                      | ±18            |
| Starting point (D)                            |              | 150                  | 0                    | ≥11.5            |  |                |
| Governor function                             | Starting (G) | 1420~1460            | 0.1                  |                  | ≤3   |                |
|   | Stopping (H) | 1700                 | 0.1                  |                  |  |                |

CY4100EZLQ diesel engine injection oil quantity adjusting  
 data table (VE injection pump)

| Adjusting item | Inlet pressure<br>(mmhg) | Average supplying oil<br>quantity l/400times | High-speed<br>hand shank |
|----------------|--------------------------|--|--------------------------|
| 1750           | 670                      | $36 \pm 1.4$                                 | Full                     |
| 1350           | 650                      | (30)   | Full                     |
| 1000           | 480                      | $31 \pm 1.5$                                 | Full                     |
| 700            | 205                      | (22)   | Full                     |
| 500            | 95                       | $17 \pm 1.5$                                 | Full                     |
| 375            | 0                        | $5.75 \pm 0.9$                               | idler                    |

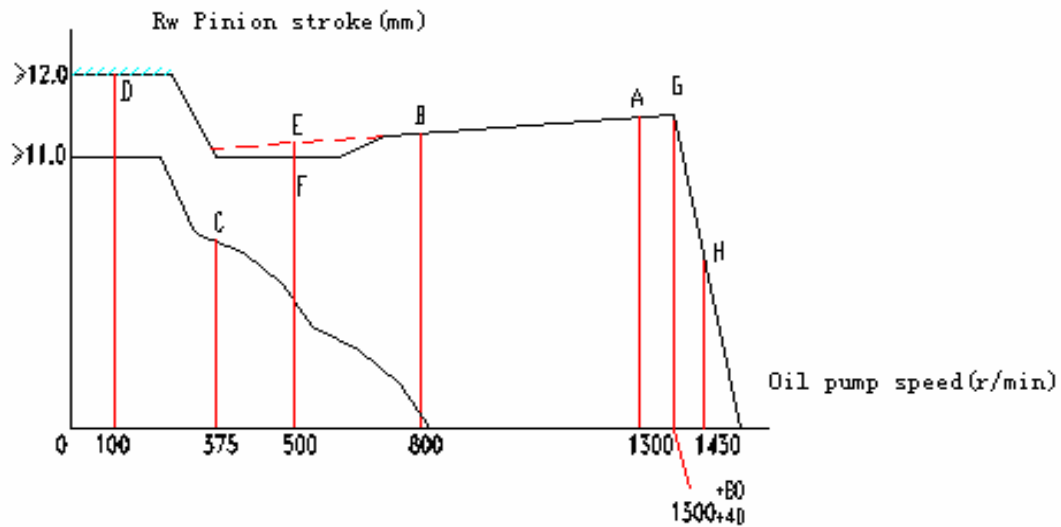

## CY6102BZLQ-W diesel engine injection pump governing characteristic curve

### CY6102BZLQ-W diesel engine injection oil quantity adjusting data table

| Adjusting item   |                 | Injection pump<br>r/min | Inlet pressure<br>(MPa) | Pinion stroke<br>mm | Average supplying<br>oil quantity<br>ml/1000times | Uneven<br>value % |
|--|-----------------|-------------------------|-------------------------|---------------------|---|-------------------|
| Rated power point (A)                                      |                 | 1300                    | 100                     | (11.5-11.6)         | 113±3.0   | ±<br>4.5          |
| Max. torque point (B)                                      |                 | 800                     | 100                     | (11.2-11.4)         | 105±3.0   | ±<br>3.5          |
| Booster compensating<br>equipment function<br>point<br>(E) |                 | 500                     | 100                     | (10.7-10.7)         |   |                   |
| Idler point (C)  |                 | 375                     | 0                       | (7.0 - 8.0)         | 14.5±2.0  | ±18               |
| Starting point (D)   |                 | 100                     | 0                       | ≥12.0               |   |                   |
| Governor<br>function                                       | Starting<br>(G) | 1340~1380               | 0.1                     | (11.1-11.4)         |   |                   |
|  | Stopping(H)     | 1430                    | 0.1                     | (8.5-9.0)           | 34.5±5.0  |                   |

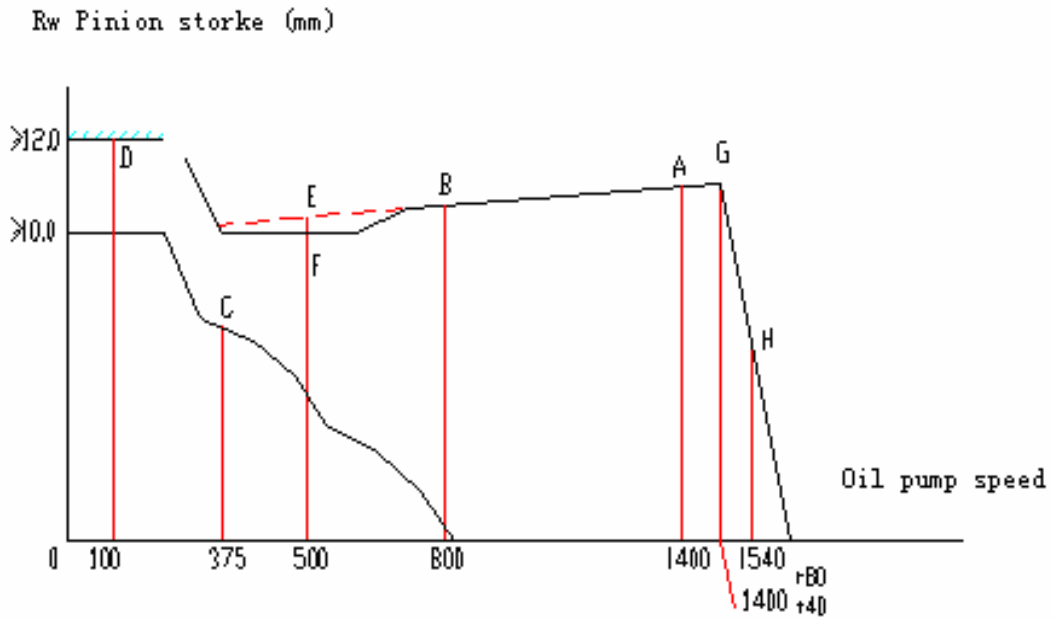

CY6102BZLQ- A、-B、-C diesel engine injection oil quantity  
adjusting data table

| Adjusting item                                    |              | Injection pump r/min | Inlet pressure (MPa) | Pinion troke mm | Average supplying oil quantity ml/1000times | Uneven value % |
|---|--------------|----------------------|----------------------|-----------------|---|----------------|
| Rated power point (A)                             |              | 1400                 | 100                  | (01.5-10.6)     | $90 \pm 2.5$                                | $\pm 4.5$      |
| Max. torque point (B)                             |              | 800                  | 100                  | (10.2-10.5)     | $87 \pm 2.5$                                | $\pm 3.5$      |
| Booster compensating equipment function point (E) |              | 500                  | 50                   | (10.1-10.5)     |   |                |
|   |              |                      | 23                   | (10-10.4)       |   |                |
|   |              |                      | 20                   | (9.8-10.2)      |   |                |
|   |              |                      | 50                   | (9.2-9.6)       |   |                |
| Idler point (C)                                   |              | 375                  | 0                    | (7.0 - 8.0)     | $13 \pm 2.0$                                | $\pm 18$       |
| Starting point (D)                                |              | 100                  | 0                    | $\geq 12.0$     |   |                |
| Governor function                                 | Starting (G) | 1440-1480            | 100                  |                 |   |                |
|   | Stopping (H) | 1540                 | 100                  |                 | $14.5 \pm 4.0$                              |                |

## **Adjusting of supplying oil quantity when diesel engine operated on the plateau**

**On the plateau the air is rare, and the pressure is low, so the inlet air reduces for diesel engine. In order to ensure fuel burned fully, don't make consumption of diesel engine increase so much, black smoke, and the engine overheat and ensure the life, the supplying oil quantity of injection pump must reduce than standard atmosphere status, so must adjust supplying oil quantity of injection pump.**

**The proportion between rated oil quantity and standard oil at the all kinds of altitude height (non turbo-charge):**

| <b>Altitude height (m)</b> | <b>Variety rate (%)</b> |
|----------------------------|-------------------------|
| <b>0~1000</b>              | <b>100</b>              |
| <b>&gt;1000~2000</b>       | <b>87</b>               |
| <b>&gt;2000~3000</b>       | <b>74</b>               |
| <b>&gt;3000~4000</b>       | <b>60</b>               |

The chapter 4 Operation & maintenance of diesel engine

Choice of fuel, engine oil and cooling liquid

Fuel divided into light fuel and heavy fuel. In general vehicle diesel engine used light fuel. Producing of fuel must

comply the national standards, national standard GB252-2000 stipulated light fuel spec. of national producing.

According to the mass, national producing light fuel divided into three grades: high mass grade, the first grade and acceptable product, their different is the content of sulphur and ash. We should try our best to choose high mass grade or the first grade light fuel, in case the content of sulphur is higher, and will make engine corrupt heavily.

According to the solidifying point, every grades light fuel is divided into six trademarks: 10# light fuel adapts to use for high-speed vehicle diesel engine with pre-heating equipment. 0# light fuel adapts to use above 4°C at the lowest temperature. -10# light fuel adapts to use above - 5°C at the lowest temperature. 20# light fuel adapts to use above - 5°C -- -14°C at the lowest temperature. 35# light fuel adapts to use above 14°C --- 29°C at the lowest temperature. 50# light fuel adapts to use above 29 °C --- -44 °C at the lowest temperature. When the customers used it, the type of fuel must be chosen in light od seasons and climate.

Fuel must be deposited and filtered with silk cloth and so on ensure it cleaning. And the instrument of filling must be clean, in case shorten the life of fuel filter.



## Engine oil

According to internal engine type, oil is divided into a lot of varies, diesel engine only used fuel. Oil is divided into two varies according to the viscosity and mass. According to the quality, it is divided into CA、CB、CC、CD、CE、CF and so on. If the emission met EURO II and above standard engine in our Company, it should use CF-4 grade turbo-charge oil, the other engine should choose CD grade engine oil. But according to the moving viscosity and adopting to the temperature, every grade engine oil is divided into following varies:

| Trademarks of engine oil | Moving viscosity mm <sup>2</sup> /s at 100°C | Temperature°C at max. moving viscosity | Max. moving viscosity Pa. s |
|--------------------------|--|--|-----------------------------|
| 5W/30                    | 9.3~12.5                                     | -25                                    | 3.5                         |
| 10W<br>10W/30            | 5.6~7.4<br>9.3~12.5                          | -20                                    | 3.5                         |
| 15W/30<br>15W/40         | 9.3~12.5<br>12.5~16.3                        | -15                                    | 3.5                         |
| 20W/20<br>20W40          | 7.4~9.3<br>12.5~16.5                         | -10                                    | 4.5                         |
| 30                       | 9.3~12.5                                     | -                                      | -                           |
| 40                       | 12.5~16.3                                    | -                                      | -                           |

From the above table, we know oil chooses according to the lowest operating temperature, for example, in general, in

North the winter only choose 5W/30, 10W/30 and so on, but in South, in summer chose 30#, 40# and so on. Besides we consider the temperature is about same, but different engine is with different load. For example, 6102BZQ compared with 6102BQ, at the rated behavior, the pressure is bigger than the front that crankshaft journal endured, so when we choose oil, we should consider the factor, and choose bigger viscosity.

Note: Used oil, vehicle or diesel engine worked every one hundred thousand kilometers or for one month, must replace oil according to the stipulated oil trademark in manual.

The table is for the choice of 6102BZQ engine oil, the other engine see the manual.

| Oil trademark | Adopted to the temperature |
|---------------|----------------------------|
| 40            | Above +5℃                  |
| 30            | -5℃ ~ 30℃                  |
| 15W/40        | Above -10 ℃                |
| 10W/30        | -20 ℃~ -5℃                 |
| 5W/30         | Above-25℃                  |

Crease: Crease must be applied with grease gun timely.

## Cooling liquid:

Soft water is required because of configuration compactness and narrow water circuits in the engine block. Water from well, spring and city running water must be boiled or treated chemically. This is especially important for regions where water contains heavy Saline-alkalinity, or water circuits may deposit scale, and lead to corrosion or failure. The chemical methods of harden water softening is: In harden water filled conditioner, such as sodium bicarbonate, sodium hydroxide and so on, in general fill 0.5~1g sodium bicarbonate or 0.5 ~0.8g sodium hydroxide each one liter water.

In winter, the temperature will reduce under 0°C at the cold area, here the water will can ice. To the diesel engine without heat preservation measure and stopping operation, the water in the engine will ice, and After water iced, its volume will become expanding, and cylinder-block, cylinder-head, radiator and so on will be expanded crack, so must take the icing preservation measure. The methods: to give the vehicle heat preservation, such as, setting up the warm garage, when stopped operating, drain off cooling water in the diesel engine, add the antifreezer to reduce the freezing point of water.

The ideal method is: add antifreezer into cooling water to

brewage antifreeze liquid. In general antifreeze liquid includes alcohol---water, glycerin-water and glycol---water three kinds, their blending is different with water, and the icing point is also different with water. See the following table:

The blending proportion of antifreeze liquid

| Ice point (°C) | Alcohol-water (Alcohol mass %) | glycerin-water (Glycerin mass %) | glycol---water (Glycol mass %) |
|----------------|--------------------------------|----------------------------------|--------------------------------|
| -5             | 11.3                           | 21                               | -                              |
| -10            | 19.5                           | 32                               | 28.4                           |
| -15            | 26.0                           | 43                               | 32.3                           |
| -20            | 31.0                           | 51                               | 38.5                           |
| -25            | 35.1                           | 58                               | 45.3                           |
| -30            | 40.6                           | 64                               | 47.8                           |
| -40            | 55.1                           | 73                               | 54.7                           |
| -50            | 70.1                           | -                                | 59.9                           |

Because the antifreeze liquid will become expanding with temperature rising, when add into the cooling system, the adding volume is smaller 5%-6% than the total volume of cooling system.

Glycol---water antifreeze is with noxious, when use it, must pay attention not to enter the mouth. The boiling point

of glycol is 197.4 °C, so the water in the antifreeze liquid volatilize easily, after used for period of time must add water. But alcohol—the boiling point in the water antifreeze is low, and volatilize easily, after used for period of time must add proper alcohol.

Except the above three antifreeze, and also has permanence antifreeze liquid, such as ethane-glycol blended with water—glycol antifreeze liquid, because the antifreeze liquid make the boiling point rise high, don't volatilize easily, so it belongs to the permanence antifreeze liquid. The blending antifreeze liquid with 55% ethane and glycol and 45% water (according to the mass proportion) be used at the cold area -40°C.

At present, we have used the antifreeze and antirust with antifreeze and antirust function in vehicle diesel engine in our country. It is made of water - glycol antifreeze adding into many additives, it ensure not to freeze at temperature above -35 °C, and also can prevent radiator and water sleeve of diesel engine from rusting, and reduce scale, and increase the life of radiator and radiating performance of cooling system. In general the antifreeze liquid will continue to use for two years.

If it is not antifreeze and antirust that the diesel engine adopted cooling, you must clean the scale after the period of time. In general adopt the methods: The blending the cleaner fill into the cooling system to wash that add 750g caustic soda and 150g kerosene in 10L water. The washing process: the first the diesel engine regards the cleaner as cooling, then run 5-10min at medium-speed, after make cleaner heat, then stop it, make cleaner stop 10-12h in diesel engine, then start engine again to run 10-15min at medium-speed, and drain off cleaner, and then fill cleaning water again to run for the period of time at the medium-speed, then drain it off. If the scale is too much, may repeat the above process for 2-3 times.

## The normal operational rule

### Starting of diesel engine

Before the engine start, we must check if the different parts of diesel engine is normal or firmly connect, and check if oil, cooling water and fuel volume is suitable and leakage. In winter fill oil and water according to the usage technical maintenance of winter. Check if the electric system connects firmly and accumulator is fully charged. Check if running part is apart. The engine can't start until the above problems were

treated. The starting process: push the brake handle, and discharge air in fuel system with hand oil pump on injection pump, then tread the throttle treadle, then switch on power connection with key, and observing the electric meters if it operates normal, and then turn the key to the starting position to start the engine. If the 5S can't start, should cut off the starting circuit and wait for two minutes, then start it.

After start the engine, loose the key (it can return automatically), here the supplying oil volume is not too much, and ensure engine operate steadily. Check oil pressure and cooling water supplying, and run for 5-10min at low-medium, and after the water temperature rose, then you can increase loading gradually.

## Preheating equipment

In order to ensure engine starting smoothly at the low temperature and eliminate white smoke when starting, so many engine installed diesel engine preheating equipment, please carry out using, maintenance and repairing according to the following requirements.

Please judge using the engine if it is with preheating equipment diesel engine.

If it is with preheating equipment, please judge whether the preheating equipment is with controller or not.

1. The operation instruction of preheating equipment without controller

(1) The operation instruction of electrothermal plug

① The using voltage of electrothermal plug must be the same with accumulator (12V or 24V).

② When junction end is connecting line, the tighten torque of nut is  $\cong 7\text{N.m}$ .

③ The preheating time is more than 20 seconds and less than 60 seconds, if the heating time is too long, it will effect the operating life of electrothermal plug assembly.

④ If the head of the electrothermal plug damaged, should replace electrothermal plug assembly, or electrothermal plug will shorten circuit easily.

⑤ Prevent current-conducting plate from contacting nearby objects, and in case shorten circuit to burn the electric system.



(2) Installing drawing for the diesel engine preheating equipment

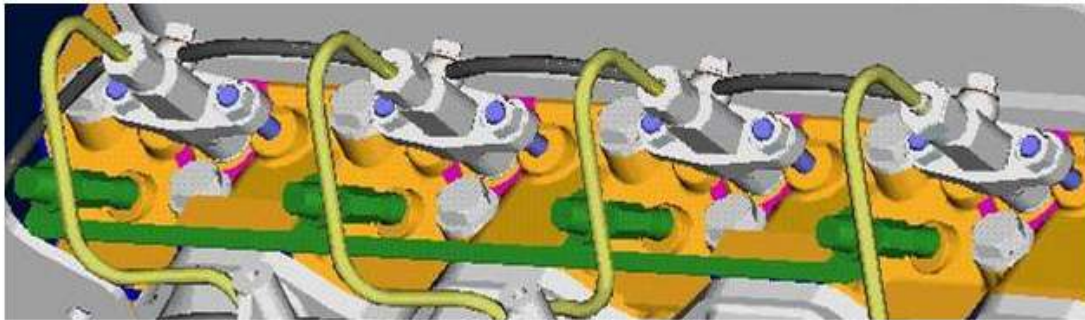

Elelectrothermal plug

Current-conducting plate

(3) The working principle of the diesel engine preheating equipment

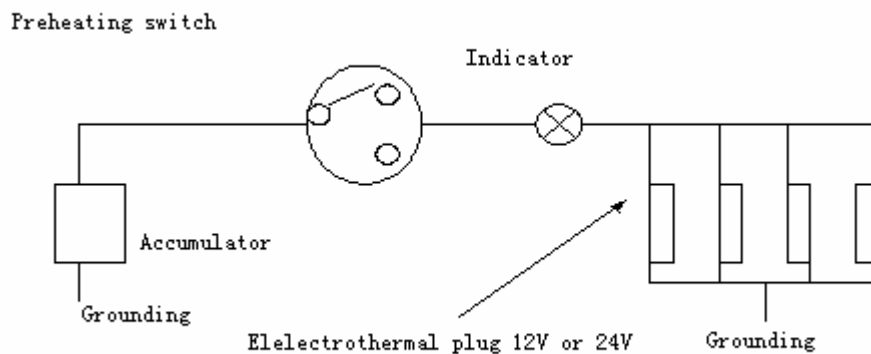

2. The operating instruction of the diesel engine preheating equipment with controller

(1) Please connect line correctly according to junction drawing strictly, especially pay attention to the correct

connecting for the positive pole of electrical source, or electric controlling equipment will not work normally, and may damage.

(2) When start engine, if turn the key switch to the working position, the preheating light is bright, it showed the temperature of cooling is lower than setting the value  $15 \pm 1^{\circ}\text{C}$  of controller , the system will automate to preheat. When the preheating indicating light blinks, then can start engine. If in  $20 \pm 2$  second for the beginning of the preheating indicating light blinking, Can' t still start engine, the electric equipment will automate to cut off electric circuit, and the preheating indicating light stop blinking. If want to preheat for starting again, you must close the key of the electric door for about 3 seconds, then repeat the above the process again.

(3) After the diesel engine started, the preheating indicting light continue to blink, it showed that the elelectrothermal plug was heated after processed, when the temperature of cooling rose  $15^{\circ}\text{C}$  or the time which controller set up, the elelectrothermal plug after-heating close automatically.

(4) During controller is running, if more than one elelectrothermal plug, water temperature senor cut off and the

circuitry is damaged, then the controller begin to work, preheating indicating light blinks quickly (but controller will continue to work, hint the customers should check and replace). When the blinking speed of the preheating indicating light slower obviously than before, it showed preheating end, then may start engine.

(5) Must use eleetrothermal plug with the controller equipment matching.

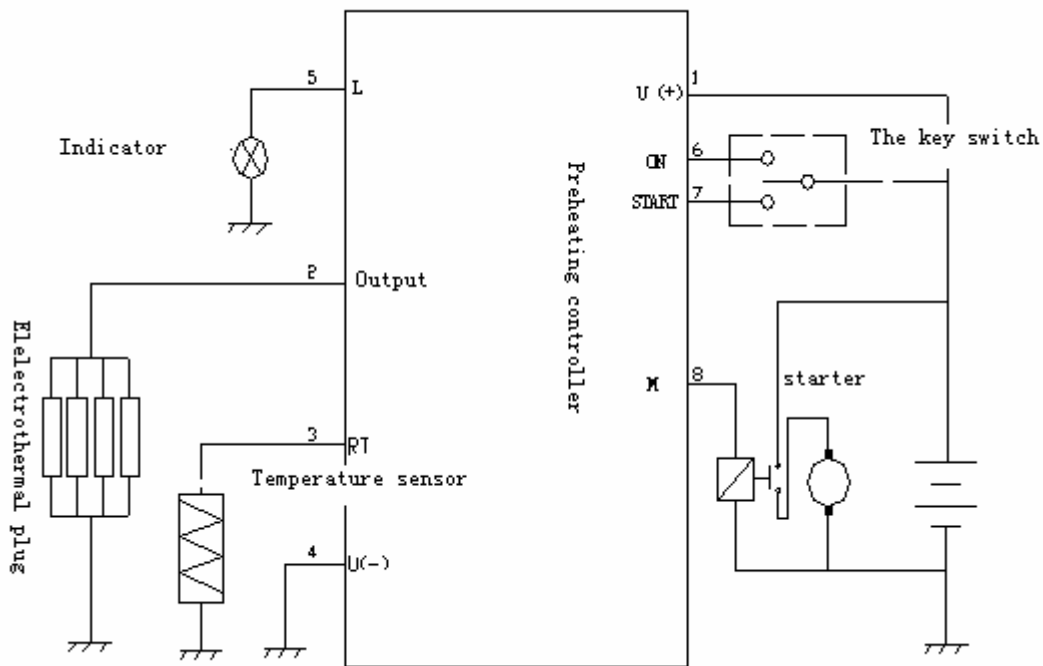

Junction drawing

Note: the drawing only for reference, the detail connection lines see the vehicle electric controller circuit drawing.

### Operating of diesel engine

In most cases, the change of engine speed and load should

be gradually, avoiding sudden and instant step on paddle, except for few circumstances.

Constant attention to paid to the reading of all meters and engine operation conditions (noisy operation and exhaust smoke) during engines or vehicles in operation, and emergency measures must be taken whenever engine operated abnormally.

### Stop of diesel engine

Speed and load can be reduced till 800–1,000r/min and continue to run for 3–5 minutes before engine stop. Whenever engine comes to stop, paddle should be released, switching off fuel shut-off handle to cut-off the fuel into the engine, and then engines stop immediately. Turning the key to cut-off the power connections after vehicles have stopped.

### The others

When engine operations in plateau region and the altitude over 1000m, the injection pump must be readjusted on injection pump test stand, according to the height and related regulation, reduce the fuel cycle delivery to prevent the engine from overload.

# Maintenance specification

## 1. The running - in maintenance rules of the new diesel engine

Run-in operation must be done before a new diesel engine comes into operation, in order to ensure the moving parts smooth running , and prevent these parts from abnormal wear and troubles. Experience proves that engines service life, reliability and economic depend largely on the engine run-in under the instruction of run-in specification.

This stipulation is the basis for DCD and its service enters (stations) to perform “run-in maintenance” service. When the services center (stations) performed its run-in maintenance service, it must be registered and stamped, which is the basis for customers to “guarantee service.”

### 1.1 Specification of engine run-in

(1) Run-in period: Engine run-in normally about 60 hours together with vehicle and if it calculates by mileage, engine must be run-in for about 2500 km.

(2) The load and speed required in run-in period:

| 0-200      | Idler     | Speed                   |
|------------|-----------|-------------------------|
| >200-800   | 50% rated | 70% rated               |
| >800-1500  | 70% rated | 70% rated               |
| >1500-2500 | 75% rated | Not over the most speed |

## 1.2 Conditions in run-in maintenance

- (1) Vehicle mileage is between 2500-3000 km.
- (2) Diesel engine are surely not repaired or adjusted by the customer.
- (3) Sealed devices on the oil control screw of fuel injection pump must be kept complete.
- (4) If the mileage meter was damaged or failed on the vehicle, customer can apply for run-in maintenance service to the nearest technical service center within 15 days (count from the second date when customers collect the vehicle or engine.
- (5) The construction machineries such as loader, fork lift, tractor truck and generating sets follow above “run-in maintenance” condition.

## 1.3 Detail regulations of run-in maintenance

- (1) When run-in operation finished, customer can apply for run-in maintenance at nearest technical service center (station) of Dongfeng Chaoyang Diesel Engine Co., Ltd.
- (2) When the service center found the engine meet the terms of run-in maintenance, it can get the second stipulation of the run-in maintenance service.
- (3) When the run-in maintenance operation finished, the service center should write down clearly item by item and give the

maintenance sheet and certification with as official seal and customer' s stamp or personal signature on it to the customer.

- (4) Invoice (copy is ok) of the vehicle and duplicate of certification can be used as the certificate of run-in maintenance and mass warranty for a new engine.
- (5) If the milege of a vehicle is over 3,000 km, but that the engine did not perform run-in maintenance, and once find fault on the engine, the technical service center will not give “guarantee maintenance” .

#### 1.4 The contents and standards.

| No. | Contents  | Standards  |
|-----|---|--|
| 1   | Change oil in the oil pan                               | CD grade diesel oil as per the temperature.      |
| 2   | Clean oil pan, change paper oil filter element          | With mass part and with manufacture name.        |
| 3   | Clean air filter element and dust disk                  | With mass part and with manufacture name.        |
| 4   | Check torque of con' rod bolt.                          | 118-127N. m                                      |
| 5   | Check torque of main bearing bolt.                      | 216-235N. m                                      |
| 6   | Check head bolt torque.                                 | 108-118N. m                                      |
| 7   | Check and adjust valve clearance                        | Intake & exhaust 0.4 mm (cool)                   |
| 8   | Check and tight the nut in water pump shaft fill grease | Apply 40-45 N. m, lime grease (GB/T5671-1995)    |
| 9   | Check belt tension of the fan and compressor            | Apply vertically 30-40 N. m, deflection 10-15mm. |
| 10  | Check fuel supply advance                               | According to operation manual                    |
| 11  | Tighten external bolt and nut                           | Meet standard (see attachment )                  |
| 12  | Check injector spray                                    | 19 ± 0.5MPa                                      |

|    |   |                             |
|----|---|-----------------------------|
| 13 | Wash inlet screen of fuel transfer pump                 | No dirt nor damage          |
| 14 | Remove controlling sleeve on injection pump             |                             |
| 15 | Intensifier/Turbo-charger engine checks booster running | Running agility, no locked. |

\* turbo-charger engine is 118-127 N.m

\*\* Different engine has different pressure of injection oil , the detail value see the operation instruction of correspond engine.

## 2 Maintenance of diesel engine

Regular maintenance is one of the important items to operate engine rationally. Therefore, careful maintenance can be performed under criterions if the customers want to keep the engines in excellent working condition and serve reliably for long term.

The maintenance criterions below are the content on limited maintenance period and minimal operation worked out under engines good and normal condition. Our customers may make any proper alternations according to local environment and working conditions.

Diesel engine maintenance is graded as follows:

- (1) Routine (shift) maintenance (or regular maintenance) (8-10 hours).
- (2) First grade (accumulative 50 hours in operation, approx.



2000km in vehicles operation).

(3) Second grade (accumulative 200 hours in operation, approx. 8000km in vehicles operation)

(4) Third grade (accumulative 1000 hours in operation, approx. 45000km in vehicles operation)

(5) Maintenance on winter operation.

## 2.1 Routine maintenance

(1) Check lubrication in the pan, if it is not enough, should refill it to the set value, finding out the cause when lubrication level rises or reduces.

(2) Check cooling water capacity, if it is not enough, should refill it.

(3) When does not use deicing liquid, cooling water should be drained out when engines are placed in environment below 5°C.

(4) Check if the connection parts between booster and inlet pipe& exhaust pipe, inlet return oil circuit system is leakage or not, the inlet pipe and adopter between air filter and booster compressor is well, if it is abnormal, should remove it in time.

(5) Check if diesel engine leak oil or cooling water, if it leak, should remove it.

(6) Keeping the engine clean and necessary wash is required.

(7) Getting rid of all troubles.

2.2 First grade maintenance (After maintenance of running 2000km, about accumulative 50 hour operation).

(1) Finish routine maintenance content and items.

(2) Checking the naked bolts, nuts and accessory parts and then tightening them according to the set torque if necessary.

(3) Checking the tension of belts of fan (the belt of air compressor and conditioner), adjust it if it is necessary.

(4) Cleaning fuel and oil element, changing oil and paper element when maintenance is done every 3,000-4,000km.

(5) Cleaning dust in the ash tray of air filter, if the filter element damaged, must replace it.

(6) Fill grease.

2.3 Second grade maintenance (After maintenance of running 8000km, about accumulative 200 hour operation).

(1) The work must be done after the first grade maintenance has completed:

(2) Check injection pressure and spray of injector, adjust it if it is necessary. Checking and adjusting idle speed of engine.

- (3) Check supplying oil advancer, if it is over, should adjust and check delivery pump and injection pump according to the necessary.
- (4) Checking and adjusting the valve gap.
- (5) Cleaning oil pan, oil pump and suction screen.
- (6) When the maintenance is done every 8000-10000km, must change oil element for one time using.
- (7) Change paper fuel element, change the one time fuel filter every 12000-16000km.
- (8) Cleaning air filter and ash tray.
- (9) Washing fuel tank, delivery oil pump filter screen and pipes.
- (10) Blowing away the duct in electric generator and starter by compressed air, checking all parts and keeping every part in good working condition, meanwhile, the improper part should be corrected.
- (11) Check booster rotator working according to the necessary, dial rotator with hand, if return running steady and free running, it showed it is normal, or must disassembly inside parts. Here note: when check rotator working, must ensure around disassembly position and outside environment must clean, and when assembly it again, can't have the object to

drop into turbo-charge system, or may cause the result heavily.

Otherwise, in normal, disassembly and assembly need special equipment and tool, in general only booster manufacture factory and service center is with this condition. So if not necessary, please customers don' t disassembly or assembly booster assembly.

(12) Disassembly compressor case according to necessary, check if the compressor end of booster is leakage or not, at the same time washing compressor case inside lumen and compressor vane surface, but must pay attention no to damage vane when washing.

2.4 The third maintenance (After maintenance of running 45000km, about accumulative 1000 hour operation)

- (1) Finish items and contents of the second grade maintenance.
- (2) Cleaning cooling system.
- (3) Cleaning oil filter.
- (4) Replace air filter element after it was continued maintenance five times or used one year.
- (5) Replace the valve seal sleeve if necessary.
- (6) Checking the bolts on cylinder head, main bearing of connect-rod, and tighten the loose ones till their set value are met.

(7) Checking water pump internal seals and refilling fresh grease.

(8) Removing and checking electric generator and starter, cleaning maintenance them and refilling new grease.

(9) Removing and maintenance of cylinder head and regrinding valve is usually decided according to working condition.

(10) Adjusting injection pump according to working condition.

(11) Checking supply oil delivery of oil pump and in-shot valve is usually decided according to working condition.

(12) Disassembly booster assembly, and replaced wearing parts easily.

## 2.5 The judgment of overhaul for diesel engine

### (1) Rate of increase for oil consumption

If oil consumption rate of new vehicle is (can run km every L oil or h) 100%, when it reduced 50%, it needs to overhaul.

### (2) The increasing rate of fuel consumption

If fuel consumption rate of new vehicle is (can run km every L fuel or h) 100%, when it reduced 60%, it needs to overhaul.

### (3) Noise inside

The causes of noise is too much, if it is really because it wore too big or overheated, or because it is caused by using & maintenance incorrectly, must be overhauled early.

## 2.6 Maintenance on winter operation

Engine must be specially cared when operate at below 5°C.

- (1) Winter engine oil and fuel must be used to engines and special attention must be paid to water content in fuel to avoid fuel circuit block.
- (2) Deicing liquid had better filled into cooling system, or cooling must be drained when the water temperature fall down to 40–50°C after engine has stopped.
- (3) Vehicles should not be put in the open in winter, or cooling water and engine oil must be heated to preheated the engines when starting. Soon after all this has been prepared, engine may start without much difficulties at environmental temperature below -20°C.

## The chapter 5      **Diagnosis of diesel engine fault & trouble shooting**

**Every system fault symptom and effect of diesel engine**

### **Cylinder-block & cylinder-head**

| <b>Position</b>                                       | <b>Fault</b>  | <b>Symptom and effect</b>  |
|---|---|--|
| <b>Cylinder<br/>-sleeve</b>                           | <b>Excessive wear</b>   | <b>Low compress pressure, black smoke, start difficultly .<br/>Blue smoke, engine oil leaks into cylinder<br/>Excessive leakage air, and excessive blow-by</b>   |
|   | <b>Cooling poor</b>   | <b>Tear pistons</b>  |
|   | <b>Protrude height is too big or uneven</b>   | <b>Air leakage between cylinders, hunting, leakage and white smoke</b>   |
| <b>Cylinder-head washers, and cylinder-head bolt.</b> | <b>Quality of the cylinder-head is poor, the tighten torque of cylinder-bolt is not enough.</b>   | <b>Cylinder-head washer impact, leakage air enters water circuit, make the water circuit not circulation.<br/>Leakage, white smoke, water in oil sump, can't start when it is heavy. Dragging will damage connect-rod.<br/>Leakage oil enters into cooling water</b> |
| <b>Cylinder-block , cylinder-head</b>                 | <b>Casting sand inclusion, the technology plug loosen, crack and so on.</b>   | <b>Water leaks oil sump, and oil surface rising.<br/>Leakage oil enters into cooling water.</b>  |
| <b>Timing gear</b>                                    | <b>Phase of air distribution is wrong.<br/>Timing of injection oil is wrong.<br/>Excessive                      wore,<br/>clearance wrong</b> | <b>Starting difficultly or not starting<br/>Starting difficultly or not starting<br/>Abnormal noise</b>  |

## Crank connect-rod framework

| Position  | Fault  | Symptom and effect   |
|---|--|--|
| Piston  | Excessive wear on the skirt, the clearance of matching cylinder is wrong<br>Cooling is bad, there is impurity in lubrication oil | Engine oil leaks into cylinder, black smoke.<br><br>Tear cylinder-sleeve   |
| Piston-ring   | Excessive wear counter-installation of rings, sticking   | Low compress pressure, black smoke, start difficultly.<br>Blue smoke, engine oil leaks into cylinder<br>Excessive leakage air, and excessive blow-by |
| Crank-shaft and the main bearing, connect-rod and connect0rod bearing | Big clearance, loosen connect-cover, low oil-pressure or no oil  | Pressure is too low, abnormal noise.<br>Seize  |

## Air distribution framework

| Position               | Fault  | Symptom and effect   |
|------------------------|--|--|
| Air filter             | Clogged  | Black smoke, loss power, start difficultly.  |
| The clearance of valve | Too big<br><br>Too small   | Black smoke, not fire, fuel enters into oil sup, oil surface rises.<br>Abnormal noise when heavily |
| Valve pipe             | Oil seal leakage   | Blue smoke   |
| Valve and valve seat   | Oil seal is not closed.  | Low compress pressure, black smoke, power is not enough, start difficultly.                        |
| Booster                | Dirty, leakage, eyewinker restricts rotor                                | Air and power are not enough, black smoke  |
|                        | Bearing wore, rotor touched, the eyewinker enter into, parts deformation | Abnormal noise, rotor turns is not agility   |
|                        | Oil seal ring damage   | Oil enter cylinder-block, blue smoke.  |



|  |  |  |
|--|--|--|
| <b>Rocker-arm</b>                          | <b>Front and back seat installed wrong</b>   | <b>Not add oil, burnt</b>                                  |
| <b>Camshaft-sleeve</b>                     | <b>Turning restricted inlet port</b>         |  |
| <b>Push-rod chamber</b>                    | <b>Return-oil hole is too small, clogged</b> | <b>Blow-by with oil</b>                                    |
| <b>Valve spring, push lever and tappet</b> | <b>Damage</b>                                | <b>Air distribution is turbulent, power is not enough.</b> |

## Supply oil system

| <b>Position</b>          | <b>Fault</b>   | <b>Symptom and effect</b>  |
|--------------------------|--|--|
| <b>Fuel</b>              | <b>Quality is poor<br/>There is water</b>  | <b>Black smoke, power is not enough<br/>White smoke, hunting</b>   |
| <b>Advance</b>           | <b>Big<br/>Small</b>   | <b>Black smoke<br/>White smoke, disperse heating to the cooler is big, may cause high temperature, too big or too small make starting difficultly</b>  |
| <b>Oil passage</b>       | <b>There is air<br/>Restricted, inlet oil is not smooth<br/>Backpressure valve of drain oil bolt is failure.</b>   | <b>Hunting, not starting<br/><br/>Power is not enough.</b>   |
| <b>Delivery oil pump</b> | <b>Not supplying oil<br/>Seal washer damage</b>  | <b>Not starting or difficultly<br/>Fuel enters into oil sump, oil surface rose.</b>  |
| <b>Injection pump</b>    | <b>Supplying oil volume is too big (one-cylinder)<br/>Supplying oil is uneven<br/>The pull lever of supplying oil is failure or restricted<br/>Loosen handle-arm<br/>Seal of case body is not good<br/>Supplying oil is small<br/>Wear</b> | <b>Black smoke<br/><br/>Engine running away<br/>Hunting or running away<br/><br/>Can't control, running away.<br/>Fuel enter into oil sump<br/><br/>Power is not enough<br/><br/>Power is not enough</b> |
| <b>Governor</b>          | <b>Parts loosen<br/>Parts damage</b>   | <b>Hunting, unsteady<br/>Engine running away</b>   |

|          |   |  |
|----------|---|--|
|          | <p>The position of idling speed bolt is wrong</p> <p>The position of high speed limit bolt is wrong</p> | <p>Idling unsteady, easily flameout or idling is high.</p> <p>Running away or supplying oil is not enough, and power is not enough.</p>                      |
| Injector | <p>Dropping oil, spray is not good</p> <p>Restricted Pressure is uneven</p>                             | <p>Black smoke, in winter white smoke, power is not enough. When heavily, not fire, and fuel enters into oil sump.</p> <p>Abnormal noise.</p> <p>Hunting</p> |
| Advance  | Loosen  | <p>Supplying oil angle is uneven</p> <p>Hunting</p>  |

## 5 Lubrication system

| Position                   | Fault                   | Symptom and effect  |
|----------------------------|-------------------------|---|
| Oil                        | Trademark is wrong      | Too watery oil pressure is low.   |
|                            | Quality is poor         | Too thick, oil pressure is high a little.<br>Moving parts wore greatly, restricted. |
| Oil sump                   | Oil surface is too high | Blow-by with oil<br>Oil leaks into cylinder, blue smoke.                            |
|                            | Oil is not enough       | Supplying oil is not enough, pressure is low.                                       |
| Oil meter (induction plug) | Failure                 | Can't show oil pressure   |
| Steady valve               | Restricted or wore      | Oil pressure is too low or too high.  |
| Oil pump                   | Wore, leakage oil       | Oil pressure is low.  |
| Oil filter                 | Restricted, by-pass     | Tear bearing-shell easily<br>Low pressure   |
| Oil cooler                 | Leakage                 | Water is with oil   |
| Oil passage                | Leakage                 | Water is with oil<br>Low pressure   |
|                            | Clogged                 | A part wore, burn.  |

## 6 Cooling system

| Position   | Fault  | Symptom and effect  |
|------------|--|---|
| Cooling    | Not meet temperature requirements                                | Frozen in winter, swelling damage parts.  |
| Thermostat | Damage, failure  | Water temperature is too high or too low.   |
| Water pipe | There is air in pipe   | Drain water pipe can't flow water, or water is a little, water temperature is too high. |
| Radiator   | Disperse area is too small, deposit and clogged                  | Water temperature is too high.  |
| Fan belt   | Tension force of fan belt is not enough<br>Fan, water pump skid. | Water temperature is too high.  |
| Water pump | Excessive wore   | Water is not enough, water temperature is too high.                                     |

## The other system

| Position                     | Fault                       | Symptom and effect   |
|------------------------------|-----------------------------|--|
| Battery                      | Voltage is not enough       | Starting difficultly or can't start                          |
| Connection                   | Falling off or not starting | Starting difficultly or can't start                          |
| Starter                      | Damage                      | Can't start  |
| Generator                    | Damage                      | Normal running automobile<br>Battery pressure is not enough. |
| Compressor                   | Wore                        | Braking pressure is not enough.                              |
| Electric equipment and meter | Connection loosen or damage | Not showing or showed wrong.                                 |

## 2 Main Failures of Diesel Engine and way of shooting

### A. Difficult to start

#### (1) Starter Doesn't Run

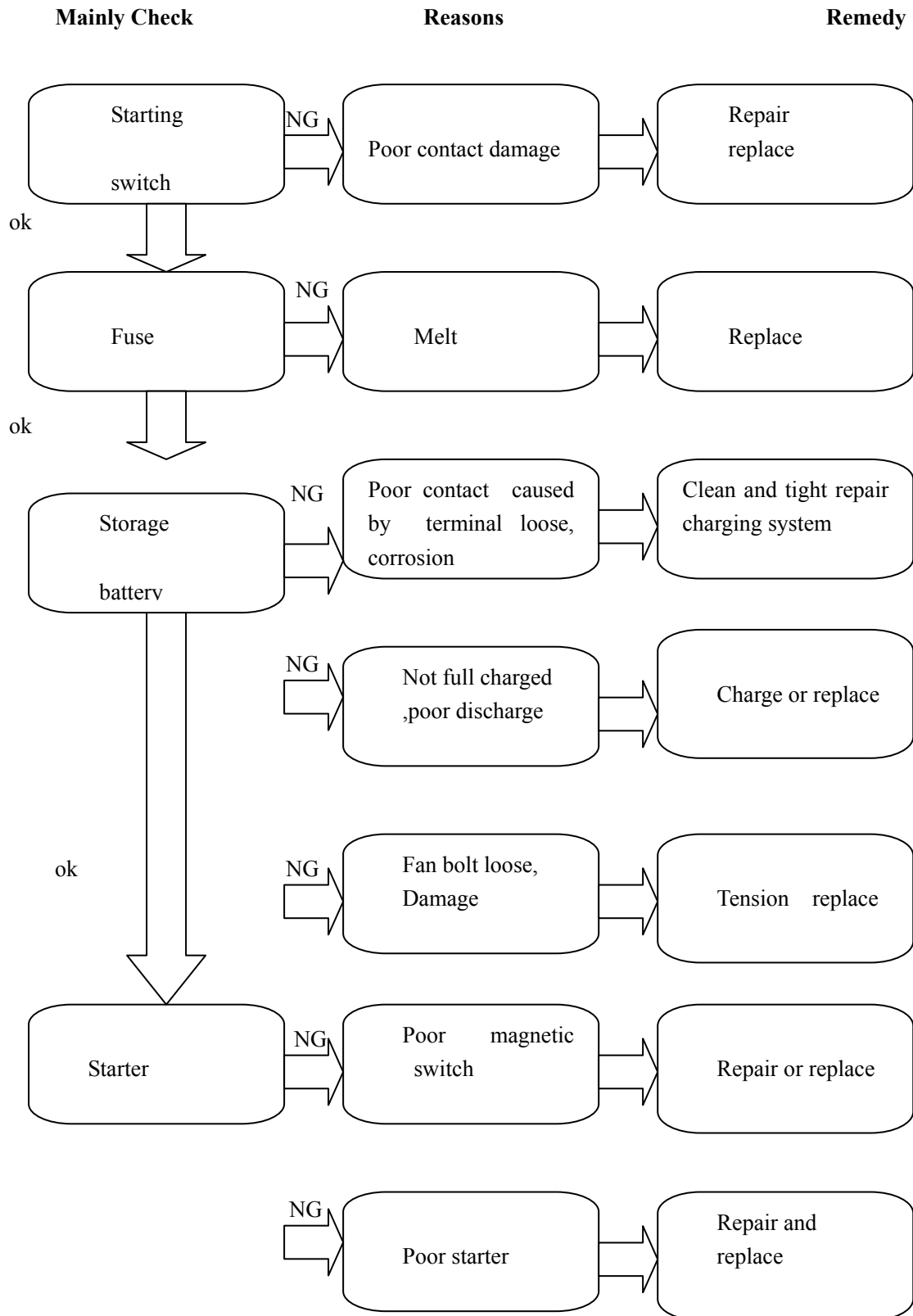

## (2) Starter runs but engine doesn't run

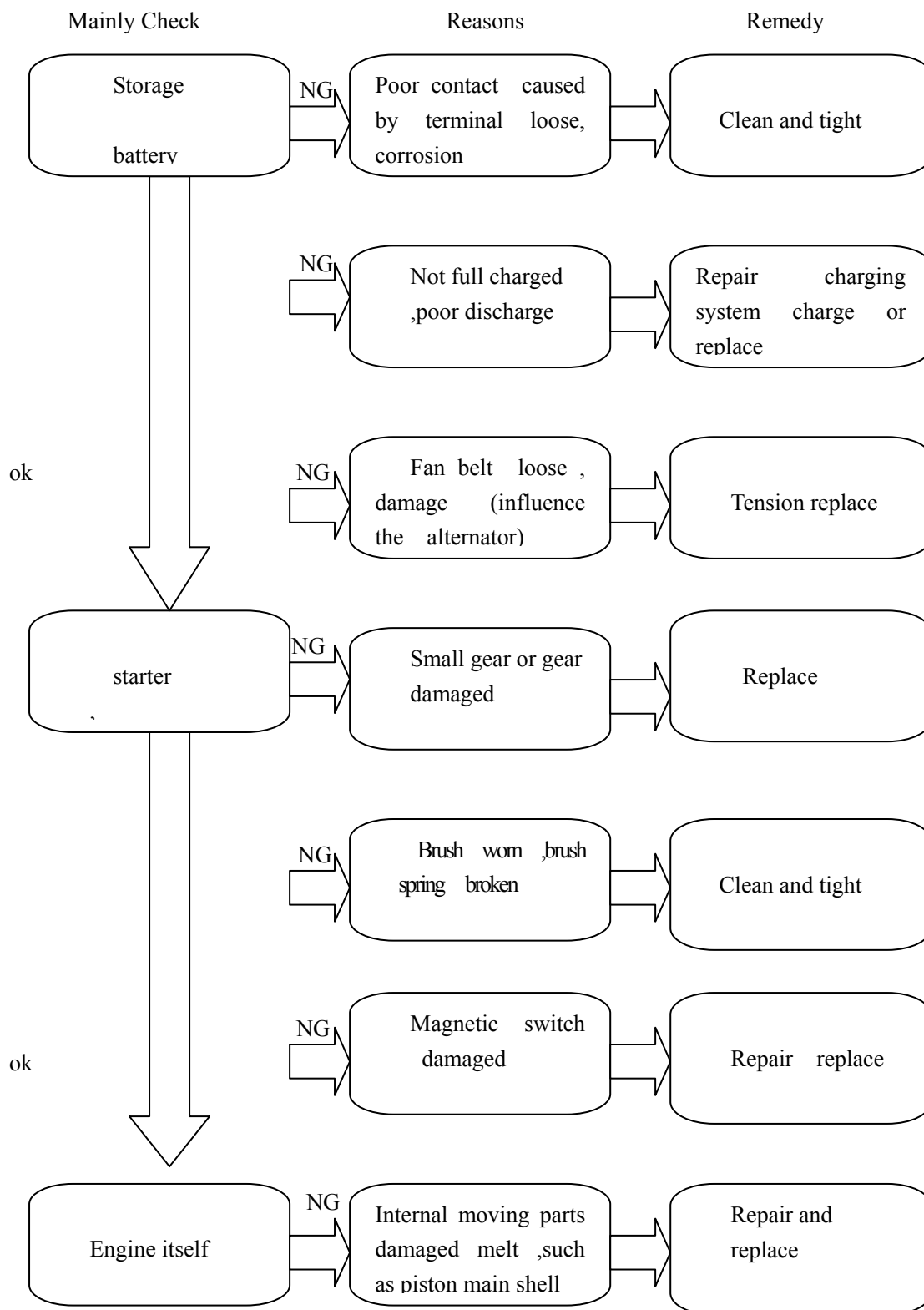

### (3) Starter runs ,But Engine Doesn't Work

Not supply for injection pump

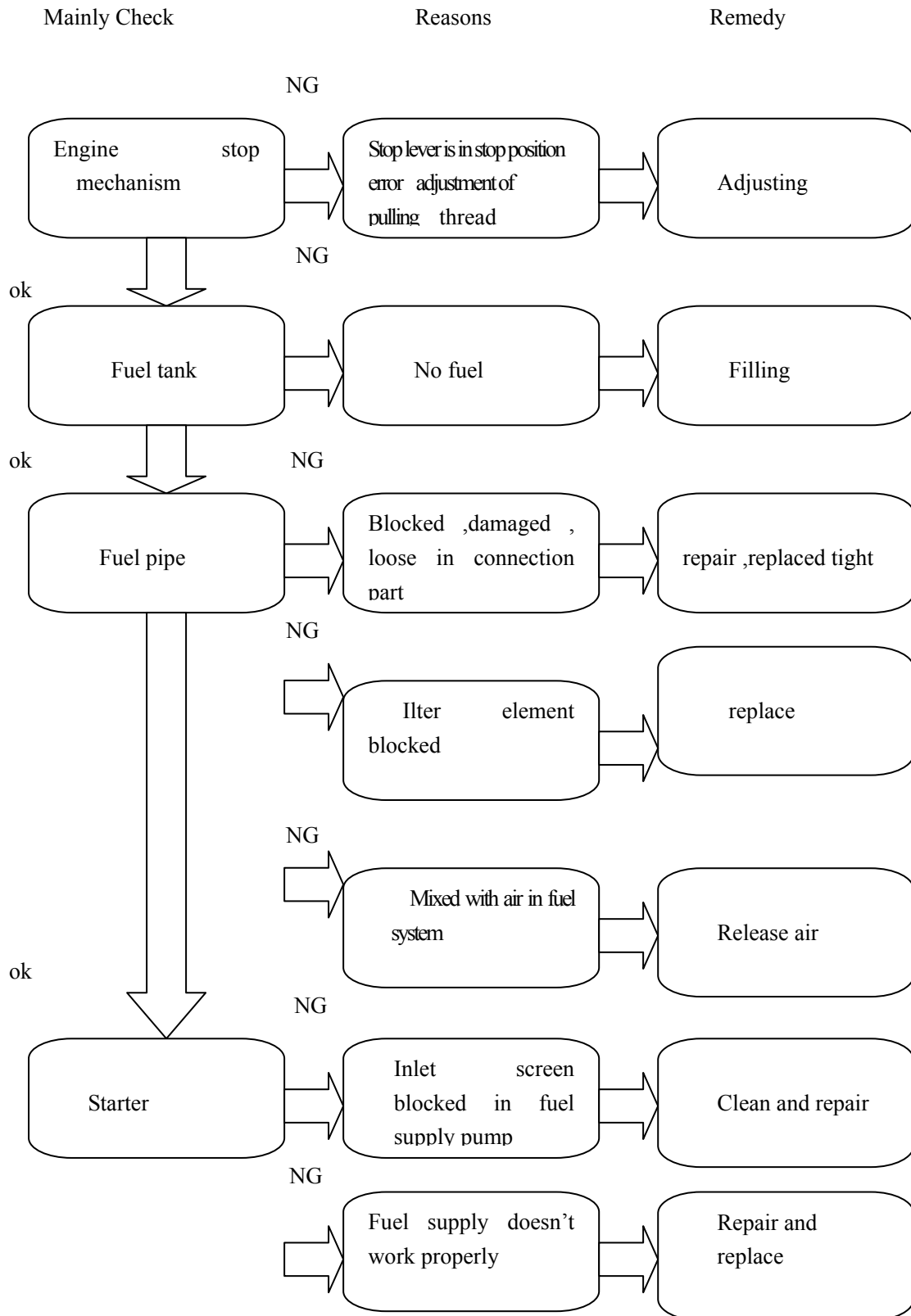

# Oil Supply Fuel Pump

Mainly Check

Reasons

Remedy

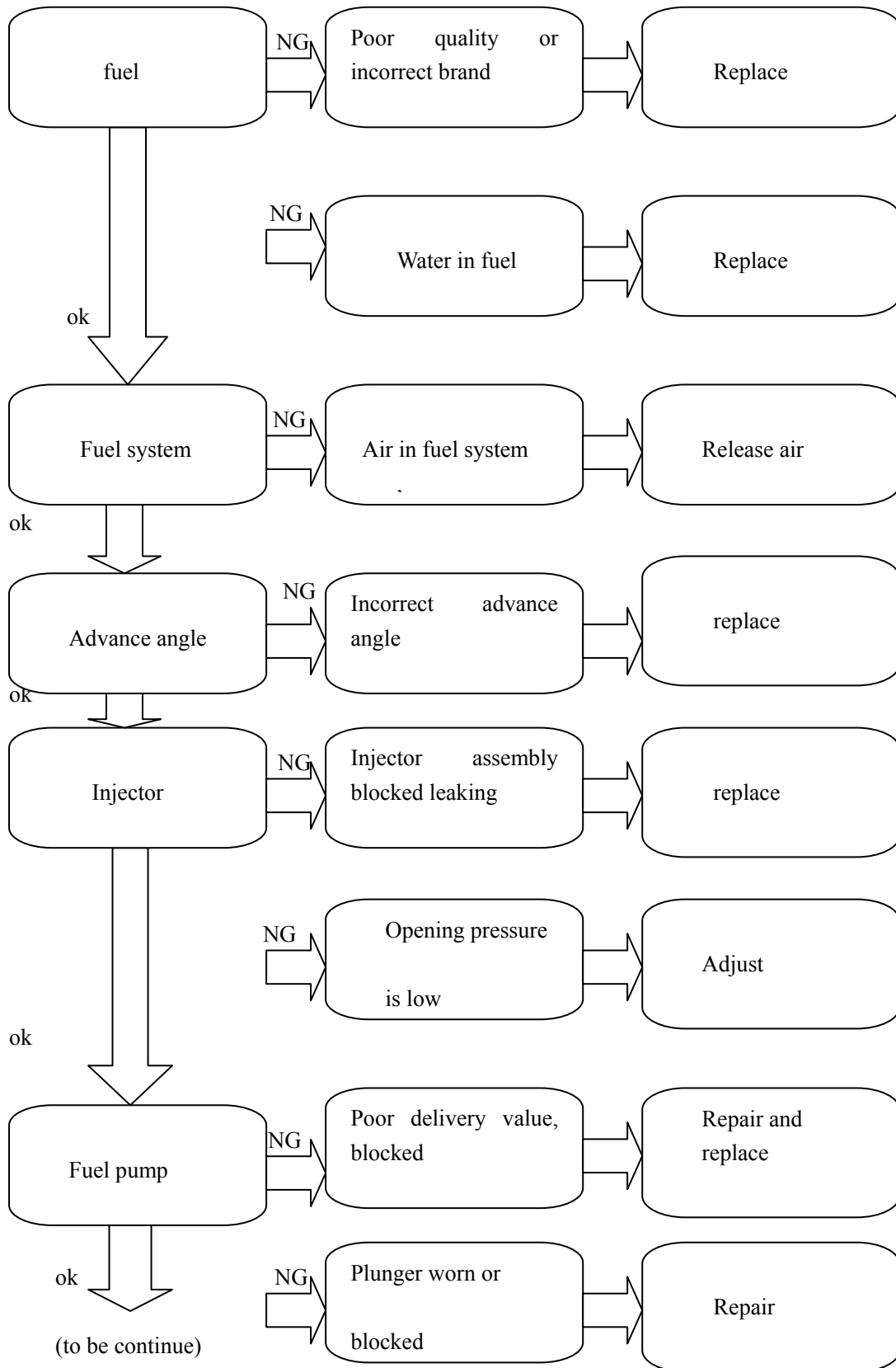

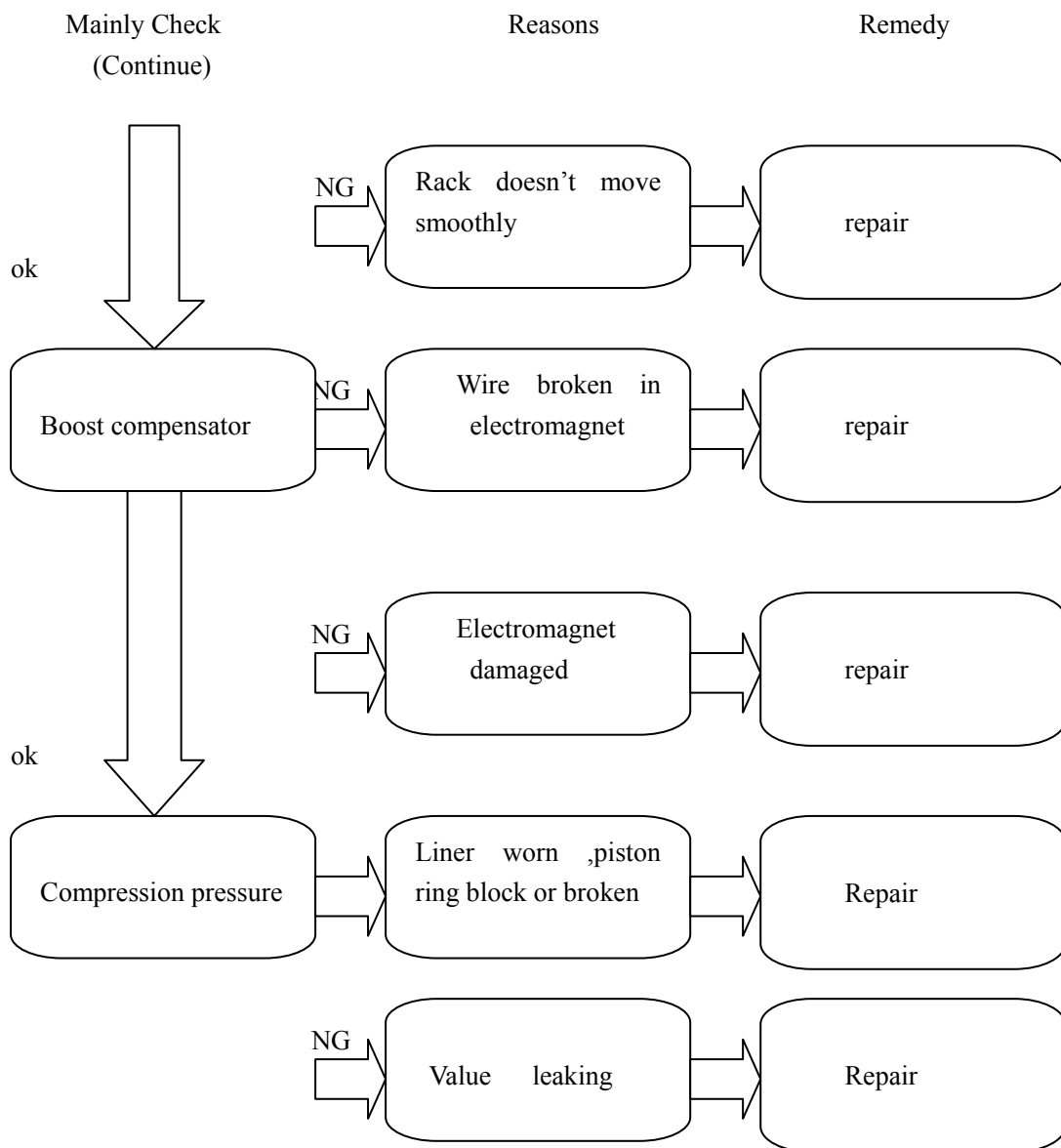

## Low temperature

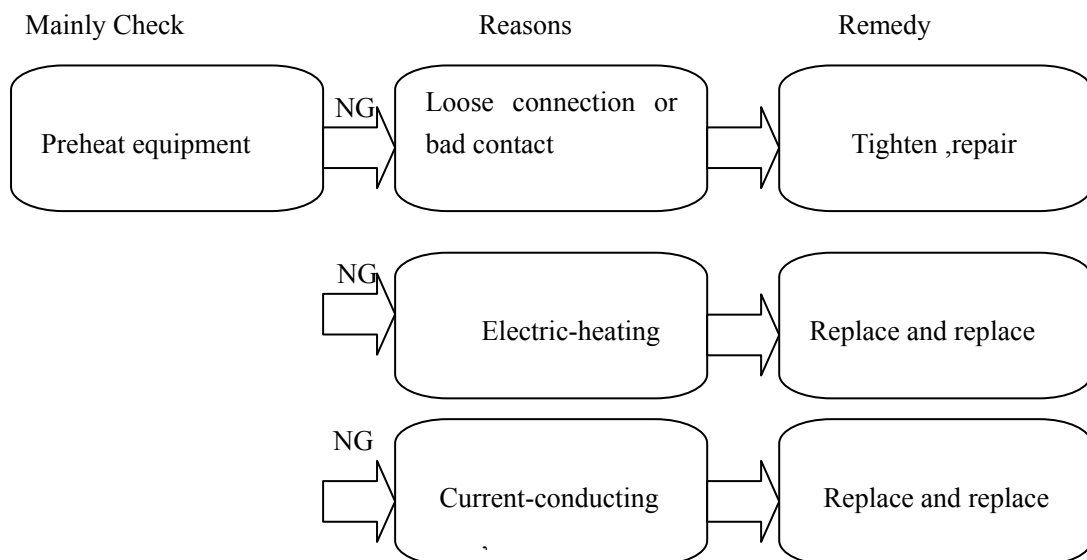



## 2.2 Idle Speed Is Unstable

Mainly Check

Reasons

Remedy

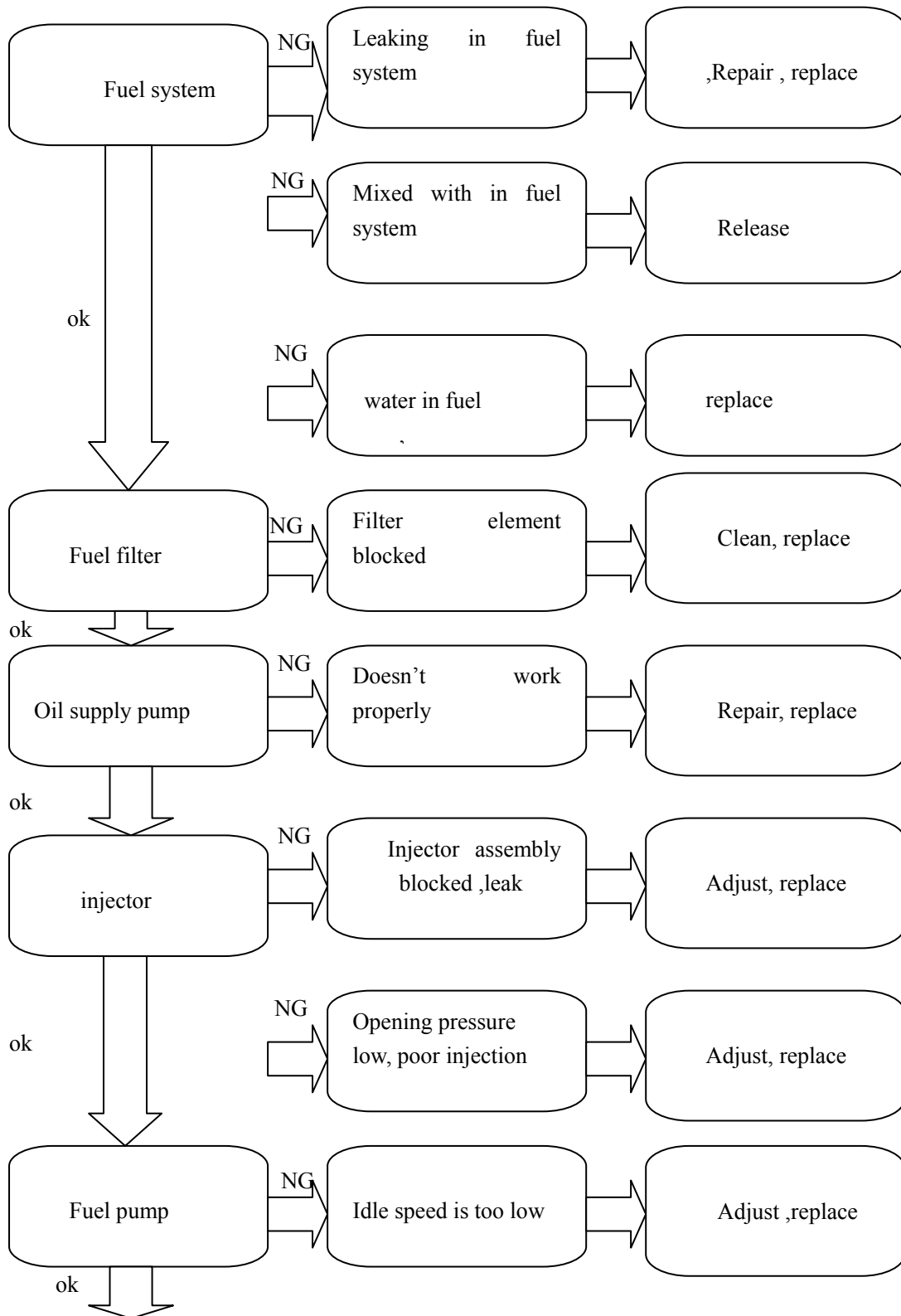

(to be continue)

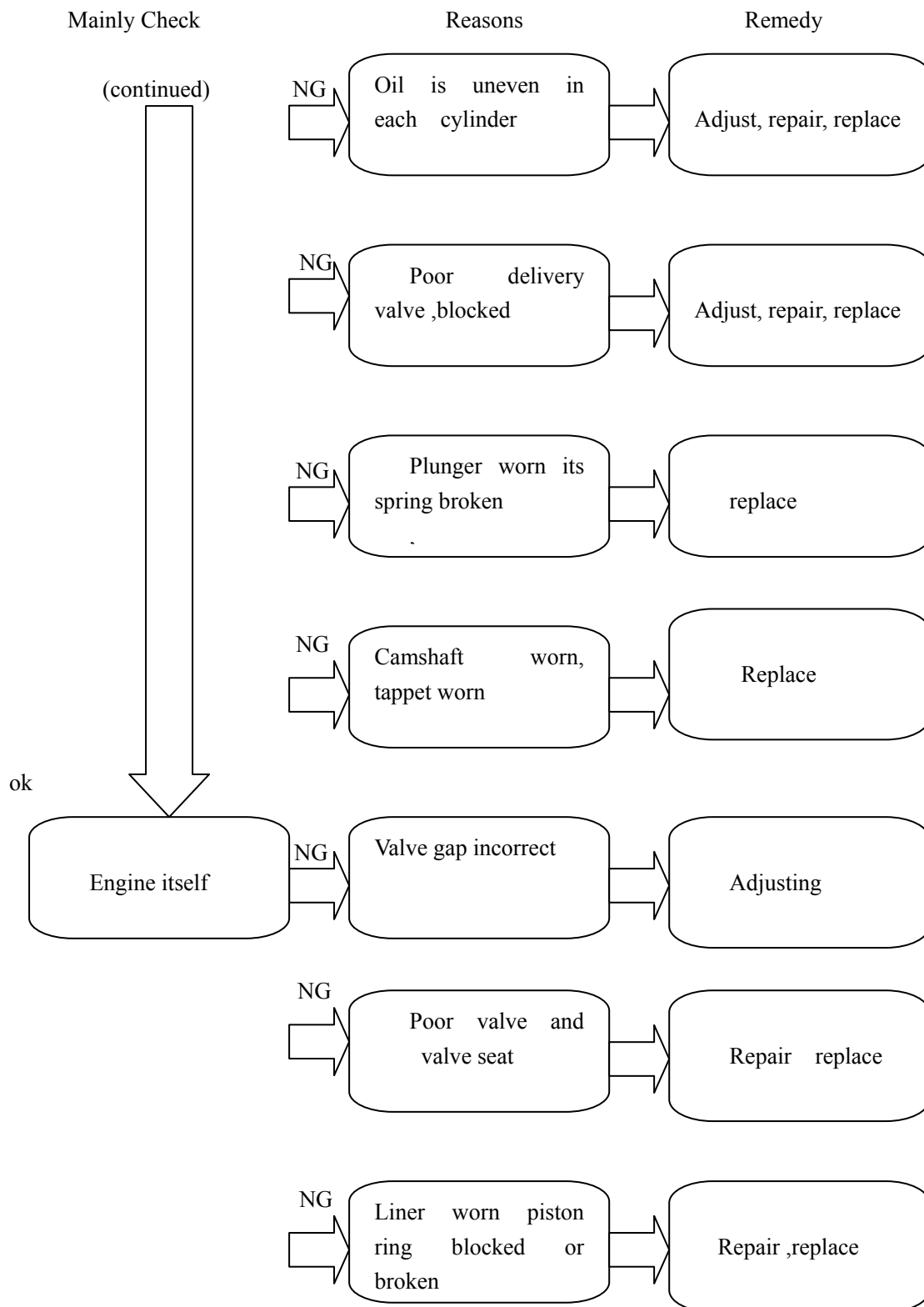

## 2.3 Insufficient power

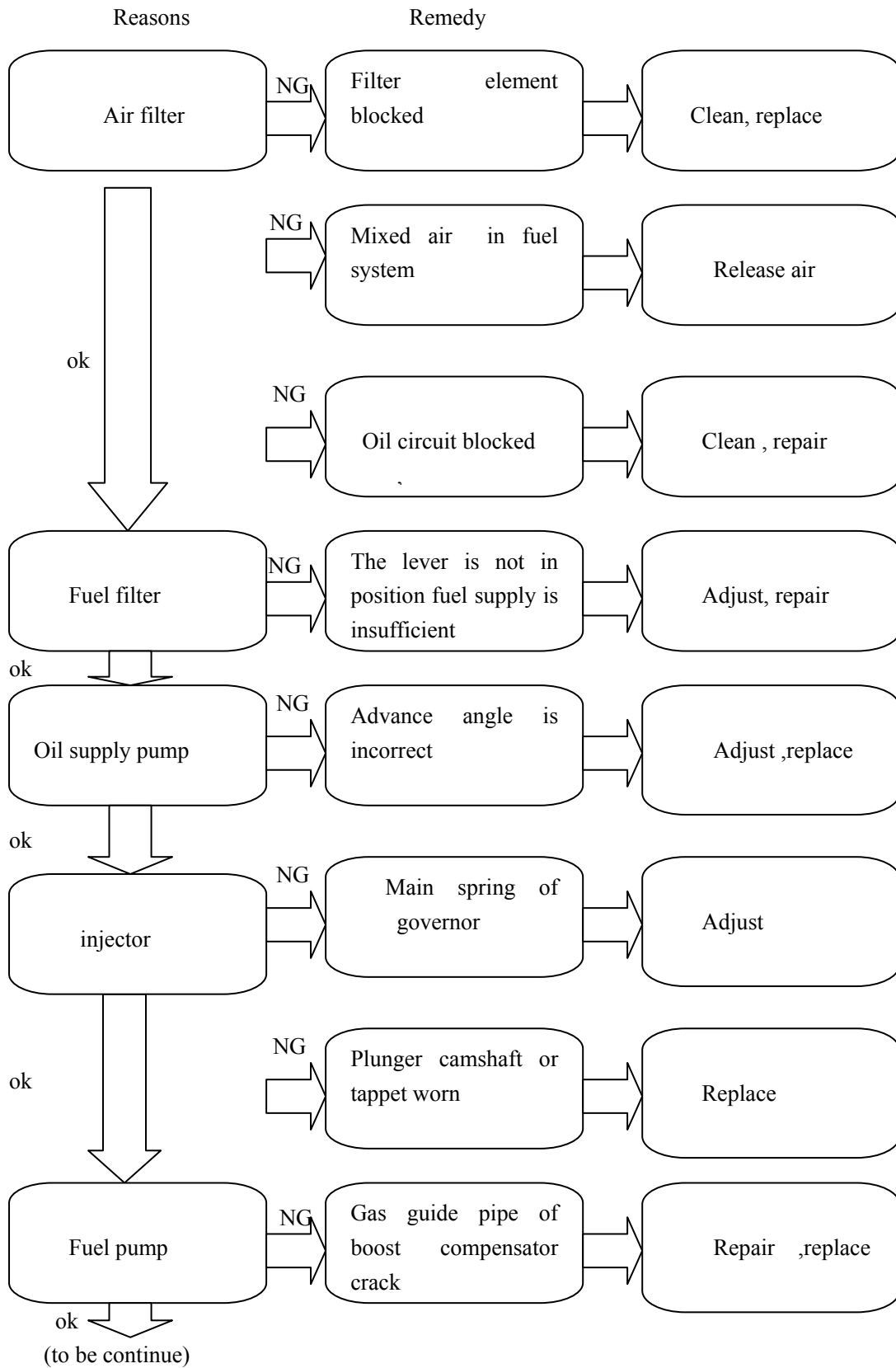

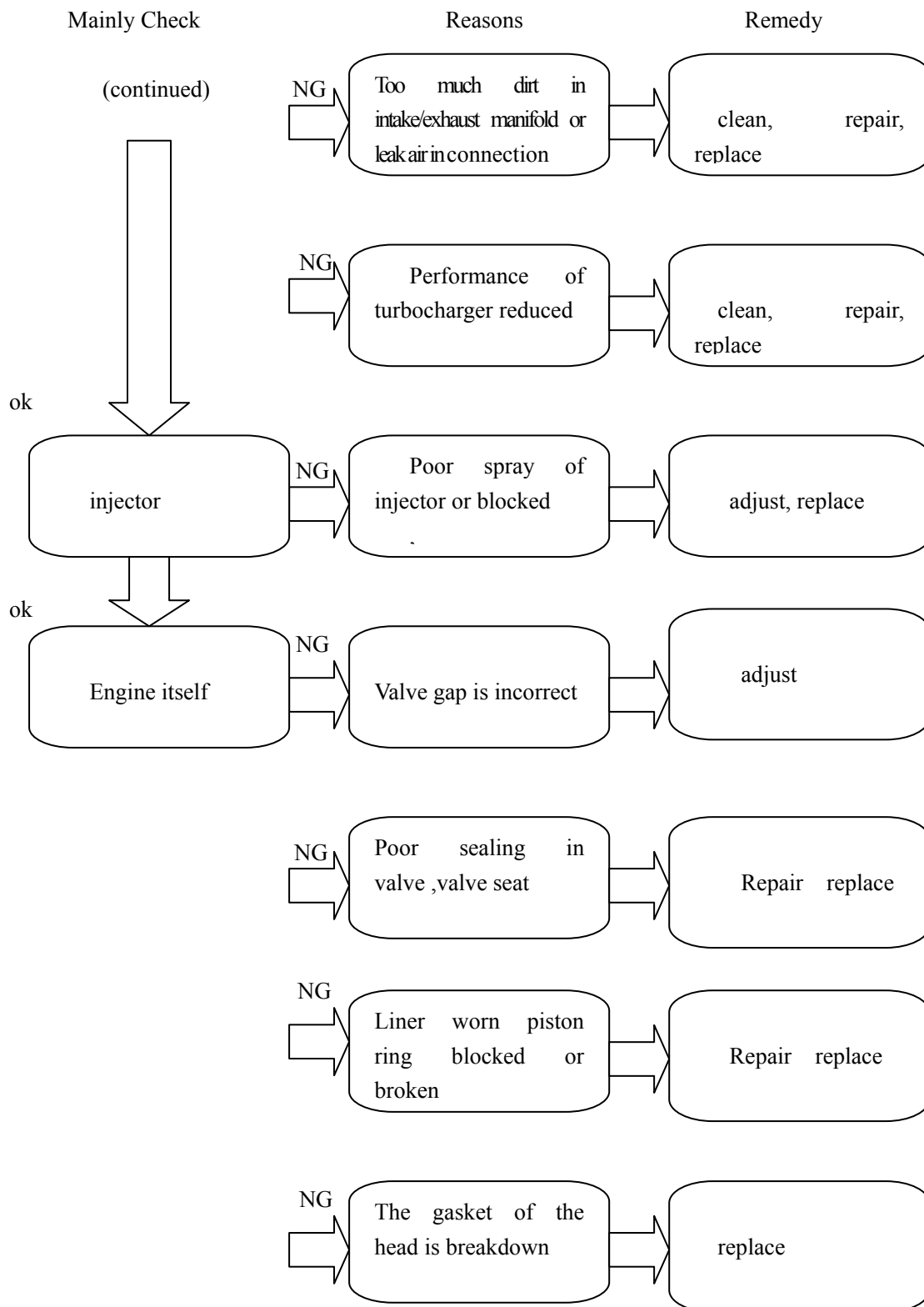

## 2.4 Fuel Consumption Is Big

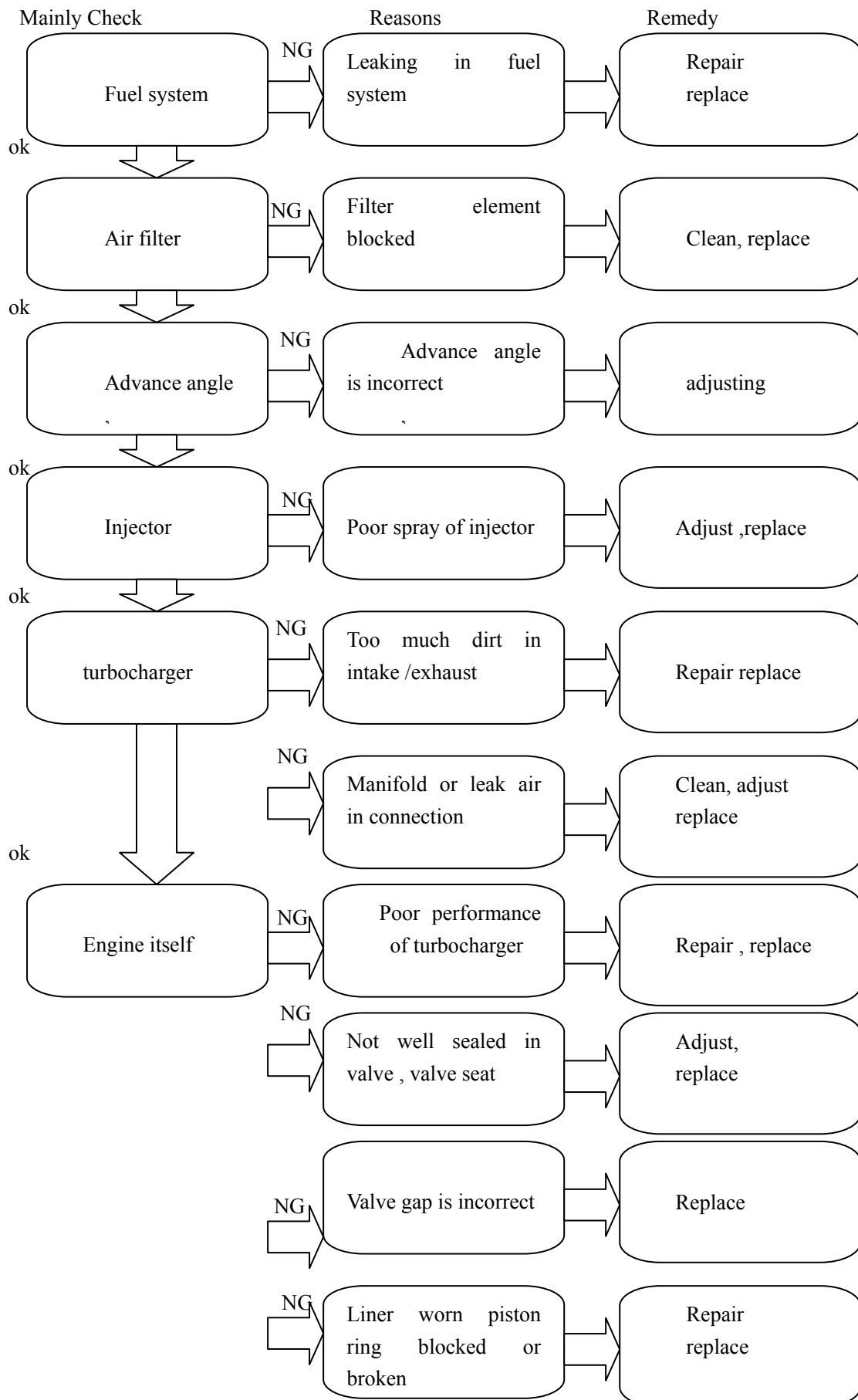

## 2.5 Oil Consumption Is Big

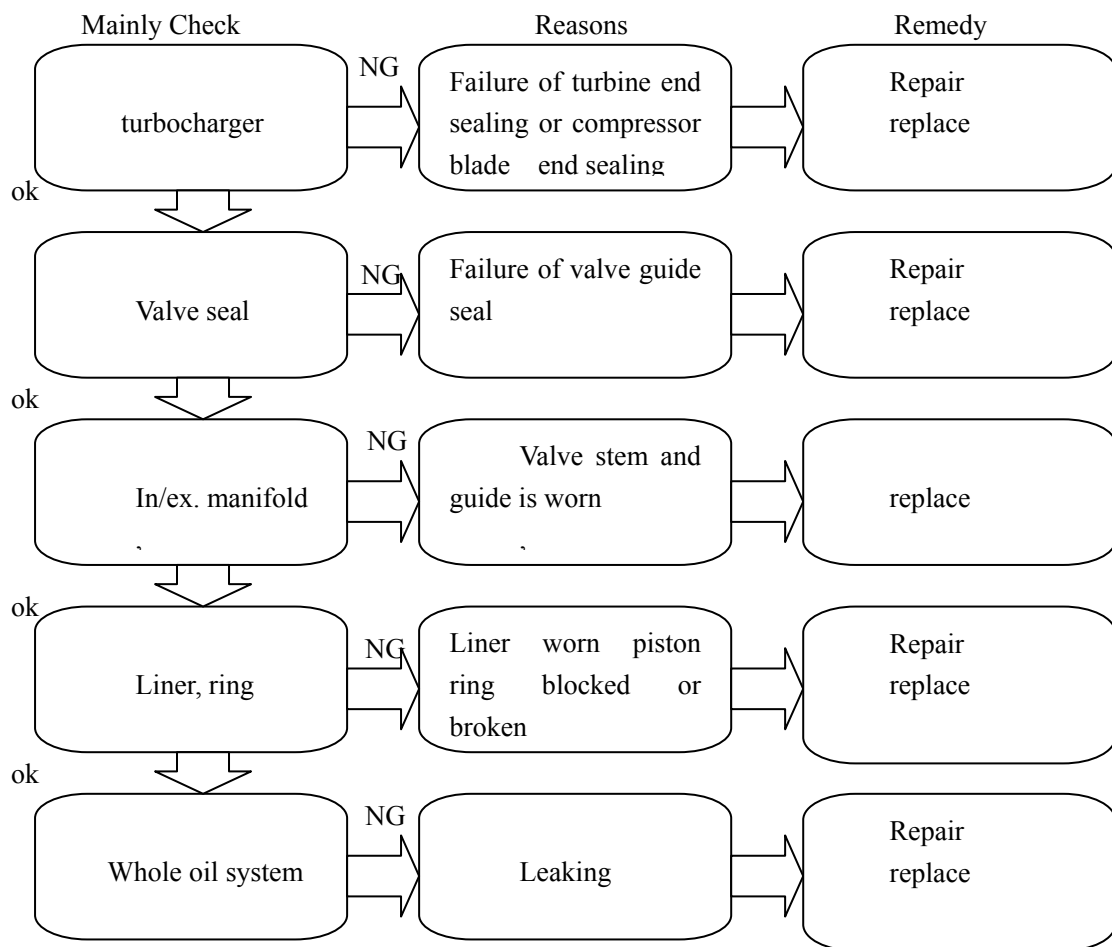

## 2.6 Water Temperature of Engine Outlet

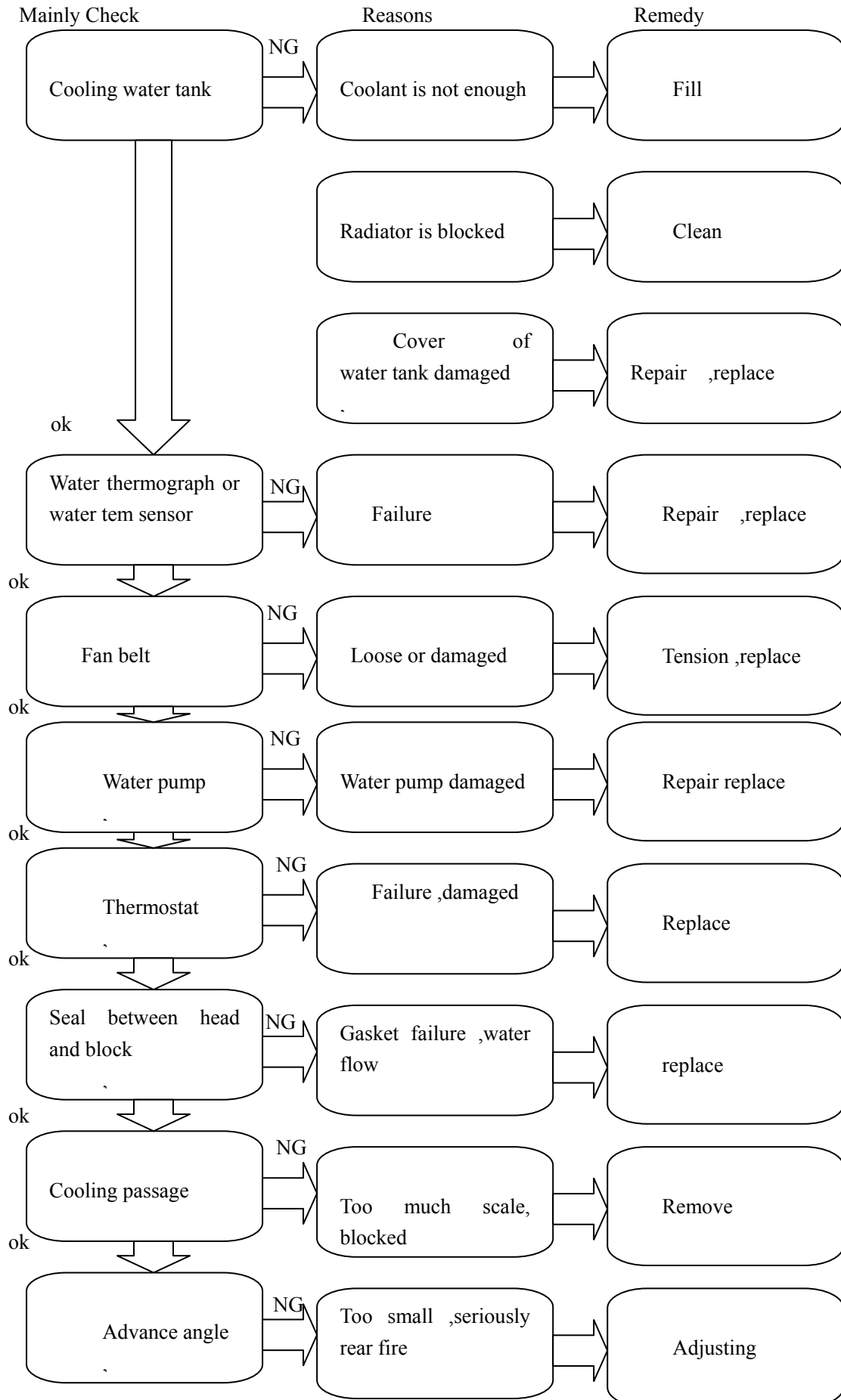

## 2.7 White Smoke In Exhaust

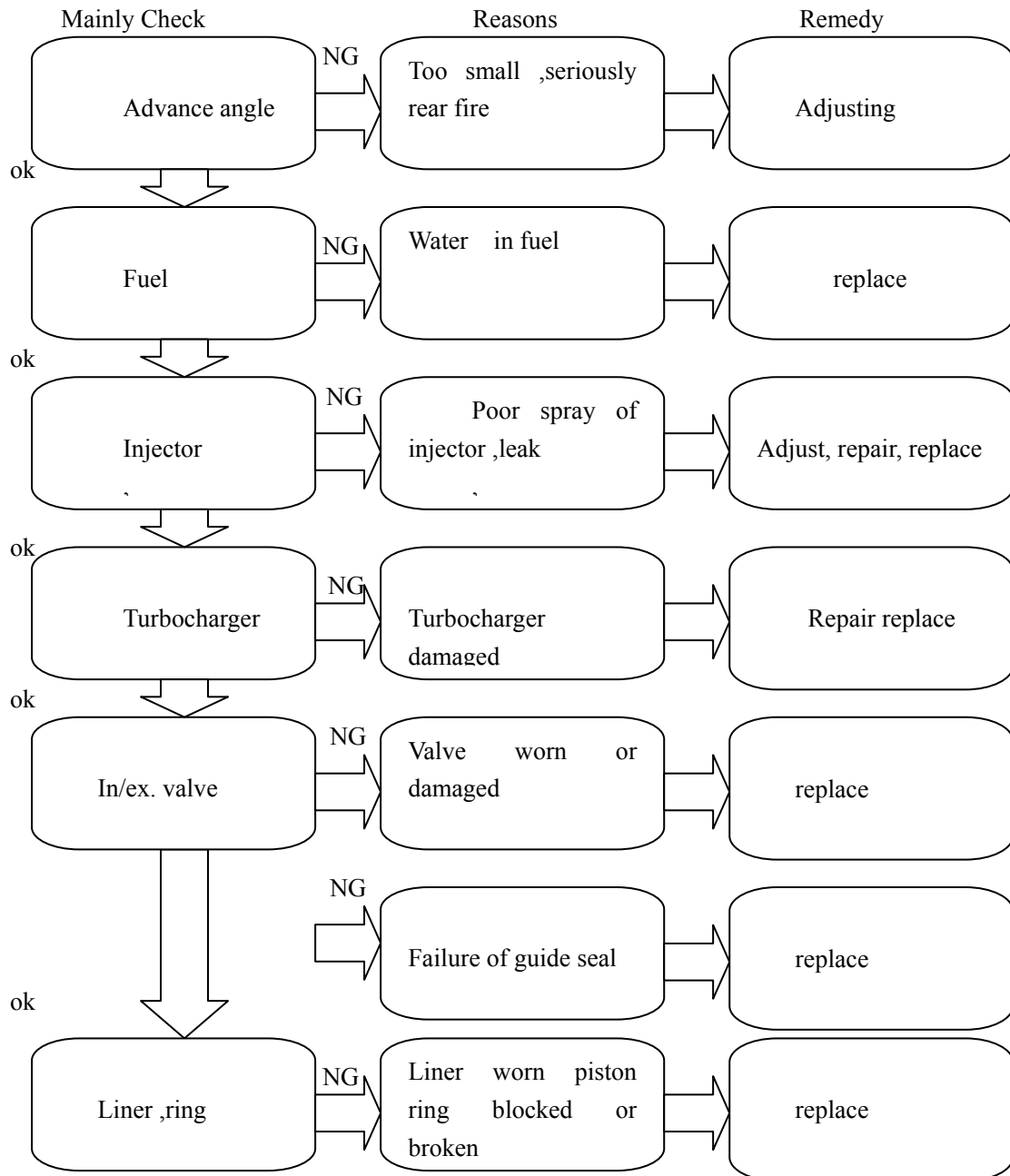



## 2.8 Black Smoke In Exhaust

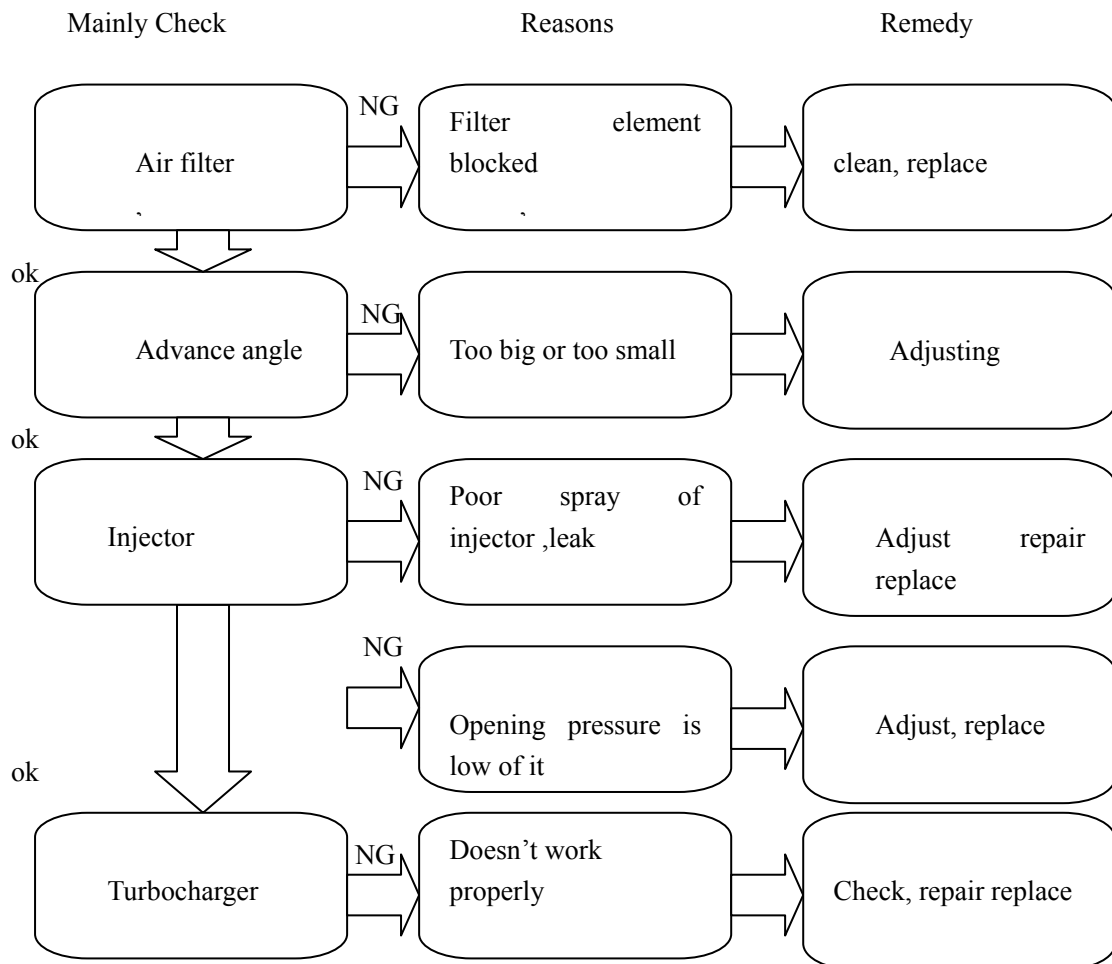

## 2.9 Oil Pressure Is low

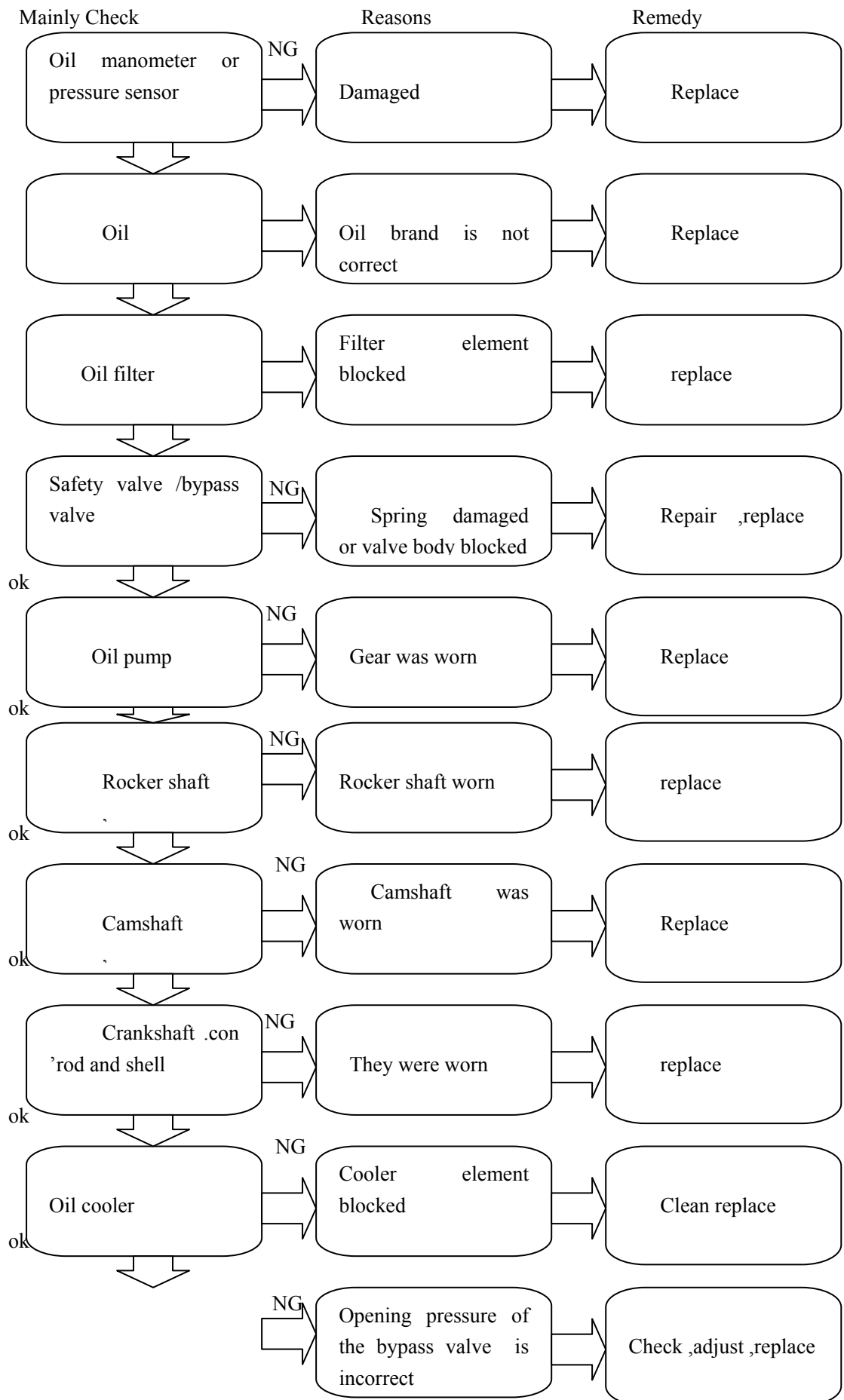

## 2.10 Failure Of Turbocharger

### 1. Power is insufficient

#### Black Smoke in Exhaust

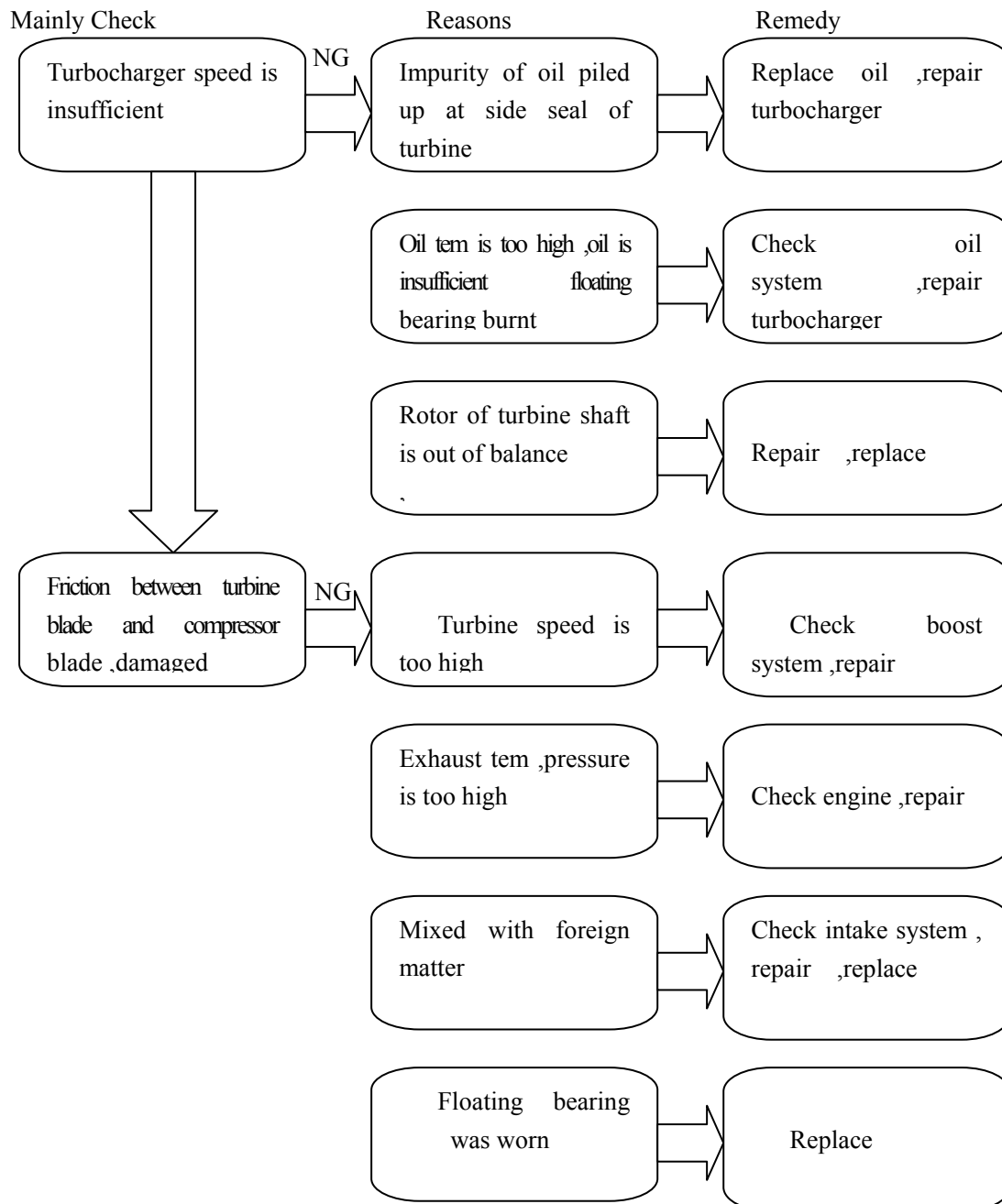

## White Smoke In Exhaust

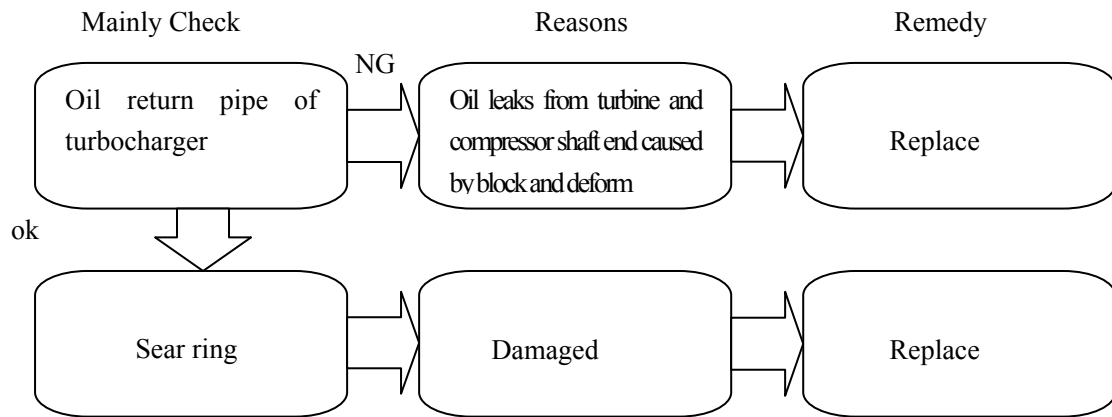

### (2) Oil Consumption Is Too Big

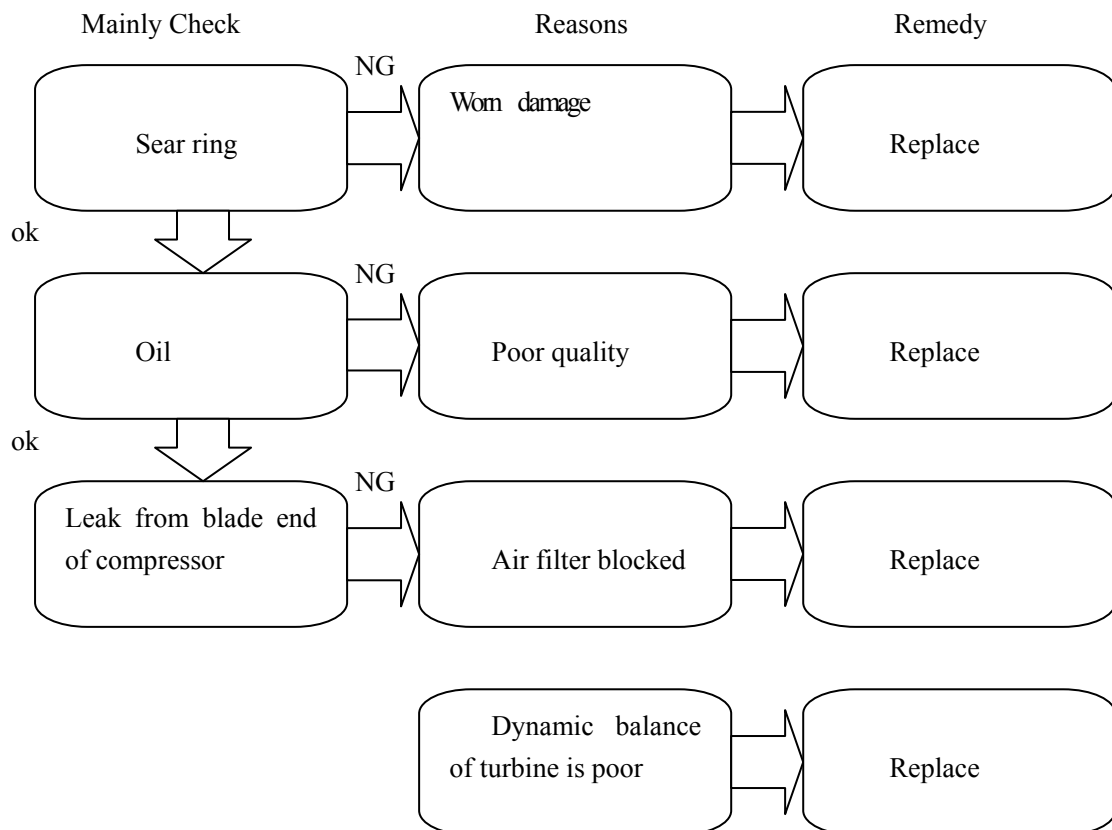

### (3) Abnormal Sound

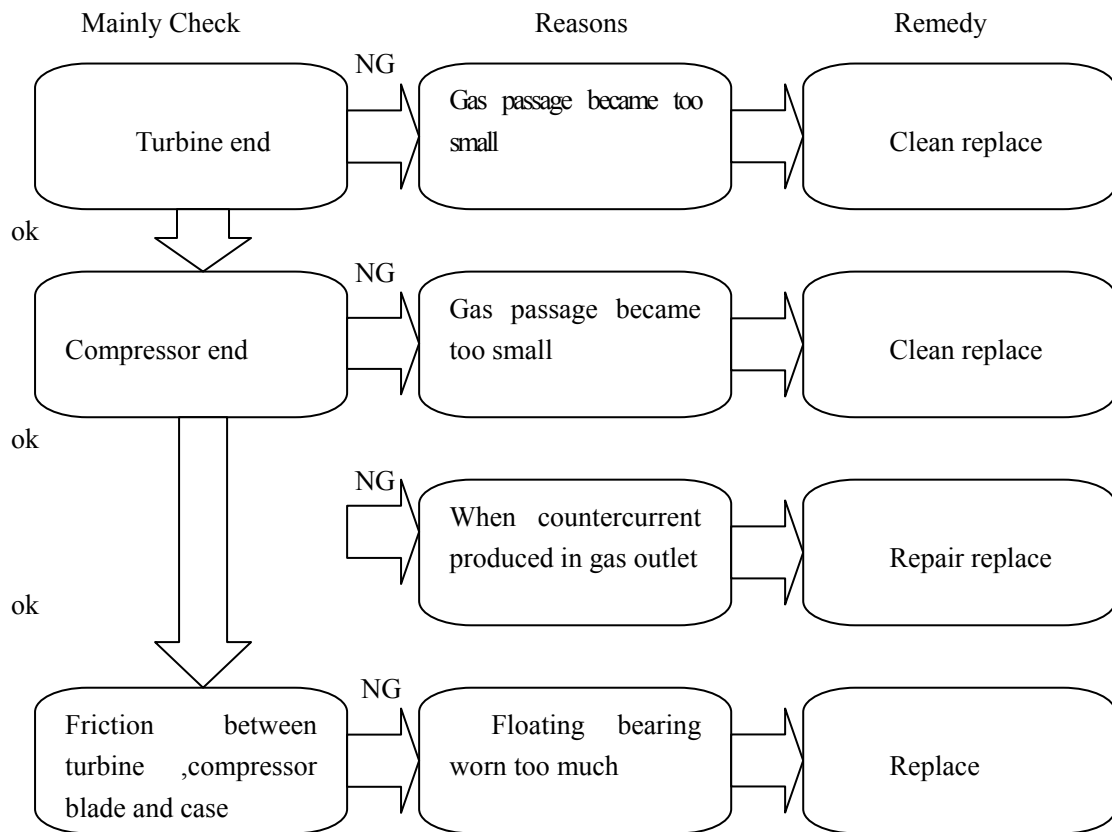

### (4) vibration

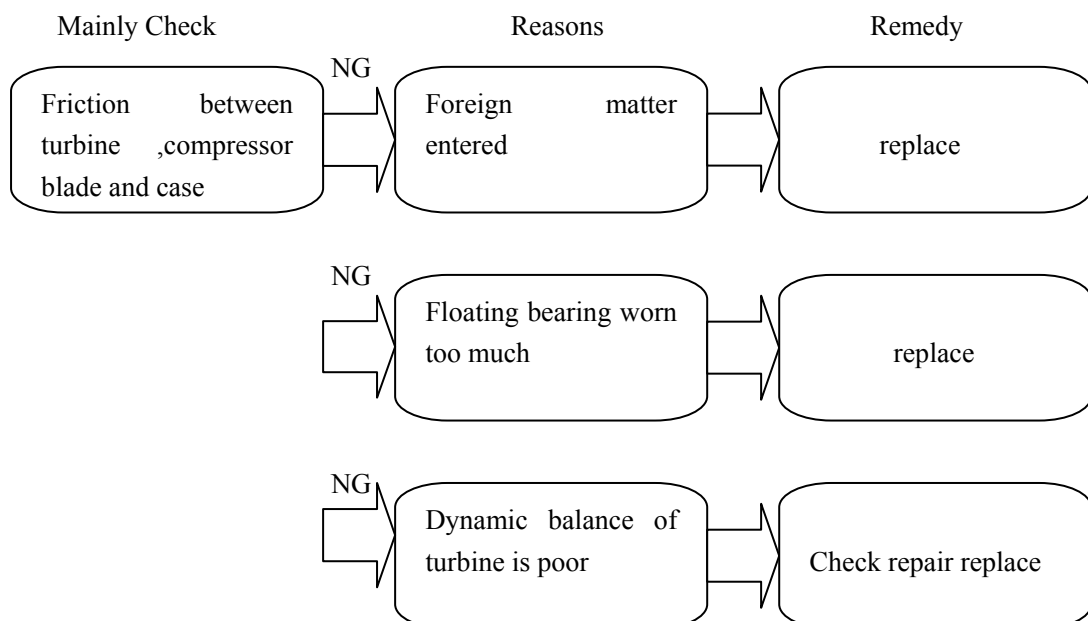

## **The chapter 6 The matching of diesel engine & automobile**

**The matching of diesel engine and vehicle is completed by the designer. But the persons for design, sale and service of diesel engine must know and grasp the knowledge, it will help to bring into play greatly the excellent performance of our diesel engine, and avoid matching incorrectly to bring performance and fame effect for our diesel engine.**

### **Arrangement of diesel engine on the vehicle**

#### **Carry cargo vehicle**

**In general, carry cargo vehicle adopted pre-engine and rear-drive, it included long-head, short-head and flat-head engine.**

**Long-head engine: Make driver's cab put the back of engine, the advantage is: the safety of the driver is good, repairing engine is convenience. The disadvantage is: Field of vision is not bad, the using space is too small, so in general, we will not adopted the arrangement on the light-duty vehicle, sometimes it will be adopted on the medium and heavy-duty vehicle.**

**Short-head is engine is: Let the middle part of the front plate of cab made concave, then make the small part of engine protrude**

concave of the front plate of cab. The arrangement may improve the disadvantage of long-head. Some light-duty and medium-duty were adopted, but in general it is not adopted on heavy-duty, because the engine of heavy-duty is too big.

**Flat-head:** Make cab put the top of the engine, as well as make engine arrange inside cab. The arrangement advantage is opposite with long-head. At present the arrangement has been used in every grades vehicle.

## **Passenger car**

There are four arrangements for engine in passenger car: Pre-engine, horizontal middle engine, rear-transverse engine, rear-vertical engine, in general adopted rear-drive.

At present the fuel passenger car only have two arrangements namely pre-engine and rear-transverse engine. In general, light passenger car adopted pre-engine and rear-wheel drive, namely engine arranged the middle of cab, the power transfer the rear wheel passing running shaft, it is similar carry cargo.

Now the big and medium duty passenger car manly rear-engine, the advantages:

① Improved the front shaft load, may realize to lengthen front-hanging, adopted the front door configuration, convenient for

vehicle arrangement, shaft load distribute reasonable, and the rigidity of the car body is big, and bear the load is good.

② The engine arranged the back of carriage, increased using rate of vehicle floor area, convenient for chair arrangement. Because there is no running shaft passing between the two shaft of the vehicle, and convenient for arrangement big luggage store under the floor, and conditioner, warm air and so on. The engine isolated carriage, so it reduced gas, noise vibration of engine to the effect of the carriage inside. Otherwise the noise vibration of transferring system transferred to vehicle is small. Of course the arrangement provided the higher requirement to the cooling and handling.

### **The bearing of engine**

No matter what pre-engine and rear-engine, the bracket of the engine is installed longeron of vehicle frame or the bracket of longeron with rubber absorber. Must note: the position and direction of bracket should make transverse swing center line of engine torsion pass center of mass of engine, and at the same time make transverse swing center line pass the first gimbal center of engine and clutch assembly, in order to make transverse swing of engine reach min. or zero.



## **Cooling of engine**

**CY diesel engine is close forced circulation water cooling. It is made up cooling sleeve, water pump, thermostat, fan and radiator. The function of cooling system is to maintain engine working at the right temperature, this includes two meanings: the one meaning is: make engine cool, don't make it overheat, the other meaning is: try to prevent engine from working at the overheat, because too cold will lead to damage for engine performance and life.**

### Upper limit design of cooling system

Cooling unit of engine, such as water pump, fan, and radiator is designed according to the cooling function, and meet the working condition requirements. For example to the carry cargo, in general the design is according to the high temperature in hot summer (40°C), vehicle full load, climbing slope, and the head-on wind speed is too small when ran.

The performance index is flow volume at a compress-head. Namely when water pump work, must make water flow at pressure, overcome flowing resistance of the complete system, flow at flowing volume, ensure diesel engine to heating of disperse cooling water can be brought in water temperature difference of permitting inlet and exhaust. Now the following formula can

express the meanings:

$$Q_w = \frac{Q_w}{\Delta t_w \cdot C_w \cdot \rho_w} \text{ (m}^3\text{/s)}$$

**V<sub>w</sub>** : The flowing volume of cooling water

**P<sub>w</sub>** : water density, kg/m<sup>3</sup>

**C<sub>w</sub>** : Specific heat of water , kJ (kg.K)

**Q<sub>w</sub>** : The heating of disperse cooling water at the unit time, kW

**Δt<sub>ww</sub>** : Inlet and exhaust port temperature rising of <sub>w</sub>circulation cooling <sub>w</sub>water, °C

In general Δt<sub>ww</sub> is 6-12°C, too big and too small is not good to the cooling water system.

Because cooling system is close forced circulation, the heating of engine disperse cooling system must disperse heat by radiator (by fan blow), make water temperature reduce again. So, for the radiator, apply the formula:

$$Q_w = V_a \cdot \Delta t_a \cdot \rho_a \cdot C_{pa} = K \cdot A \cdot \Delta t_{wa}$$

**V<sub>a</sub>** : Air flow volume of passing radiator, m<sup>3</sup>/s

**Δt<sub>wa</sub>** : The front and rear temperature rising °C

**P<sub>a</sub>** : Air density, kg/ m<sup>3</sup>

**C<sub>pa</sub>** : Specific heat of air pressure, kJ(kg.K)

**K** : Dispersion coefficient of radiator, kW(m<sup>3</sup> .K)

**A** : Dispersion area of radiator, m<sup>2</sup>

$\Delta t_{wwa}$ : The average temperature difference between water in radiator and air outside radiator °C.

There is special test and calculation for the dispersion area and dispersion coefficient of radiator, in general, it is supplied by manufacture factory, it also supplies passing air flowing volume of radiator and performance curve of resistance, it will use when choose fan ( it also has air pressure-flowing volume curve).

Dispersion heat volume  $Q_w$  that diesel engine disperse to cooling water will be tested by special heat balancing experiments, it can be evaluated according to experience formula.

Integrate above contents, we will know the total design order:

.Confirm diesel engine  $Q_w$ ,

.Choose right  $\Delta t_{ww}$ , confirm engine Max. draining water temperature limit  $t_{w2}$ , so inlet water temperature  $t_{w1}$  confirm,

.Calculating water pump  $V_w$ , confirm water pimp,

.Set  $\Delta t_{wa}$ , confirm the fan flow volume  $V_a$

.Inlet wind temperature  $t_{a1} = 40^\circ\text{C}$  ,  $t_{a2}$  confirm,  $\Delta t_{wwa}$  confirm, calculated  $K, A$ .

.Choose radiator according to speed  $K, A$ , confirm flowing volume-resistance relation:

Choose fan according to the speed, flow volume and wind pressure curve.

**If the condition permits, after designed cooling system, should do heat balance test in order to check design reasonable.**

**Pay attention to the matching between the face dimension of radiator and vane outside diameter in design.**

### **Low limit design of cooling system**

**According to the above, the main parts choice of cooling system carried out at disperse heat heavily, but practice of diesel engine (vehicle), don't need to do such as. Otherwise, when cooling start, must warm engine quickly, so when design cooling system, must consider these requirements.**

**CY Diesel engine installed thermostat of wax type, the opening temperature is 76 °C, the complete opening temperature 86 °C. The function: when engine cooling start or low temperature, and load light, as long as cooling water temperature is not over 76 °C, here the draining water of engine don't flow radiator, but directly return water pump entry, form small cycle, in this way engine warm quickly, and water temperature will not too low for a long time. When water temperature is higher 76 °C, the thermostat opens gradually, water flow to the radiator, until the water temperature reached 86 °C, the thermostat opens completely, all cooling water flows into radiator, makes big cycle.**

**On the vehicle, in order to prevent the water temperature too low of engine in winter of north, and reduce head-on wind blow to engine, some have designed window shade, reduce head-on wind by reducing and closing window shade, it also has special prevent cold sleeve, this is the same purpose.**

**Power consume of engine fan is about 5-10% of engine power, is the big part in accessory power loss. But the most time don't need to use fan during vehicle is running, the winter of north is so. Otherwise, fan is also noise sounder, it is one of the main noise source of vehicle. So if we consider it according to the save energy, reducing noise and keeping ideal heating state of engine and increasing the life of using, fan need to adopted clutch.**

**In China, all applied silicone oil clutch fan that have been manufactured at present. The characteristic is: the air temperature at the end of radiator doesn't reach the temperature (in general it is 65-70°C), the position between fan and fan pulley comes away, namely fan doesn't need run in case waste power without function. But when the air temperature is high at the end of radiator, reached setting temperature, silicone oil clutch joggle, depend on fan running to realize cooling.**

**Pay attention to the notes for the design of rear-engine cooling system**

**When engine arrange the back, because the function of head-on wind reduced greatly, engine locates again relatively to close in space, so pay attention to design of cooling system.**

**The air inlet: The air inlet of cooling for the passenger car of rear-engine should locate left-rear side of vehicle, this only considers our road status, namely the vehicle run at the right, so the right side is near road, dust is relatively big, air is dirty, it is easy to pollute radiator and so on cooling system parts.**

**Air passage: In principle air passage is not at the same side with exhaust pipe of engine, but if can't avoid, must adopt heat insulation measures. Air passage must be circle and smooth in order to reduce resistance loss, the cross section of air passage should match with the face of radiator.**

**The arrangement of radiator and fan: In order to use air passage, radiator and fan should arrange separately, it should not like pre-engine to arrange of the coaxial line with engine. Fan don't install on the engine directly, but move it out to air passage, but it still drives by engine passing belt.**

**Design and calculation: because engine locates relatively close in space, and no fan blowing, so dispersing heat for engine passing block to outside reduces, dispersing heat will increase to the cooling system, compare with pre-engine, when want to change rear-engine,**

should increase propriety fan diameter and radiator area, in case occurring engine overheat and damage.

## **Air intake of diesel engine**

Air intake of diesel engine is filtrated by the air filter, in case dirty, sundries and dust enter into cylinder and cause damage. In normal inlet air condition, element life of air filter is 200 hour in general, if air is too dirty, dust is too much, air filter will soon jam, and effect inlet air volume of engine, and cause engine working abnormal.

In general, air inlet arrange on the top of the vehicle for an advanced automobile design, lead to inlet of air filter by the pipe, so sucked the air to be cleaning, and reduced the speed of becoming dirty and jammed greatly.

Operator and maintenance person of engine especially must note: when rear-engine, air inlet arranges in the cover of engine, because it is near the ground, the front wheel agitates, and rolling and absorbing function of air when air is running, here enter air mass of engine is too bad, air filter jams quickly and even damage, and cause engine power reducing.

# **The power matching for diesel engine and vehicle**

## **Dynamic characteristics of automobile**

The dynamic characteristics of automobile is assessed by the three indexes, namely:

- (1) The max. speed of automobile  $V_{amax}$ , km/h
- (2) Accelerating time of automobile  $t$ , s.
- (3) Max. slope of climbing for automobile  $i_{max}$ , %

The max. speed of automobile is : on the level road(concrete and asphalt), the automobile can reach the Max. speed at certain load. When design the max. speed of automobile, must consider the condition of road and traffic. In general, the stipulate speed on the road has “continuous speed” and “the max. speed”. Obviously the max. vehicle speed with high dynamic performance should higher than the stipulated “the max. speed” on the road.

Accelerating capacity of automobile will affect greatly the average running speed, often use accelerating time in the original starting and accelerating time of overtaking to show the accelerating capacity of automobile. Accelerating time in the original starting is: When the automobile starts from the first grade with max. accelerating intensity (include the best changing grade time) changes the high grade gradually to reach the destining distance or the time that the automobile speed needs time. Accelerating time of overtaking



is: use the highest grade or sub-grade from a medium-speed accelerating fully to reach a high speed that the automobile speed needs time. Because when overtaking, the automobile opposes running with overtook automobile, easily cause accident, so the overtaking capacity is high, the journey of opposes running is short, the running is safe. In general the spending time (s) from 0 to a high speed shows the accelerating capacity of automobile starting in original position. The spending time (s) from the highest grade to a sub-grade from 30 km/h or 40 km/h accelerating fully to a high speed shows the accelerating capacity of automobile overtaking.

The climbing slope capacity of automobile is showed by the Max. climbing slope degree  $i_{\max}$  %with loading automobile on the good road. Obviously the Max. climbing slope degree is the I grade max. climbing slope degree. In general climbing slope degree of carrying cargo should reach 30%, namely it is about 16.5 °.

### **Affect the factors of automobile dynamic characteristics:**

#### **(1) The choice of engine**

In the final analysis, automobile is driven by engine, so the dynamic characteristics of engine will affect directly the dynamic characteristics of automobile. Correlative factor directly with the dynamic characteristics of automobile is external characteristics of

**engine. For example, Max. torque will decide max. climbing slope degree of automobile and rated power will decide the max. speed of automobile and accelerating capacity.**

**(2) The matching of rotating system**

**Efficiency of rotating system and ratio of rotating system is concerned closely with the dynamic characteristics of automobile, this will be introduced at the third part.**

**(3) Automobile outline and mass and so on factors**

**The design rationality of the automobile outline decided air resistance of automobile running. The mass of automobile itself affects directly flow resistance, accelerating resistance, climbing slope resistance. The mass itself is bigger, and resistance is bigger, the dynamic characteristics of automobile will reduce obviously. The tyre choices of automobile will affect directly rolling resistance, and it also affect the dynamic matching design. The distribution will affect adhesion force of driving wheel. If the distribution is not reasonable, adhesion force of driving wheel is not enough, in spite of it is powerful engine, it can't bring into play function.**

## **Fuel economy of automobile**

**There are many accessing measures for fuel economy of automobile, at present there are four kinds that nation stipulated:**

### **(1) Accelerating fuel consumption**

**Accelerating fuel consumption is:**

**The measured fuel consumption that the automobile with direct grade (or the highest grade) at 30km±1km/h first speed, oil throttle open completely passed 500m test road.**

### **(2) The fuel consumption of equal speed running**

**The fuel consumption curve that the automobile runs 500 m with the highest grade equal speed, the speed is from 20km/h at every 10 or 20km/h until 90% of the max. speed, at least five kinds speed measured.**

### **(3) Six working condition fuel consumption**

**The measured fuel consumption that automobile runs according to stipulated working condition and time (different automobiles is wit different working condition).**

### **(4) Average using fuel consumption at limit condition**

**The fuel consumption that automobile runs 50km road test at limit condition. In general one hundred fuel consumption is namely “ limit running fuel consumption”**

**The factors of affecting automobile fuel economy are divided into**

**configuration design and usage. The affecting factor of configuration design is the same with the dynamic effecting factors:**

**(1) Engine itself**

**One is: the fuel consumption is low at full-load, the more important is medium, low fuel consumption area at all range must be broad, it is conventional for fuel economy.**

**(2) Rotating system**

**Efficiency of rotating system, grade, rotating ratio will affect each other. High efficiency of rotating system, more grades, reasonable rotating ratio can all improve fuel economy, this is the cause that neutral transmission comes into being.**

**(3) The automobile mass**

**Obviously the mass of automobile is bigger, and all kinds of resistances are bigger, so the economy is poor very much. Carrying cargo used the “mass applying coefficient”, namely “the proportion between efficiency load and mass itself “to appraise the design level of automobile mass. In general the fuel economy is one hundred kilometer using oil every ton to compare.**

**(4) Automobile outline and tyre**

**Outline design effects air resistance, obviously air resistance is bigger, so the fuel economy is poor very much. The tyre will affect rolling resistance.**

## **Concrete using of automobile will also affect fuel economy of automobile:**

### **(1) The running speed of automobile**

**Only consider from one hundred fuel consumption or ton one hundred fuel consumption, we think when the automobile runs at medium-speed, it will save oil. When it is low-speed, the load rate of engine is low, fuel consumption is high a little, but when it runs at high-speed, the air resistance increases greatly, so the fuel consumption increases quickly.**

### **(2) The choice of grades**

**At the same road and speed, using the high grade will make engine load rate higher, so it will save oil.**

**(3) Using trailer may reduce ton one hundred kilometer fuel consumption of carrying cargo.**

### **(4) Right adjustment and maintenance**

**Include tyre pressure, clutch clearance and the difference of brake clearance adjustment and so on.**

## **The matching of engine and automobile**

### **(1) The choice of engine power**

**During the design of automobile, the first ensure anticipate the**

highest speed of automobile to choose the possessing power of engine. Although the highest speed is only one of the dynamic index, but in fact it also reflects accelerating capacity and climbing slope of automobile. The automobile needs the power of engine will get from the following formula:

$$P_e = \frac{1}{\eta\tau} \left( \frac{Mfg}{3600} V_{a\max} + \frac{C_D A}{76140} V_{a\max}^3 \right) \text{ kW}$$

In formula:

**M:** The total mass of automobile, kg

**g:** Gravity acceleration,  $g=9.8 \text{ m/S}^2$

**f:** Resistance of coefficient rolling

**V<sub>a max</sub>:** The highest design speed of automobile, km/h

**C<sub>D</sub> :** The coefficient of air resistance

**A:** The head-on area of automobile,  $\text{m}^2$

**$\eta_T$ :** Coefficient of rotating system

Reference  $C_D$ ,  $f$ ,  $\eta_T$  of common automobile, and set  $M$ ,  $A$ ,  $V_{a\max}$  can calculate the power that engine needs  $P_e$ .

In engineering, often adopt automobile specific power value (namely  $P_e / M$ ) that adopts statistical every ton. The first confirm engine power according to the total mass of automobile. In general, the specific power of carrying cargo is above 8kW/t, the highest is above 30kW/t. If the highest speed of designing is higher, so the specific power should be bigger, the highest speed of modern carrying

cargo is about 100km/h, so the specific power should be about 15kW/t, and in general light-duty is bigger a little, and medium-heavy automobile is small a little.

Use the specific power of engine in the passenger car is almost same. Also the specific power of small passenger car is big a little, medium-big passenger car is small a little.

## (2) Confirming of the smallest rotating ratio

In most of time, the automobile runs at the highest speed, namely runs at the smallest rotating ratio, so it is very important to choose the smallest rotating ratio.

The total rotating ratio of rotating system  $i_1 = i_g i_0 i_e$

$i_g$ : The rotating ratio of transmission

$i_0$ : The rotating ratio of main reducer

$i_e$ : The rotating ratio of differential equipment or subsidiary transmission

Confirming principle of the smallest rotating ratio of automobile is:

$$V_p \cong V_{amx}$$

$V_p$ : At engine specific power speed, the automobile speed, km/h

$$V_p = 0.377 \frac{r_r \cdot n_e}{i_1}$$

$n_e$ : Rated speed of engine, r/min

$r_r$ : The rolling radius of wheel, m

So we know:

$$i_t = 0.377r_r \cdot n_l \cdot \frac{1}{V_p}$$

$$i_{t\min} \geq 0.377r_r \cdot n_l \cdot \frac{1}{a_{\max}}$$

The common automobile has not subsidiary transmission and differential equipment,  $i_e=1$ , if there is no overspeed grade  $i_g=1$ , so  $i_{t\min}$  is rotating ratio  $i_0$  of the main reducer, namely  $i_0 = i_{t\min}$ . If there is overspeed grade,  $i_{t\min} = i_0 \cdot i_{g\text{超}}$ . In general the smallest rotating ratio of carrying cargo  $i_{t\min}$  is 6-7.

### (3) The confirming of max. rotating ratio

When confirmed max. rotating ratio, must consider three questions: The biggest climbing slope degree, adhesion force and automobile min. steady speed.

To common automobile, the max. rotating ratio of rotating system  $i_{t\min}$  is product of the rotating ratio  $i_{g1}$  for the first grade of transmission and the rotating ratio  $i_0$  of the main reducer. When know  $i_0$ , confirm  $i_{t\min}$  namely confirm the first grade ratio  $i_{g1}$  of transmission.

The first, design it according to the max. climbing degree  $i_{t\min}$ ,

$$i_t \geq \frac{Mg\varphi_{\max} \cdot r}{T_{tq\max} \cdot \eta_T} \quad i_{g1} = i_{r\max} / i_0$$

in formula, r: the radius of wheel, m:

$T_{tq\max}$ : the max. torque of engine, N.m,



$$\varphi_{\max} = f \cdot \cos \alpha_{\max} + \sin \alpha_{\max};$$

**$\alpha_{\max}$ : Max.climbing slope angle**

**Then figure according to conditions:**

$$F_{r\max} = \frac{T_{iq\max} \cdot i_g \cdot i_0 \cdot \eta_T}{r} \leq Z_\varphi \cdot \varphi$$

**In formula:  $F_{t\max}$  : the max. driving of automobile, N,**

**$Z_\Phi$  : Normal counterforce on the driving wheel**

**$\Phi$ : Attachment coefficient of road, take 0.5-0.6,**

**If the result of calculating can't meet conditions, should change the total collocation of automobile, and increase adhesion force of driving wheel.**

**To the cross-country automobile, should still consider the min. steady speed.**

**In general the max. rotating ratio of carrying cargo is 35-50.**

**(4) Confirming of grades of rotating system & rotating ratio every grade**

**There is a certain regularity for rotating coefficient grade (advanced grade) of all kinds of automobile. In general the light-duty carrying cargo adopts four grades gear-box under 3.5t of total mass. The total mass is 3.5-10t, in general adopts five grades gear-box.**

**In general, if rotating system grades is more, it can be in favor of bring into play dynamics and economy, but if it is too more, it will**

make configuration of transmission become complexity, and it is difficult to handle it.

The rotating ratio of every grade of automobile is distributed according to grades of geometric proportion, namely  $i_{g1} / i_{g2} = i_{g2} / i_{g3} = i_{g3} / i_{g4} = \dots = q$ . But the rotating ratio of transmission can be caused by joggle of gears, because the teeth of gear must be integer, so there is departure between the rotating ratio value of every grade in practice and theoretic calculating value. Besides, if the grade is higher, the interval of the rotating ratio near two grades should reduce a little, it is convenient for improving the dynamics of automobile.