

## Introduction

**The user information supplied with each bus is intended for use only by persons who are qualified to operate the bus. The user information is split into the following parts:**

- The Driver's Operating Instructions are intended to answer all important questions concerning operation of the bus in a concise and clearly understandable manner.
- More detailed and complete information, as well as further information relevant to safety, can be found in the Operating Instructions.
- The Maintenance Record serves as a guide to the technical care of the bus. It contains all the information on maintenance intervals and maintenance tasks as well as pages for confirming that the maintenance work has been carried out.

Please consult the “Safety” section before starting up the bus for the first time, and familiarise yourself with the contents of these Operating Instructions before setting off.

Items of optional equipment are also described, if their operation needs explanation. The bus delivered to you has been customised in accordance with your order, therefore some descriptions and diagrams may differ from the equipment on your bus.

The Driver's Operating Instructions, the Operating Instructions and the Maintenance Record are important documents and must always be carried in the bus.

Our buses are the subject of ongoing development. You are therefore asked to appreciate that we reserve the right to make modifications to the design, equipment and technical features. For these reasons, no claims can be made based upon the contents of this user information.

## Environmental protection

The declared policy of EvoBus GmbH is one of integrated environmental protection. This policy starts at the root causes and encompasses in its management decisions all the consequences for the environment which could arise from production processes or the products themselves.

The objectives are for the natural resources which form the basis of our existence on this planet to be used sparingly and in a manner which takes the requirements of both nature and humanity into account.

Operate your vehicle in an environmentally responsible manner and you will help to protect the environment. Fuel consumption and wear in the drive train (engine, clutch, transmission, axles, brakes, tyres) are extremely dependent on your driving style.

We hope you enjoy driving your bus.

EvoBus GmbH

Mercedes-Benz Omnibusse

**Vehicle identification . . . . . 1**

**Safety . . . . . 3**

General safety information . . . . . 4

Fire-prevention measures . . . . . 9

Storage space for hand luggage . . . . . 9

Driver's rest area safety precautions . . . . . 10

Windscreen wiper system safety precautions . . . . . 10

Safety precautions for the air-conditioning system . . . . . 10

Operation of auxiliary heating . . . . . 11

**General . . . . . 13**

Preparation for the journey - daily tasks . . . . . 14

Preparation for the journey - weekly tasks . . . . . 15

Additional maintenance tasks dependent on bus use . . . . . 16

General bus care and maintenance . . . . . 16

Care and cleaning . . . . . 17

**Operation . . . . . 19**

Running-in guideline . . . . . 22

Starting the engine . . . . . 22

Driving . . . . . 24

Stopping the engine . . . . . 26

Towing . . . . . 26

Trailer towing . . . . . 29

Loading a trailer . . . . . 29

Driving with a trailer . . . . . 30

Ball hitch trailer coupling (fixed) (option) . . . . . 31

Ball hitch trailer coupling and open-jaw trailer coupling (detachable) (option) . . . . . 31

Connecting the power supply . . . . . 32

Trailer coupling maintenance . . . . . 32

Refuelling (diesel fuel) . . . . . 32

BlueTec® exhaust gas cleaning system . . . . . 34

AdBlue® service product . . . . . 36

Filling with AdBlue® . . . . . 37

Diesel particulate filter . . . . . 40

Diesel particulate filter regeneration . . . . . 42

Starting regeneration of the diesel particulate filter manually (parked regeneration) . . . . . 44

Function description: accident data recorder (ADR) (option) . . . . . 46

Brake system safety precautions . . . 47

Emergency braking . . . . . 47

Braking and stopping . . . . . 48

Brakes with anti-locking protection . . . . . 48

Applying the parking brake . . . . . 49

Releasing the parking brake . . . . . 50

Emergency braking in the event of failure of both brake circuits . . . . . 51

EBS brake system . . . . . 52

Acceleration skid control (ASR) . . . . 52

Brake Assist . . . . . 53

Adaptive brake lamps . . . . . 53

Electronic Stability Program (ESP) (system description) . . . . . 54

Electronic Stability Program (ESP) (function description) . . . . . 55

Deactivating acceleration skid control (ASR)/Electronic Stability Program (ESP) . . . . . 57

## Table of contents

|   |           |   |    |   |            |
|---|-----------|---|----|---|------------|
| Operating 230/400 V systems (option) . . . . .                      | 58        | Switches below the driver's window . . . . .                    | 84 | Exterior flaps on the TRAVEGO M / L . . . . .   | 100        |
| Fitting the skibox (option) . . . . .                               | 59        | Instrument cluster . . . . .                                    | 86 | Layout and function description: fire extinguishing system (option) . . . . .                                   | 101        |
| Swivelling the skibox (option) . . . . .                            | 60        | DTCO tachograph . . . . .                                       | 88 | Operating and malfunction displays: fire extinguishing system (option) . . . . .                                | 102        |
| Additional operating instructions for the skibox (option) . . . . . | 61        | Tachograph (display) . . . . .                                  | 90 |   |            |
| Note on maintenance work . . . . .                                  | 62        | Door pushbuttons in the driver's area . . . . .                 | 90 |   |            |
| Care and cleaning . . . . .   | 62        | Tools and emergency equipment . . . . .                         | 91 |   |            |
| Cleaning the headlamp plastic cover lenses . . . . .                | 64        | Location of the fire extinguishers . . . . .                    | 92 |   |            |
| Care/cleaning of light-alloy wheels . . . . .                       | 65        | Location of the first-aid kits . . . . .                        | 92 | <b>Driver's area controls . . . . .</b>   | <b>105</b> |
| Care and cleaning of covers, upholstery and ceiling . . . . .       | 66        | Tow bar location (option) . . . . .                             | 93 | Ignition lock . . . . .   | 108        |
| Care/cleaning of fabric covers . . . . .                            | 66        | Location of spare mirror (option) . . . . .                     | 93 | Adjustable steering column . . . . .  | 109        |
| Care/cleaning of micro-fibre covers . . . . .                       | 68        | Reversing aid display in the exterior mirror (option) . . . . . | 93 | Exterior lighting . . . . .   | 109        |
| Care/cleaning of leather covers . . . . .                           | 70        | Emergency hammer (option) . . . . .                             | 95 | Steering column switch for light and wiper functions . . . . .  | 112        |
|   |           | Driver's rest area . . . . .                                    | 96 | Steering column switch for transmission shift system and continuous brake (engine brake and retarder) . . . . . | 114        |
|   |           | Windscreen washer reservoir . . . . .                           | 98 | Steering wheel buttons . . . . .  | 115        |
|   |           | Seat belt reminder display . . . . .                            | 99 | Overview of steering wheel buttons and display screen . . . . .   | 116        |
|   |           |   |    | Left-hand steering wheel buttons . . . . .  | 118        |
|   |           |   |    | Right-hand steering wheel buttons . . . . .   | 120        |
| <b>At a glance . . . . .</b>  | <b>73</b> |   |    |   |            |
| Driver's area overview . . . . .                                    | 76        |   |    |   |            |
| Switches on the left section of the instrument panel . . . . .      | 77        |   |    |   |            |
| Switches on the right section of the instrument panel . . . . .     | 82        |   |    |   |            |

|  |     |  |            |   |            |
|--|-----|--|------------|---|------------|
| Display screen . . . . .   | 122 | Initiating an outgoing call using a mobile phone (option) . . . . .                        | 156        | <b>Switch descriptions . . . . .</b>  | <b>167</b> |
| Display screen (description) . . . . .   | 123 | Answering an incoming call using a mobile phone (option) . . . . .                         | 158        | Master safety switch (emergency-off switch) (national variant) . . . . .                    | 170        |
| Main menu screen display . . . . .   | 124 | Parking brake and emergency release device . . . . .                                       | 159        | Windscreen roller sunblind pushbutton . . . . .   | 171        |
| Menu structure . . . . .   | 124 | Air suspension safety precautions . . . . .  | 160        | Co-driver's roller sunblind pushbutton . . . . .  | 171        |
| Display screen menu control logic . . . . .  | 143 | Raising/lowering the bus Normal level . . . . .  | 161<br>162 | Pushbutton for windscreen heating (option)/driver's window heating+mirror heating . . . . . | 171        |
| Event notifications . . . . .  | 145 | Activating/deactivating axle load transfer for trailing axle (3-axle buses only) . . . . . | 163        | Pushbutton for upper wiper (option)/headlamp cleaning system . . . . .                      | 172        |
| Resetting the trip meter . . . . .   | 146 | Activating/deactivating the bus stop brake . . . . .                                       | 164        | Inverter (option) . . . . .   | 172        |
| Volume adjustment . . . . .  | 147 | Important information on the steering system . . . . .                                     | 165        | Kitchenette/attendant call enabling pushbutton (option) . . . . .                           | 172        |
| Radio volume adjustment . . . . .  | 147 | Turning the steering wheel when the bus is stationary . . . . .                            | 165        | Lavatory/multichannel audio system enabling switch (option) . . . . .                       | 173        |
| Adjusting the volume of the passenger-compartment on-board PA system . . . . .                   | 149 | Switching on the panorama camera (option) . . . . .  | 166        | Video system/reversing camera washer system switch (option) . . . . .                       | 173        |
| Adjusting the volume of the intercom in the driver's rest area/on-board kitchenette . . . . .    | 149 |  |            | Active Brake Assist OFF pushbutton (option) . . . . .                                       | 173        |
| Telephone volume adjustment . . . . .  | 150 |  |            | Lane assistant warning system pushbutton (option) . . . . .                                 | 174        |
| Initiating an outgoing call using the driver's rest area/kitchenette intercom (option) . . . . . | 151 |  |            |   |            |
| Initiating an outgoing call using the driver's area intercom (option) . . . . .                  | 152 |  |            |   |            |
| Answering an incoming call using the driver's area intercom (option) . . . . .                   | 154 |  |            |   |            |
| Mobile phone Bluetooth link . . . . .  | 155 |  |            |   |            |

## Table of contents

|   |     |   |     |   |     |
|---|-----|---|-----|---|-----|
| Acceleration skid control (ASR)<br>OFF/Electronic Stability Program<br>(ESP) pushbutton . . . . . | 174 | Driver's seat microphone switch<br>(option) . . . . .         | 179 | Passenger-compartment lighting<br>switch positions I+II . . . . . | 184 |
| Switch for deactivating pedal-<br>activated continuous braking . . . . .                          | 174 | Bus stop brake emergency release<br>switch (option) . . . . . | 179 | Night lighting switch . . . . .                                   | 185 |
| Axle load transfer switch (3-axle<br>buses only) . . . . .  | 175 | Door I pushbutton . . . . .                                   | 179 | ADR pushbutton (option) . . . . .                                 | 185 |
| "School bus operation" pushbutton<br>(option) . . . . .   | 175 | Door II pushbutton . . . . .                                  | 180 |   |     |
| Reverse warning signal (option)/air<br>horn ON . . . . .  | 175 | Emergency valve reset pushbutton<br>(option) . . . . .        | 180 | <b>Driver's seat/passenger<br/>seats . . . . . 187</b>            |     |
| Emergency switch for alcohol<br>interlock . . . . .   | 176 | Hazard warning lamps pushbut-<br>ton . . . . .                | 180 | Driver's seat safety precau-<br>tions . . . . .                   | 188 |
| Central locking pushbutton for the<br>left-side luggage compartment . . . . .                     | 176 | Normal level/kneeling pushbut-<br>ton . . . . .               | 181 | Grammer driver's seat control<br>elements . . . . .               | 190 |
| Central locking pushbutton for<br>the right-side luggage compart-<br>ment . . . . .               | 176 | Pushbutton for raising/lowering the<br>bus . . . . .          | 181 | ISRI 6860/875 driver's seat<br>controls (option) . . . . .        | 192 |
| Front roof hatch pushbutton - air<br>in/air out . . . . .   | 177 | Hillholder and bus stop brake . . . . .                       | 181 | Operation of the jump seat . . . . .                              | 194 |
| Rear roof hatch pushbutton - air<br>in/air out . . . . .  | 177 | Auxiliary batteries pushbutton<br>(option) . . . . .          | 182 | Adjusting a passenger seat . . . . .                              | 195 |
| Driver's power window pushbut-<br>ton . . . . .   | 178 | Steering column adjustment<br>switch . . . . .                | 183 | Removing a seat squab . . . . .                                   | 196 |
| Diesel particulate filter (DPF)<br>regeneration . . . . .   | 178 | Driver's area lighting switch . . . . .                       | 183 | Fitting a seat squab . . . . .                                    | 196 |
|   |     | Reading lamps switch . . . . .                                | 183 | Using the driver's seat belt . . . . .                            | 196 |
|   |     | Bus stop brake pushbutton (option)<br>. . . . .               | 184 | Operating the jump-seat seat<br>belt . . . . .                    | 197 |
|   |     |   |     | Passenger-compartment-seating<br>seat belt . . . . .              | 197 |
|   |     |   |     | Passenger seat service set . . . . .                              | 198 |

|  |   |  |   |
|--|---|--|---|
| <b>Transmission shift systems . . . . 201</b>  |   | Overview of variable speed limiter (Tempo-<br>set) controls . . . . . 228                  | Vehicle ahead detected . . . . . 251  |
| Transmission shift system safety precautions . . . . . 202                                   | Activating the variable speed limiter (Tempo-<br>set) . . . . . 229   | Combined drive/brake cruise control . . . . . 232  | How to respond to a distance warning . . . . . 252  |
| Operating the PSH (pneumatic shift aid) transmission shift system . . . . 202                | Overview of cruise control con-<br>trols . . . . . 234  | Activating drive/brake cruise control . . . . . 235  | Operating displays: distance cruise control . . . . . 253   |
| Transmission shift system safety precautions . . . . . 203                                   | Setting the speed tolerance in overrun mode . . . . . 238   | Distance cruise control (option) . . . 239   | Active Brake Assist (ABA) (system description) . . . . . 254  |
| Transmission shift system GO 250-8 (system description) . . . . . 204                        | Distance sensor for distance cruise control (ART) . . . . . 241   | Overview of distance cruise control (ART) controls . . . . . 242                           | Activation/deactivation of Active Brake Assist (automatic) . . . . . 255                            |
| Selector lever of GO 250-8 transmission shift system . . . . . 206                           | Function description: distance cruise control (ART) . . . . . 243   | Activating distance cruise control (ART) (option) while the bus is in motion . . . . . 245 | Deactivating Active Brake Assist (ABA) (manually) . . . . . 256                                     |
| Operating the GO 250-8 PowerShift transmission shift system . . . . . 207                    | Activating distance cruise control (ART) while the bus is station-<br>ary (only with stop-and-go assist (option)) . . . . . 248 | Setting the specified distance . . . . 250   | Sequence of events when emer-<br>gency braking initiated by Active Brake Assist (ABA) . . . . . 258 |
| Operating the GO 250-8 PowerShift failsafe mode with the steering wheel keypad . . . . . 217 |   |  | Function description: warning levels and emergency braking . . . . . 259                            |
| <b>Driving systems . . . . . 221</b>   |   |  | Operating/malfunction displays: Active Brake Assist (ABA) . . . . . 263                             |
| Driving systems (overview) . . . . . 224   |   |  | Special driving situations with dis-<br>tance cruise control/Active Brake Assist . . . . . 266      |
| Automatic speed limiter, gener-<br>al . . . . . 225  |   |  | Important information on the lane assistant warning system (option) . . . . . 270                   |
| Automatic speed limiter . . . . . 225  |   |  | Warning display if lane marking crossed . . . . . 272   |
| Variable speed limiter (Tempo-<br>set) . . . . . 226   |   |  |   |

## Table of contents

|  |            |  |            |  |            |
|--|------------|--|------------|--|------------|
| Deactivating the lane assistant warning system . . . . .                                     | 272        | Activating the auxiliary heating unit . . . . .                                | 288        | Unlocking the door circuit by key remote (option) . . . . .  | 305        |
| Attention Assist - system description . . . . .  | 273        | Programming auxiliary heating switch-on times . . . . .                        | 290        | Unlocking the luggage compartment flaps using the pushbuttons in the driver's area . . . . .                 | 305        |
| Attention Assist - function description . . . . .  | 273        | Activating a programmed auxiliary heating switch-on time . . . . .             | 292        | Locking door 1 . . . . .   | 306        |
| <hr/>  |            | Deactivating an activated switch-on time . . . . .                             | 294        | Locking (by key remote) . . . . .  | 307        |
| <b>Heating/ventilation/air-conditioning . . . . .</b>  | <b>277</b> | Programming the auxiliary heating switch-on duration . . . . .                 | 294        | Emergency operation (depressurising the doors using the emergency valves) . . . . .                          | 309        |
| Operating instructions for the air-conditioning system . . . . .                             | 278        | Switches/controllers in the driver's rest area . . . . .                       | 296        | Emergency unlocking of the luggage compartment flaps in the event of a compressed-air supply failure . . . . | 311        |
| Heating/ventilation/air-conditioning (HVAC) control panel . . . . .                          | 280        | <hr/>  |            | Emergency exit through emergency operation of the roof hatches . . . .                                       | 312        |
| Manually regulating the blower speed in the driver's area . . . . .                          | 283        | <b>Opening/locking . . . . .</b>   | <b>299</b> | <hr/>  |            |
| Preselecting the passenger-compartment temperature . . . . .                                 | 284        | Door pushbuttons in the driver's area . . . . .                                | 300        | <b>On-board kitchenette (integrated in lavatory cabin) . . . . .</b>   | <b>315</b> |
| Manually regulating the blower speed in the passenger compartment . . . . .                  | 285        | Anti-entrapment protection (reversing) in the door closing direction . . . . . | 301        | Safety precautions/general information . . . . .   | 317        |
| Activating the air-conditioning . . . .  | 286        | Protection against entrapment in the door opening direction . . . . .          | 301        | Use for the intended purpose . . . .   | 318        |
| Switching on air-recirculation mode in the driver's area and passenger compartment . . . . . | 287        | Operating/malfunction displays: doors . . . . .                                | 301        | Approved personnel . . . . .   | 318        |
| Activating the reheat function . . . .   | 288        | Unlocking the door circuit at the front right door . . . . .                   | 304        | First use of the kitchenette . . . . .   | 318        |
|  |            |  |            | Switching on the galley . . . . .  | 319        |
|  |            |  |            | Filling the fresh water tank inside the bus . . . . .  | 321        |



|  |     |  |            |  |     |
|--|-----|--|------------|--|-----|
| Filling the fresh water tank outside the bus . . . . .                 | 322 | Draining the water lines . . . . .                               | 335        | Filling the fresh water tank outside the bus . . . . . | 358 |
| Checking and cleaning the fresh water filter . . . . .                 | 322 | Draining the boiler . . . . .                                    | 336        | Checking and cleaning the fresh water filter . . . . . | 358 |
| Drawing water from the water tap . . . . .                             | 323 | Draining the siphon . . . . .                                    | 337        | Drawing water from the water tap . . . . .             | 359 |
| Switching on the sausage heater . . . . .                              | 323 | Replacing fuses . . . . .  | 337        | Switching on the boiler . . . . .                      | 360 |
| Cleaning the sausage heater . . . . .                                  | 326 | Malfunctions . . . . .   | 340        | Descaling the boiler . . . . .                         | 361 |
| Descaling the sausage heater . . . . .                                 | 326 | Using the sausage heater again after a malfunction . . . . .     | 340        | Switching on the sausage heater . . . . .              | 363 |
| Switching on the coffee machine . . . . .                              | 327 | Using the coffee machine again after a malfunction . . . . .     | 341        | Cleaning the sausage heater . . . . .                  | 366 |
| Brewing 1/2 a carafe of coffee (10 cups of coffee) . . . . .           | 327 | Using the boiler (option) again after a malfunction . . . . .    | 342        | Descaling the sausage heater . . . . .                 | 366 |
| Brewing 1 carafe of coffee (20 cups of coffee) . . . . .               | 328 | Other malfunctions . . . . .                                     | 343        | Switching on the 40-cup coffee machine . . . . .       | 367 |
| Descaling the coffee machine . . . . .                                 | 329 | Switching off the galley . . . . .                               | 344        | Brewing coffee in winter . . . . .                     | 371 |
| Dispensing cups of hot water (alternative to coffee machine) . . . . . | 330 |  |            | Cleaning the 40-cup coffee machine . . . . .           | 371 |
| Boiler (option) . . . . .  | 331 | <b>On-board kitchenette with 40-cup coffee machine . . . . .</b> | <b>347</b> | Descaling the coffee machine . . . . .                 | 372 |
| Setting the thermostat of the water heater . . . . .                   | 332 | General information . . . . .                                    | 350        | Winter operation . . . . .                             | 373 |
| Descaling the water heater boiler . . . . .                            | 333 | Instructions for operating a microwave oven . . . . .            | 351        | Draining the fresh water tank . . . . .                | 374 |
| Winter operation . . . . .   | 334 | Use for the intended purpose . . . . .                           | 353        | Draining the water lines . . . . .                     | 374 |
| Draining the fresh water tank . . . . .                                | 335 | Approved personnel . . . . .                                     | 353        | Draining the boiler . . . . .                          | 375 |
|  |     | First use of the galley . . . . .                                | 354        | Draining the 40-cup coffee machine . . . . .           | 376 |
|  |     | Switching on the kitchenette . . . . .                           | 355        | Draining the siphon . . . . .                          | 377 |
|  |     | Filling the fresh water tank inside the bus . . . . .            | 356        | Replacing fuses . . . . .                              | 377 |

## Table of contents

|  |            |  |     |  |            |
|--|------------|--|-----|--|------------|
| Malfunctions . . . . .   | 380        | Checking and cleaning the fresh water filter . . . . .       | 398 | Draining the 2-carafe filter system . . . . .                                | 415        |
| Restoring boiler operation following a malfunction . . . . .         | 380        | Drawing water from the water tap . . . . .                   | 399 | Draining the siphon . . . . .  | 416        |
| Using the sausage heater again after a malfunction . . . . .         | 382        | Switching on the boiler . . . . .                            | 400 | Replacing fuses . . . . .  | 416        |
| Using the 40-cup coffee machine again after a malfunction . . . . .  | 382        | Setting the thermostat . . . . .                             | 401 | Malfunctions . . . . .   | 419        |
| Using the 2-carafe filter system again after a malfunction . . . . . | 383        | Descaling the boiler . . . . .                               | 402 | Restoring boiler operation following a malfunction . . . . .                 | 419        |
| Other malfunctions . . . . .   | 384        | Switching on the sausage heater . . . . .                    | 404 | Using the sausage heater again after a malfunction . . . . .                 | 421        |
| Switching off the kitchenette . . . . .                              | 385        | Cleaning the sausage heater . . . . .                        | 407 | Using the 2-carafe filter system again after a malfunction . . . . .         | 421        |
|  |            | Descaling the sausage heater . . . . .                       | 407 | Other malfunctions . . . . .   | 422        |
|  |            | Switching on the 2-carafe filter system . . . . .            | 407 | Switching off the kitchenette . . . . .                                      | 423        |
|  |            | Brewing 1/2 a carafe of coffee (10 cups of coffee) . . . . . | 408 |  |            |
| <b>On-board kitchenette with 2-carafe filter system . . . . .</b>    | <b>387</b> | Brewing 1 carafe of coffee (20 cups of coffee) . . . . .     | 409 |  |            |
| General information . . . . .  | 390        | Brewing 2 carafes of coffee (40 cups of coffee) . . . . .    | 409 | <b>Lavatory . . . . .</b>  | <b>425</b> |
| Instructions for operating a microwave oven . . . . .                | 391        | Manual operation of the 2-carafe filter system . . . . .     | 410 | Enabling the lavatory . . . . .  | 426        |
| Use for the intended purpose . . . . .                               | 393        | Descaling the coffee machine . . . . .                       | 411 | Switchover between water (WC) and chemical (CC) operation (option) . . . . . | 428        |
| Approved personnel . . . . .   | 393        | Winter operation . . . . .                                   | 412 | Flushing the WC . . . . .  | 429        |
| First use of the galley . . . . .                                    | 394        | Draining the fresh water tank . . . . .                      | 413 | Drawing water at the handwash basin . . . . .                                | 430        |
| Switching on the galley . . . . .                                    | 395        | Draining the water lines . . . . .                           | 413 | Filling the soap dispenser . . . . .   | 430        |
| Filling the fresh water tank inside the bus . . . . .                | 396        | Draining the boiler . . . . .                                | 414 | Adding paper hand towels . . . . .   | 431        |
| Filling the fresh water tank outside the bus . . . . .               | 397        |  |     | Adding toilet paper . . . . .  | 431        |

|   |            |   |     |   |     |
|---|------------|---|-----|---|-----|
| Opening the basin undercabin-<br>et . . . . .                               | 431        | Fitting the drive belts (OM<br>470) . . . . .   | 455 | Removing the spare wheel from the<br>spare wheel cover . . . . .  | 479 |
| Changing waste bags . . . . .   | 432        | Removing the drive belts (OM<br>471) . . . . .  | 459 | Positioning the jack . . . . .  | 480 |
| Filling the fresh water storage<br>tank . . . . .                           | 432        | Fitting the drive belts (OM<br>471) . . . . .   | 463 | Removing the wheel trims . . . . .  | 481 |
| Emptying the fresh water storage<br>tank . . . . .                          | 433        | Checking the coolant level of the<br>engine and heating system . . . . .                  | 468 | Removing the wheels . . . . .   | 482 |
| Emptying the holding tank . . . . .   | 434        | Tyres - operating safety and<br>roadworthiness . . . . .                                  | 469 | Fitting the spare wheel . . . . .   | 487 |
| Winter operation . . . . .  | 435        | Tyre pressure . . . . .   | 470 | Fitting the wheel trims . . . . .   | 489 |
| Greasing the impeller of the CC<br>pump . . . . .                           | 436        | On-screen tyre pressure monit-<br>or . . . . .  | 470 | Inflating tyres using the tyre inflator<br>connection . . . . .   | 490 |
| <b>Practical advice . . . . .</b>   | <b>437</b> | Tyre tread . . . . .  | 472 | Pneumatic system test ports under<br>the driver's area . . . . .  | 492 |
| Overview of the operating, function<br>and malfunction display screen . . . | 442        | Tyre condition . . . . .  | 472 | Pneumatic test ports behind door<br>2 . . . . .   | 494 |
| Electric fuel pump (option) . . . . .                                       | 448        | Tyre age . . . . .  | 472 | Other pneumatic test ports . . . . .  | 496 |
| Engine oil level display . . . . .  | 448        | Invisible tyre damage . . . . .   | 473 | Charging the compressed-air<br>system of another bus . . . . .  | 497 |
| Oil level alerts . . . . .  | 449        | Tyre load capacity, top speed of<br>tyres and types of tyres . . . . .                    | 473 | Operating the bus stop brake<br>emergency release switch . . . . .  | 499 |
| Oil level information . . . . .   | 450        | Retreaded tyres . . . . .   | 474 | Electrical system safety precau-<br>tions . . . . .   | 499 |
| Checking the engine oil level with<br>the dipstick (option) . . . . .       | 452        | Tyre pressures table 295/80 R<br>22.5 . . . . .   | 476 | Safety precautions for handling<br>batteries . . . . .  | 500 |
| Safety precautions for work carried<br>out in the engine compartment . . .  | 453        | Safety measures to be taken in<br>the event of a flat tyre or a wheel<br>change . . . . . | 477 | Measures required for the pre-<br>vention of damage to buses or<br>components during electric welding<br>work . . . . . | 501 |
| Removing the drive belts (OM<br>470) . . . . .                              | 453        | Fitting snow chains . . . . .   | 478 |   |     |

## Table of contents

|  |     |  |     |                                      |            |
|--|-----|--|-----|--------------------------------------|------------|
| Electrical system (illustration shows TRAVEGO 2-axle model as an example) . . . . .                  | 504 | Fuse assignment for roof-mounted heating, ventilation and air-conditioning system (Spheros) . . .          | 532 | <b>Technical data</b> . . . . .      | <b>559</b> |
| Battery isolating switch (with switch-off authorisation LED) . . . . .                               | 506 | Handling fuses . . . . .   | 533 | Vehicle data . . . . .               | 560        |
| Driver's area interior switch panel . . . . .  | 508 | Disconnecting vehicle batteries . . .  | 534 | Overview of lighting types . . . . . | 561        |
| Main switch panel (under the driver's area) . . . . .  | 510 | Recharging vehicle batteries . . . . .   | 536 |                                      |            |
| Auxiliary switch panel . . . . .   | 512 | Switching to the auxiliary batteries (starter batteries) (option) . . . . .                                | 537 | <b>Index</b> . . . . .               | <b>563</b> |
| Ceiling switch panel . . . . .   | 514 | Notes on jump-starting . . . . .   | 537 |                                      |            |
| Electrical connection for the roof-mounted system (heating, ventilation, air-conditioning) . . . . . | 516 | Jump-start procedure . . . . .   | 538 |                                      |            |
| Battery compartment . . . . .  | 518 | Activation and evaluation of the Integrated Diagnostics System (IDS) . . . . .                             | 539 |                                      |            |
| Notes on fuse assignments . . . . .  | 519 | Changing bulbs . . . . .   | 542 |                                      |            |
| Fuse assignment for driver's area interior switch panel . . . . .                                    | 520 | Adjusting the headlamps for driving on the left or right (only in buses with bi-xenon headlamps) . . . . . | 547 |                                      |            |
| Fuse assignment for main switch panel (under the driver's area) . . . . .                            | 522 | Removing the exterior mirror, fitting the emergency mirror (option) . . . . .                              | 548 |                                      |            |
| Fuse assignment for auxiliary switch panel . . . . .   | 524 | Maintenance tasks for the air-conditioning system in the bus (filter maintenance) . . . . .                | 550 |                                      |            |
| Power distribution board (PDB) fuse assignment on auxiliary switch panel . . . . .                   | 528 | Scopes of maintenance for the air-conditioning system . . . . .  | 551 |                                      |            |
| Fuse assignment for ceiling switch panel . . . . .   | 530 | Bleeding the coolant circuit for the heating system . . . . .  | 555 |                                      |            |



M00\_00-0316-01

The vehicle identification plate bearing the vehicle identification number (VIN) and information regarding permissible weights is located on the right-hand side in the front doorway



**Note:**

Precise vehicle identification is a prerequisite to exact and correct assignment of “vehicle data”. You will also need the VIN when ordering replacement parts and making technical enquiries.



M00\_00-0315-01

| No. | Designation                         | Value |
|-----|-------------------------------------|-------|
| 1   | Vehicle designation                 |       |
| 2   | Headlamp basic setting              |       |
| 3   | Headlamp basic setting              |       |
| 4   | Vehicle Identification Number (VIN) |       |
| 5   | Permissible gross vehicle weight    |       |

| No. | Designation                             | Value |
|-----|---|-------|
| 6   | Permissible axle load for front axle    |       |
| 7   | Permissible axle load for driven axle   |       |
| 8   | Permissible axle load for trailing axle |       |

**Decoding the vehicle identification number (VIN) using WEB 632430 13 (xxxxxx) as an example:**

| WEB    | World-wide manufacturer code     |
|--------|----------------------------------|
| WEB    | EvoBus Germany                   |
| NMB    | MB Turkey                        |
| 6324xx | Vehicle model designation number |
| 632430 | Travego 16 RHD (Euro 6)          |

## 30 Vehicle length

|    |                            |
|----|----------------------------|
| 00 | Travego 15 RHD<br>(Euro 6) |
| 30 | Travego 16 RHD<br>(Euro 6) |
| 50 | Travego 17 RHD<br>(Euro 6) |

## 1 Steering

|   |                             |
|---|-----------------------------|
| 1 | Left-hand-drive<br>vehicle  |
| 2 | Right-hand-drive<br>vehicle |

## 3 Body type

|   |              |
|---|--------------|
| 3 | Complete bus |
|---|--------------|

## xxxxxx Sequential number



M00\_00-0573-71

Vehicle identification number (1) is also marked on the skeleton in the front right doorway. It can be accessed by opening the cover on the windscreen washer fluid reservoir (quick-release locks).

|   |           |
|---|-----------|
| <b>General safety information</b> .....                         | <b>4</b>  |
| <b>Fire-prevention measures</b> .....                           | <b>9</b>  |
| <b>Storage space for hand luggage</b> .....                     | <b>9</b>  |
| <b>Driver's rest area safety precautions</b> .....              | <b>10</b> |
| <b>Windscreen wiper system safety precautions</b> .....         | <b>10</b> |
| <b>Safety precautions for the air-conditioning system</b> ..... | <b>10</b> |
| <b>Operation of auxiliary heating</b> .....                     | <b>11</b> |

## General safety information

### General safety information

#### The use of symbols and their meanings

Safety precautions and other important information are highlighted by symbols.

In addition to the instructions provided herein, all generally applicable safety and accident prevention regulations must also be observed, e.g. in Germany, the rules and regulations of the institutions for statutory accident insurance and prevention.

Instructions and information printed on the packaging for components, tools and service products must also be observed.

Where information and instructions are to be observed, it is assumed that the user information is intended for persons who are suitably qualified to carry out the tasks by nature of their education, training and experience.

These persons should, at the same time, be able to identify risks that may arise in the undertaking of their tasks and take the necessary measures to avoid them.

Meaning of symbols:



#### Note:

Notes about important additional information



#### Caution:

Warning notes about damage that may occur in the event of non-compliance



#### Danger.

Warning notes for risks to persons



#### Environmental protection

Notes about environmental protection measures

▷ Reference to more detailed and additional user information

### Notes on vehicle safety

We recommend that you:

- Use only genuine parts that are OMNIplus quality tested and conversion parts and accessories that have been expressly approved by EvoBus for the bus model concerned in order to rule out the possibility of jeopardising road safety and invalidating the warranty and general operating permit. These parts have been specially tested for their safety, reliability and suitability.

You can obtain further information from any OMNIplus Service Partner.

### Operating safety

Important information:

- Any work or modifications that have been carried out incorrectly on the bus may result in malfunctions.
- Tampering with electronic components and their software may cause malfunctions. As electronic components are networked, these malfunc-



- tions may also cause other, indirectly related systems to malfunction. These malfunctions may jeopardise the operating safety and reliability of the bus.
- Retrofitted electrical or electronic devices must possess type-approval complying with Directive 95/54/EC or ECE Directive 10/02.
  - Materials that are fitted in the bus during the course of installation, conversion or modification work and that are subject to mandatory fire-testing requirements must satisfy the requirements of EU Directive 95/28/EC.
  - Materials and components of seats and seat fixtures that are also fitted in the bus during the course of installation, conversion or modification work must satisfy the requirements of the following directives: 76/115/EEC as amended by 96/38/EC, 74/408/EEC as amended by 96/37/EC, 77/541/EEC as amended by 96/36/EC.
  - At the time of purchase or installation, it must be checked that these materials and components have been certified accordingly. The use of materials or components that have not been granted the relevant certificate may result in the operating permit being invalidated.
  - We recommend that you have work or modifications carried out by an OMNIplus Service Partner.

#### EU Directive 2001/85

Registration as class 1: city bus

- Vehicles constructed with areas for standing passengers, to allow frequent passenger movement.

Registration as class 2: interurban bus

- Principally for the carriage of seated passengers. Designed to allow the carriage of standing passengers in the gangway and/or in an area which does not exceed the space provided for two double seats.

Registration as class 3: tourist coach

- Exclusively for the carriage of seated passengers.

Important information for buses classified in accordance with EU Directive 2001/85 into class 2 and 3 (mixed approval):



#### Note:

The operator of the bus is responsible for ensuring that the bus is restored to the condition consistent with the permissible type of operation of the class concerned.



#### Note:

For instance, this means that, in the case of a bus being used in accordance with class 2, it is necessary to ensure that the bus is operated with seating having no aisle-side sideways adjustment.

## General safety information

### Navigation and global positioning system

If your bus is equipped with a navigation system, please observe the following instructions and information:



#### **Danger.**

Please devote your attention primarily to road and traffic conditions. Do not attempt to operate the navigation and positioning system unless the bus is stationary. Please bear in mind that your bus will cover a distance of 14 metres every second at a speed of only 50 km/h. The navigation system is unable to take into consideration the maximum load-bearing capacity of bridges or the required headroom clearance for underpasses. The driver is responsible for checking the load-bearing capacity of bridges and headroom clearances encountered en route.

### Operation of radio and mobile communications equipment

(e.g. telephone, two-way radio, fax machine, etc.)



#### **Danger.**

Please devote your attention primarily to road and traffic conditions. Do not operate the display unit, radio or mobile communications equipment unless the traffic situation permits this to be done safely. Please bear in mind that your bus will cover a distance of 14 metres every second at a speed of only 50 km/h.



#### **Danger.**

Please observe local legal requirements governing the use of mobile phones or on-board telephones/intercoms in force in the country of vehicle operation.

### Operation of mobile phones and two-way radios without an exterior aerial

We advise against making or receiving telephone calls in buses not equipped with an exterior aerial as the operation of radio transmitters, which include but are not limited to radio telephones (mobile phones), may cause inadequately

shielded equipment (cardiac pacemakers included) to malfunction.



#### **Note:**

If a mobile phone, radio system or fax machine is retrofitted in the bus in a manner that does not comply with EvoBus installation specifications, the operating permit for the bus could be invalidated (EU Directive 95/54/EC).



#### **Note:**

Older peripherals (e.g. ticket-printing machines, ticket-cancelling machines, destination displays, etc.) that are still used in new buses must comply with the technical requirements of EC Directive 72/245 EEC.



#### **Danger.**

Please observe local legal requirements governing the use of mobile phones or on-board telephones/intercoms in force in the country of vehicle operation.

### Stickers

There are various warning stickers affixed to your bus. These are intended to make you and others aware of various dangers. Therefore, do not remove any warning stickers unless it is expressly stated on the sticker that you may do so.



#### **Danger.**

If you remove warning stickers, this could result in you or other persons failing to recognise dangers. You or others could be injured as a result.

### Saved data in vehicle

A large number of electronic components of your vehicle contain data memories. These data memories save temporary or permanent technical information on

- Vehicle condition
- Events
- Fault

This technical information generally documents the condition of a component, a module, a system or the environment. These are, for example:

- Operating modes of system components. These include, for example, fill levels.
- Status messages of the vehicle and of its individual components. These include, for example, wheel speed/speed, movement deceleration, lateral acceleration, throttle pedal position.
- Malfunctions and defects in important system components. These include, for example, light, brakes.
- Reactions and operating modes of the vehicle in special driving situations. These include, for example, triggering of an airbag and use of the stability control systems.
- Environmental conditions. These include, for example, the outside temperature.

The data are exclusively of a technical nature and can be used to

- to support the detection and elimination of errors and defects,
- to analyse vehicle functions, e.g. following an accident,
- to optimise vehicle functions.

Movement profiles over distances driven cannot be put together from these data. If you make use of services, they can read technical information out of the event and error data memories.

Services are, for example

- Repair services
- Service processes
- Warranty cases
- Quality assurance

Reading out is carried out by employees of the service network (including manufacturers) using special diagnostic devices. You can obtain additional information there if necessary. Following troubleshooting, the information in the fault memory is deleted or continu-

## General safety information

ally overwritten. When using the vehicle, situations are imaginable in which these technical data in conjunction with other information could be linked to individual persons - if necessary with the assistance of an expert.

Examples of this include:

- Accident reports
- Damage to the vehicle
- Testimonies of witnesses

Other additional functions which are agreed upon contractually with the customer also permit the transmission of certain vehicle data from the vehicle.

These include, for example, the

- Telematic System Fleetboard

### Washing the outside of the bus in an automatic vehicle wash

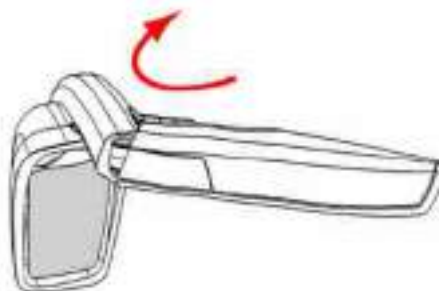

M88\_00-0004-01

Before the bus is washed, make sure that the roof hatches, driver's window and the doors are closed. Set the heating/ventilation/air-conditioning system to air-recirculation mode (Smog button). Before the bus is washed, fold both integral mirrors inwards towards the windscreen by means of the hinge pin on the mirror arm.

After the washing process, fold the integral mirrors outwards again.

Remove any attachment parts that may be fitted (e.g. satellite receiver on the roof) before the bus is washed.

Fire-prevention measures

Pre-drive measures

- Check tyre pressures (daily visual check/weekly measurement)
- Check that twin tyres are spaced sufficiently apart

On-road measures

- Monitor coolant temperature

Post-drive measures

- Inform a mechanic/next driver about malfunction, if applicable

Parking the vehicle

- Switch the battery isolating switch to OFF.



**Danger.**

Risk of fire and burns. There is a risk of fires and burns due to the high exhaust temperatures and the hot exhaust pipe for the auxiliary heating. For this reason, do not stop or park the bus over ignitable materials (e.g. grass) when the auxiliary heating is in operation, has recently been in operation or has been operated by the instant heating button/preset timer.



**Danger.**

Risk of fire and burns. Regeneration of the diesel particulate filter is associated with very high temperatures. For this reason, before regeneration is initiated manually, make sure that there are no flammable materials near the exhaust pipe and exhaust system.

Storage space for hand luggage



T68\_00-0018-31

The storage spaces above the passenger seats are suitable for light hand luggage items only.



**Danger.**

Occupants may be injured if the bus is braked sharply, changes direction suddenly or is involved in an accident due to objects being thrown around the bus. Heavy or hard objects should therefore not be carried inside the bus without being secured.

## Driver's rest area safety precautions

### Driver's rest area safety precautions

The driver's rest area must only be used by the bus driver (second driver).

The on-board telephone may only be used by the driver in accordance with legal requirements. Observe the legal requirements of the country concerned.

### Windscreen wiper system safety precautions



M54.00-2004-71



#### **Danger.**

**RISK OF INJURY.** The battery isolating switch (01S01) must always be switched off before any work is carried out on the windscreen wiper system (wiper blade cleaning, replacement of wiper blades or wiper motor etc.).

### Safety precautions for the air-conditioning system

Air-conditioning systems that are operated with refrigerant R 134 a are labelled with appropriate stickers and/or plates on the compressor.

Never mix R 134 a refrigerant and the corresponding Triton SE 55 refrigerator oil with other products.

In accordance with current good engineering practices, it is prohibited to allow refrigerant to escape into the environment when operating, servicing or decommissioning air-conditioning systems.

Refrigerants and refrigerator oils must be disposed of or recycled separately by type and nature.

Only persons having the relevant and necessary specialist knowledge, technical equipment and official approval (by health and safety inspectorate, local authority, TÜV or equivalent) are permitted to carry out maintenance work on air-conditioning systems and take back refrigerants and oils.

## Operation of auxiliary heating

The operator must maintain a logbook auditing the consumption of refrigerant and refrigerator oils.

**Danger.**

In automatically controlled air-conditioning systems, the ventilation blowers of condenser or evaporator units may start up at any time. Therefore, always switch the ignition starter switch to OFF before any cleaning work is carried out. Do not reach into the fan blades or fan rollers. Avoid any contact with refrigerant as there is a risk of frostbite. Treat affected skin areas as for frostbite, and seek medical attention immediately. Carry out maintenance and repair tasks with the engine switched off whenever possible. Keep a safe distance from moving parts (e.g. belt drive) when the engine is running.

## Operation of auxiliary heating

**Danger.**

Risk of fire and burns. There is a risk of fires and burns due to the high exhaust temperatures and the hot exhaust pipe for the auxiliary heating. For this reason, do not stop or park the bus over ignitable materials (e.g. grass) when the auxiliary heating is in operation, has recently been in operation or has been operated by the immediate heating button/preset clock.

**Danger.**

Risk of poisoning and suffocation. The auxiliary heating must not be used in enclosed spaces such as garages or workshops due to the risk of poisoning and suffocation. It must also not be used in timer or preselection mode.

**Danger.**

Risk of explosion. The auxiliary heating must be switched off at filling stations and fuel dispensing systems due to the risk of explosion.

**Danger.**

Risk of fire. The auxiliary heating must remain switched off in places where ignitable vapours or dust can accumulate (e.g. in the vicinity of filling stations, fuel, coal, sawdust and grain stores or similar).





**Preparation for the journey - daily tasks** ..... 14

**Preparation for the journey - weekly tasks** ..... 15

**Additional maintenance tasks dependent on bus use** ..... 16

**General bus care and maintenance** ..... 16

**Care and cleaning** ..... 17

## Preparation for the journey - daily tasks

### Preparation for the journey - daily tasks

- ▶ Check the windscreen washer fluid level and test the windscreen washer system and windscreen wipers.
- ▶ Check the fuel level for the engine and water heater.



**Danger.**

Switch off the engine and auxiliary heating before refuelling.

- ▶ Check the AdBlue® additive level in the BlueTec® exhaust gas cleaning system.
- ▶ Check the electrical system, paying particular attention to the headlamps, turn signals, tail lamps, brake lamps and licence plate lamps.



**Note:**

Under certain weather and operating conditions, moisture may form on the inside of the headlamps and other lights when the bus is stationary. This does not indicate a fault or defect. The ventilation openings in the headlamps allow this moisture to evaporate soon after the bus has pulled away.

- ▶ Check the luggage compartment flaps for secure locking.
- ▶ Check the emergency exits.
- ▶ Insert the driver card.



**Note:**

The indicator lamp in the tachograph lights up if no driver card is inserted.

- ▶ Check that the emergency equipment is accessible and complete, e.g. first-aid kit, fire extinguisher, warning triangle, emergency hammer for side windows, jack.

- ▶ Check the position of the rear-view mirrors, clean the mirrors, test the mirror heating.
- ▶ Check tyre pressures and tyre condition (including the spare wheel). Check that the wheel nuts are firmly seated.
- ▶ It is necessary to check that wheels and their attachment parts (rim, wheel trim, wheel bolts and nuts) are undamaged and fitted correctly. Damaged parts must be exchanged.

## Preparation for the journey - weekly tasks

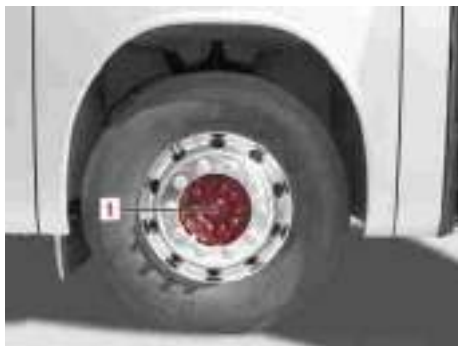

M40\_00-0115-71

- ▶ Check wheel hubs (1) on all wheels for leaks inside and out (visual check).

**Note:**

If the wheel hubs are leaking, there may be grease or oil residue on the tyres themselves or deposits on the parking area on which the bus is standing. Consult an OMNIplus Service Partner in the event of a leak.

**Preparation for the journey - weekly tasks**

- ▶ Check the coolant level in the cooling system and top it up if necessary. Check the corrosion inhibitor/anti-freeze concentration each time the coolant has been topped up and correct if necessary.

**Note:**

- Refer to the “Practical advice” section of the Operating Instructions (Checking the coolant level of the engine and heating system)

**Note:**

Refer to the Specifications for Service Products

- ▶ Check the oil level in the hydraulic steering system and top it up if necessary.

**Caution:**

If the oil level is low, have the steering system checked at an authorised specialist workshop.

- ▶ Check the belt tension of all belt drives.
- ▶ Carry out a visual check to ensure there are no leaks in the engine, transmission, driven axle, steering or the cooling and heating systems.
- ▶ Check the acid level in the starter batteries (applicable only to buses with lead-acid batteries).

**Danger.**

Observe the safety precautions in the “Practical advice” section.

### Additional maintenance tasks dependent on bus use

- ▶ Check the seat belts (belt arrester). Check the belt straps for damage (visual check).

#### Additional maintenance tasks dependent on bus use

- ▶ The bus operator must plan further maintenance tasks for the heating/ventilation/air-conditioning system (driver's area and passenger compartment) in addition to those indicated in the Maintenance Record.



#### Note:

Refer to the "Practical advice" section.

#### General bus care and maintenance

- ▶ Carry out the work specified in the Maintenance Record



#### Caution:

Regular maintenance of the chassis and drive train is essential to maintaining the operating safety and roadworthiness of the bus. The time intervals and the scope of work required are specified in the Maintenance Record supplied with the bus.



#### Caution:

It is strongly recommended that the specified maintenance intervals be observed.

**Note:**

Warranty claims based on our terms and conditions of sale and delivery may be rejected if the periodic maintenance tasks have not been carried out at the specified distances (odometer readings) or times. Have confirmation of the completed work recorded in the Maintenance Record by an OMNIplus Service Partner.

**Care and cleaning**

- ▷ You will find additional instructions for and notes on vehicle care and cleaning in the “Operation” section

**Note:**

The following stipulations for exterior cleaning must be observed: Use a sufficient amount of fresh water. Dry rubbing between washing brushes and the vehicle must not be allowed to occur. Preclean heavily soiled components. The polishing of lighting equipment with commercially available care products is not permitted. The use of polyethylene fibres as a brush material is not permitted. Recommendation: Use brushes made with textile fibres or foam.



**Running-in guideline** ..... 22

**Starting the engine** ..... 22

**Driving** ..... 24

**Stopping the engine** ..... 26

**Towing** ..... 26

**Trailer towing** ..... 29

**Loading a trailer** ..... 29

**Driving with a trailer** ..... 30

**Ball hitch trailer coupling (fixed) (option)** ..... 31

**Ball hitch trailer coupling and open-jaw trailer coupling (detachable) (option)** ..... 31

**Connecting the power supply** ..... 32

**Trailer coupling maintenance** ..... 32

**Refuelling (diesel fuel)** ..... 32

**BlueTec® exhaust gas cleaning system** ..... 34

**AdBlue® service product** ..... 36

**Filling with AdBlue®** ..... 37

## Table of contents

|  |           |
|--|-----------|
| <b>Diesel particulate filter</b> .....   | <b>40</b> |
| <b>Diesel particulate filter regeneration</b> .....  | <b>42</b> |
| <b>Starting regeneration of the diesel particulate filter manually (parked regeneration)</b> ..... | <b>44</b> |
| <b>Function description: accident data recorder (ADR) (option)</b> .....                           | <b>46</b> |
| <b>Brake system safety precautions</b> .....   | <b>47</b> |
| <b>Emergency braking</b> .....   | <b>47</b> |
| <b>Braking and stopping</b> .....  | <b>48</b> |
| <b>Brakes with anti-locking protection</b> .....   | <b>48</b> |
| <b>Applying the parking brake</b> .....  | <b>49</b> |
| <b>Releasing the parking brake</b> .....   | <b>50</b> |
| <b>Emergency braking in the event of failure of both brake circuits</b> .....                      | <b>51</b> |
| <b>EBS brake system</b> .....  | <b>52</b> |
| <b>Acceleration skid control (ASR)</b> .....   | <b>52</b> |
| <b>Brake Assist</b> .....  | <b>53</b> |
| <b>Adaptive brake lamps</b> .....  | <b>53</b> |
| <b>Electronic Stability Program (ESP) (system description)</b> .....                               | <b>54</b> |



**Electronic Stability Program (ESP) (function description) ..... 55**

**Deactivating acceleration skid control (ASR)/Electronic Stability Program (ESP) ..... 57**

**Operating 230/400 V systems (option) ..... 58**

**Fitting the skibox (option) ..... 59**

**Swivelling the skibox (option) ..... 60**

**Additional operating instructions for the skibox (option) ..... 61**

**Note on maintenance work ..... 62**

**Care and cleaning ..... 62**

**Cleaning the headlamp plastic cover lenses ..... 64**

**Care/cleaning of light-alloy wheels ..... 65**

**Care and cleaning of covers, upholstery and ceiling ..... 66**

**Care/cleaning of fabric covers ..... 66**

**Care/cleaning of micro-fibre covers ..... 68**

**Care/cleaning of leather covers ..... 70**

## Running-in guideline

### Running-in guideline

- ▶ Running in the chassis and drive train



#### Note:

The way in which the chassis and drive train of the new bus are treated during the first 3,000 miles (5,000 km) is critical to the bus' future performance and service life.



#### Note:

The load to which the bus is subjected during this period should be increased only gradually. The maintenance and lubrication tasks specified in the Maintenance Record should be carried out conscientiously.



#### Caution:

Do not place the engine under full load during the running-in period. Up to 1,200 miles (2,000 km): run in with care. Drive at no higher than 3/4 of the maximum rpm in each gear. After 1,200 miles (2,000 km): slowly increase to the

economic rpm in each gear. During the running-in period, do not drive the bus for long distances at the same road speed = same rpm. Varying engine speeds and therefore varying loads demanded of the entire drive train are favourable to the running-in of the bus.

### Starting the engine

- ▶ The parking brake must be applied. Transmission in neutral.



#### Note:

At outside temperatures of below -20 °C, preheat the engine with the water heater (refer to “Heating/ventilation/air-conditioning control panel”).



#### Note:

The bus is equipped with an immobiliser as standard. The engine cannot be started without one of the authorised keys.



#### Note:

To obtain electronic start authorisation in buses equipped with an alcohol interlock, the operating instructions supplied by the device manufacturer and the information shown on its display screen should be observed. In the driver's area there is an emergency switch with tamper-evident seal. This switch is intended to be pressed in an emergency. 22 TopClass



M54.00-1840-71

- ▶ Insert key (3) into slot (2). Press start/stop button (1) in as far as the first pressure point (ignition ON). Wait for the indicator lamp check to finish and for the gauge needles to stop moving and then press start/stop button (1) in fully and release it. Do not depress the accelerator pedal when doing so. The engine starts. If an invalid key is used, the on-board computer shows an event window (immobiliser). Use another authorised key.



### Note:

For emergencies, we recommend that you always carry a spare key to which you have access at all times.

If the engine does not start: Press and hold the start/stop button in as far as the stop. A starting attempt takes place uninterrupted for approximately 40 seconds.



### Note:

After a maximum of 3 starting attempts, wait (about 3 minutes) before trying again.

- ▶ Release the Start pushbutton when the engine starts.



### Caution:

If the “Oil pressure too low” symbol appears, switch off the engine immediately and determine the cause.



- ▶ Observe the screen display: If fault alerts appear, determine the cause and rectify it.



### Danger.

If there is insufficient pressure in the compressed-air supply system (supply pressure operating displays remain on the screen), the corresponding bar turns red until the required pressure has been reached. Do not release the parking brake until there is sufficient operating pressure (bar turns white).

## Driving

### Driving



#### Environmental protection

Never warm up the engine by allowing it to idle with the bus stationary. Instead, drive off and operate the engine at moderate engine speeds.



#### Note:

The engine should not be placed under full load until it has reached normal operating temperature (75 °C - 90 °C depending on operating conditions and the outside temperature).



#### Danger.

All doors must be unlocked before the bus is driven off.



#### Danger.

The freedom of movement of the pedals must not be restricted. The operating safety and roadworthiness of the bus would otherwise be at risk. Objects could fall and get caught between the pedals if you were to accelerate or brake suddenly, with the result that you would no longer be able to brake, depress the clutch pedal or accelerate. You could cause an accident and endanger yourself and others.

- ▶ Check the freedom of movement of the pedals.



#### Danger.

Where floor mats and carpets are fitted, make sure that these are safely secured against slipping and that the pedals have sufficient clearance.



#### Danger.

Do not stow any objects in the driver's footwell.



#### Danger.

Stow and secure all loose objects in such a way that they cannot get into the driver's footwell when the bus is in motion.

- ▶ Perform a brake test.



#### Danger.

Test the service brake immediately after pulling away.

- ▶ Keep an eye on the rev counter while driving.

**Note:**

Keep within the economical operating range. Make sure that the engine speed does not enter the danger zone (red zone).

- ▶ Notes for buses with GO 250 -8 transmission:

**Danger.**

The bus is equipped with a creep function. When the service brake is released with the creep function activated, the bus will creep forwards independently with the engine continuing to run at idling speed. If the engine speed drops below approximately 550 rpm due to increased driving resistance and/or you operate the service brake at a low engine speed, the electronics will disengage the clutch automatically. This would interrupt the flow of tractive power and the vehicle could begin to roll back, e.g. on an uphill gradient.

**Note:**

For as long as both the accelerator pedal and the brake pedal remain fully released, the clutch will stay closed and the vehicle will creep at idling speed. This works in the 1st and 2nd gears.

**Caution:**

The least wearing on the clutch is idle creeping. In stop-start traffic, therefore, the brake pedal should be used as sparingly as possible (under consideration of the road and traffic situation) so that the vehicle always creeps at idling speed. To keep the driving speed as low as possible, it is possible to shift manually into 1st gear. If the speed of the bus is kept low by means of the brake pedal, the clutch will start to slip. This would result in increased clutch wear. If the brake pedal is depressed rather more forcefully (more than 10% brake pedal travel), the clutch will open so far that it no longer slips.

**Note:**

In the event of increased loading on the clutch, an alert (grey) will appear on the display screen. If the load persists, a warning alert (yellow) will appear and the creep function will be deactivated automatically. This is designed to rule out an overloading of the clutch by the creep function.

## Stopping the engine

### Stopping the engine



M54.00-1840-71

- ▶ Stop the bus - Shift the transmission into neutral - Apply the parking brake. Press start/stop button (1) in as far as the stop.



#### **Danger.**

There is a risk of fire and burns due to the high exhaust temperatures and the hot exhaust pipe for the auxiliary heating. For this reason, avoid parking the bus where ignitable material (e.g. dry grass, leaves, etc.) is in close proximity to the exhaust system, engine and auxiliary heating exhaust system.



#### **Caution:**

To avoid engine damage, do not under any circumstances switch the engine off immediately after a long period of driving under full load (elevated coolant temperature, e.g. after hill climbing). Leave the engine running at idling speed for approximately 1 to 2 minutes to allow the exhaust gas turbocharger to cool down.

### Towing



#### **Danger.**

Only authorised specialists (recovery services) are permitted to tow away broken-down buses. The rules and regulations in the country concerned must be observed.



#### **Danger.**

In buses with the Electronic Stability Program (ESP), this function must be deactivated without exception - refer to the "Operation" section.



#### **Caution:**

Special measures are required in order to protect the transmission if the bus is to be towed: For safety reasons the propeller shaft must always be removed. The propeller shaft securing screws at the axle flange must be removed and those at the transmission flange secured against displacement.



M00\_00-0358-71

- Front/rear towing hitch:

**Note:**

To tow the bus, there are some towing jaws in the vehicle tool kit that have to be screwed into locating bore (1) provided behind the front flap or in the rear member.

**Caution:**

If the bus needs to be charged with compressed air, the supply pressure of the external source of compressed air must be no less than 11 bar. Only then will all pressure circuits be charged.

**Caution:**

Do not charge in excess of 12.5 bar. Components of the compressed-air system could otherwise be damaged.

**Note:**

For notes on charging the compressed-air system of a bus to be towed, refer to the "Practical advice" section.



M00\_00-0358-71

- Screw the towing coupling into locating bore (1).

## Towing

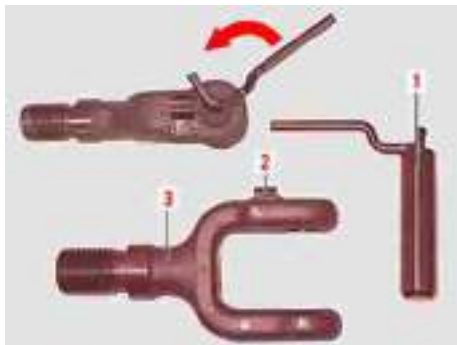

M00\_00-0340-71

- ▶ Insert the rigid tow bar into towing coupling (3) and secure with the linchpin. Turn linchpin (1) towards the rear until it engages in lock (2).

**i** **Note:**

Linchpin (1) must always remain engaged in lock (2) when the bus is being towed.

- ▶ Removal of the rigid tow bar in reverse order

**i** **Note:**

Pull lock (2) up slightly in order to disengage linchpin (1) towards the front.

- ▶ Towing with the front axle

**!** **Danger.**

The ignition starter switch must not be switched to position 2 while the front axle is raised. The wheels on the driven axle may lock. Failure to comply could result in brake intervention by the ABS/ASR system, which could cause the rear axle to skid.

- ▶ During towing, the following information must be observed.



**Caution:**

There is a risk of damage to the left-hand exterior mirror caused by the towing vehicle as the bus is being towed through tight left-hand bends. There is a risk of damage to the bus caused by the tow bar as the bus is being towed through tight right-hand bends. Observe the information/instructions on the sticker on the tow bar.



## Trailer towing

**Danger.**

Proceed with utmost care and caution when hitching up the trailer. Make sure that no persons are present between the trailer and vehicle as the vehicle is being reversed into engagement with the trailer. The overrun brake of a trailer can rebound uncontrollably when in overrun mode. To reduce the risk of serious injuries, do not uncouple any trailer that has an overrun brake if the trailer has overrun and the overrun brake is applied. A trailer that has been coupled to the towing vehicle incorrectly could break away. A correctly coupled trailer must stand horizontal behind the vehicle. Use a trailer with a height-adjustable drawbar if necessary. The maximum permissible noseweight and rear axle load of the bus must not be exceeded.

**Note:**

Observe the operating instructions issued by the trailer manufacturer.

**Note:**

If the trailer coupling is a detachable coupling, the operating instructions issued by the trailer coupling manufacturer must be observed.

**Note:**

It is prohibited to couple a turntable trailer, any trailer equipped with ESP or any trailer having a permissible gross weight of over 3.5 t.

**Note:**

The maximum permissible noseweight is 250 kg.

## Loading a trailer

Observe the following values when loading the trailer:

- the permissible gross weight of the trailer
- the permissible trailer load of the vehicle and the trailer tow hitch
- the permissible noseweight
- the permissible rear axle load of the towing vehicle
- the permissible gross weight of both the towing vehicle and the trailer

The definitive maximum permissible values are listed in the vehicle documents and on the identification plates of the trailer tow hitch, trailer and vehicle. If there are discrepancies between any of these sources, always consider the lowest value to be valid.

### Driving with a trailer

#### Driving with a trailer

The following changes in handling characteristics can be observed when driving with a trailer attached:

- acceleration and gradient-climbing capability are reduced
- braking distance is increased
- sensitivity to crosswinds is increased
- directional stability is adversely affected
- fuel consumption is increased

Avoid driving a vehicle/trailer combination faster than 80 km/h, even in countries where higher speeds are permitted.

Maintain a greater distance from the vehicle in front than you would when driving without a trailer.

Avoid sudden braking where possible. Brake gently at first to allow the trailer to run on and quickly increase your braking force.

If the trailer begins to swing from side to side:

- release the accelerator pedal
- do not countersteer
- brake if necessary
- do not attempt to draw the vehicle/trailer combination out by accelerating

The gradient-climbing capabilities from a standstill refer to sea level. When driving in mountainous areas, you should bear in mind that the power output of the engine and thus its gradient-climbing capability decrease with increasing altitude.

On long and steep downhill gradients, select a lower gear/shift range in good time. This makes use of the braking effect of the engine, reducing the amount of braking effort required to maintain a safe speed. The load on the brake system is therefore reduced, which helps to prevent the brakes from overheating and wearing too rapidly. If additional braking effort is required, do not depress the

brake pedal with one continuous press, but operate it at intervals.



#### **Danger.**

While the vehicle is in motion, never keep the brake pedal continuously depressed, e.g. avoid allowing the brakes to slip as a consequence of you resting your foot on the pedal. This causes the brake system to overheat, increases the braking distance and may result in a complete loss of braking effect.

Ball hitch trailer coupling (fixed) (option)

Ball hitch trailer coupling (fixed) (option)

**i** Note:

Observe the operating instructions issued by the trailer manufacturer.

- ▶ Secure the trailer against rolling away.
- ▶ Reverse the vehicle until the towing ball on the trailer drawbar is positioned precisely above the ball end on the vehicle.
- ▶ Hitch the trailer as described in the operating instructions issued by the trailer manufacturer.

Ball hitch trailer coupling and open-jaw trailer coupling (detachable) (option)

**i** Note:

Observe the operating instructions issued by the trailer manufacturer.

**i** Note:

Observe the operating instructions issued by the trailer coupling manufacturer.

- ▶ Secure the trailer against rolling away.
- ▶ The trailer coupling is fitted to the mounting on the end cross member.
- ▶ To gain access to the mounting, remove the cover from the bumper and stow the cover inside the bus.



M00\_00-0512-71

- ▶ Installation: slide catch (2) backwards and hold in this position. Turn cover (3) through approximately 30° and remove. Fit the trailer coupling in reverse order.

**i** Note:

Removal in reverse order. The trailer coupling must be removed whenever it is not in use.

## Connecting the power supply

### Connecting the power supply



#### Note:

Before connecting the cable, check that the voltage of the consumers on the trailer is the same as the voltage of the consumers on the towing vehicle.

- ▶ To gain access to the trailer socket, remove the cover from the bumper and stow the cover inside the bus.
- ▶ Insert the trailer connector into the socket on the bus.



#### Note:

Route the cable in such a way that it yields to any movement without tension, kinking or friction, including movements associated with cornering.

- ▶ Check that the lights on the trailer are clean and working correctly.

### Trailer coupling maintenance

- ▶ Clean the trailer coupling and lubricate it with multipurpose grease.
- ▶ Check the screws securing the trailer coupling to the end cross member for firm seating. Look for the inspection paint.



#### Danger.

If the threadlocking paint is damaged, the trailer coupling must be checked and resecured by a Service Partner. It is prohibited to use the trailer coupling until then.

### Refuelling (diesel fuel)

The vehicle has a two-tank system fitted to the front of the front axle. The fuel tanks are interconnected through their bases by a fuel line. The bus can be refuelled from either side. If the fuel tanks on your bus are interconnected, it is necessary to remove the fuel cap from each of the fuel tanks.

The addition of flow improvers is not permitted.

Switch off the engine and auxiliary heating before refuelling. Park the bus on a level surface.

Cleanliness is of utmost importance when refuelling. Do not leave cotton rags or cloths in the vicinity of the open filler neck.



#### Caution:

Refuel using only commercially available, sulphur-free diesel fuel complying with European standard EN 590 as revised from 2010 onwards (max. 0.001 % sulphur by weight). Fuels containing more than 0.001 % sulphur by weight or other

types of fuel such as marine diesel fuel, heating oils or fatty acid methyl ester FAME (biodiesel fuel) are not permitted. These types of fuel would cause irreversible damage to the engine and BlueTec®6 exhaust gas aftertreatment system and considerably reduce expected service life.

**Danger.**

Risk of injury and explosion. Fuel is highly flammable. Fire, naked flames and smoking are therefore prohibited when fuel is being handled.

**Danger.**

Before refuelling, switch off the auxiliary heating to prevent fuel vapours from igniting on the auxiliary heating exhaust system.

**Danger.**

Fuel is toxic and harmful to health. For this reason, make sure that the fuel does not come into contact with skin, eyes or clothing, that you do not inhale fuel vapours and that children are kept away from the fuel.

**Danger.**

If you or others have come into contact with fuel: In case of contact with the eyes, rinse them immediately and copiously with clean water and seek medical attention. Clean affected areas of skin immediately with soap and water. Immediately change out of clothing that has come into contact with fuel. If fuel has been swallowed, seek medical attention immediately.

**Environmental protection**

If handled improperly, fuels constitute a hazard to health and the environment. Fuels must not be allowed to enter the sewerage system, surface water, ground-water or soil.

### BlueTec® exhaust gas cleaning system

#### BlueTec® exhaust gas cleaning system

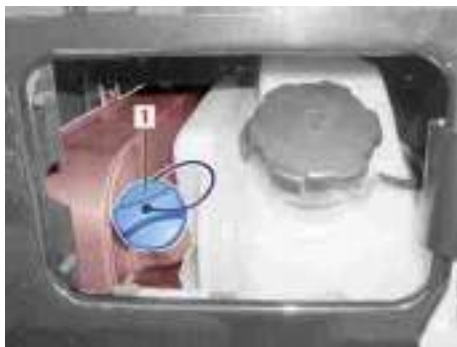

M47\_00-0055-71

The BlueTec® exhaust gas cleaning system essentially comprises a supply tank, a catalytic converter and an AdBlue® metering system. It is monitored and controlled electronically. Pollutants in the exhaust gas are converted into environmentally friendly substances by the addition of AdBlue® and the catalytic converter integrated into the silencer. The illustration above shows filler opening (1) for the AdBlue® supply tank (next to the diesel tank).



#### Note:

AdBlue® is consumed at a rate of approximately 3 % of the rate of diesel fuel consumption. It is recommended that the AdBlue® supply tank also be refilled at every regular refuelling stop.

To function correctly, the BlueTec® exhaust gas cleaning system requires the addition of a reducing agent (AdBlue®). The addition of AdBlue® does not form part of the routine scope of bus maintenance – it is the responsibility of the vehicle operators to ensure that the AdBlue® supply tank is regularly replenished. Filling and operating the bus with AdBlue® is mandatory for compliance with emission regulations and is thus one of the conditions for the road traffic approval of the bus. The road traffic approval of the bus will be invalidated if the bus is operated without AdBlue®. It would then be against the law to operate the bus on public roads. In some countries, operation of the bus without AdBlue® may be considered to be a criminal offence or a violation of administrative

law punishable by fine. Support in the purchase or operation of the bus, i.e. tax relief, road tax, may also be invalidated retrospectively. This may be the case both in the country in which the vehicle is registered and in other countries in which the vehicle is operated.



#### Danger.

It is essential that work relevant to safety or work on safety-related systems be carried out at a qualified specialist workshop.



#### Danger.

Always have maintenance work carried out at a qualified specialist workshop which has the necessary knowledge and tools.

**Note:**

AdBlue® freezes at a temperature of approximately -11 °C. The bus is equipped with an AdBlue® preheating system as standard. Winter operation is therefore guaranteed, even at temperatures of below -11 °C.

**Environmental protection**

AdBlue® is biologically degradable. Unless it is handled properly, however, AdBlue® constitutes an environmental hazard. Do not allow AdBlue® to enter the sewerage system, surface water, groundwater or soil in significant volumes.

**Danger. Risk of poisoning and injury.**

AdBlue® is not classified as a hazardous substance by German regulations governing hazardous substances. Nevertheless, certain points should be observed when handling AdBlue®.

The AdBlue® line system and the system components connected to it are pres-

surised while the engine is warm. There is a risk of scalding from hot AdBlue® spraying out if the line system is suddenly opened. There is also the risk of skin irritation or damage to the eyes if AdBlue® comes into contact with the skin or eyes.

- Wear gloves
- Wear protective clothing
- Wear safety goggles
- Work on the exhaust gas aftertreatment system should not be commenced until approximately 4 minutes have passed as individual lines continue to be flushed even after the engine has been switched off.
- Switch the ignition starter switch to the "OFF" position and remove the key before work is carried out on the SCR system.
- Allow the AdBlue® line system to cool down
- Open line connections and system component covers/caps slowly.
- Capture any AdBlue® that escapes in a suitable container and dispose of it in an environmentally responsible manner.

- Do not pour AdBlue® into drinks containers.
- Wipe up any spilled AdBlue®, especially as there is a risk of slipping.
- AdBlue® collected in this way must not be poured back into the AdBlue® supply tank.
- Rinse affected areas of skin copiously with clean water.
- Quickly change out of clothing that has come into contact with the substance.
- In case of contact with the eyes, rinse them immediately and copiously with clean water and seek medical attention if necessary.
- If AdBlue® enters the mouth or is swallowed, rinse the mouth out with clean water and then drink plenty of water.
- Seek medical attention if symptoms persist.

## AdBlue® service product

### AdBlue® service product

AdBlue® is a non-flammable, colourless, odourless water-soluble liquid.



#### Caution:

Use only AdBlue® complying with DIN 70070/ISO 22241. Special additives are not permitted.



#### Caution:

If, during a top-up, AdBlue® comes into contact with painted or aluminium surfaces, rinse down these surfaces with water immediately.



#### Note:

Avoid inhaling ammonia vapours. Fill the AdBlue® reservoir only in well-ventilated areas.



#### Note:

AdBlue® should not be swallowed or allowed to come into contact with skin, eyes or clothing. Keep AdBlue® out of the reach of children.



#### Note:

If you do come into contact with AdBlue®, observe the following: Wash AdBlue® off skin immediately with soap and water. If AdBlue® gets into the eyes, rinse them immediately and copiously with clean water. Seek medical attention without undue delay. If you have swallowed AdBlue®, immediately rinse your mouth out with water and then drink plenty of water. Seek medical attention without undue delay. Change out of clothing contaminated with AdBlue® immediately.

Properties of AdBlue® at high temperatures



#### Note:

Ammonia vapours may be released as a product of the decomposition of AdBlue® if the content of the AdBlue® tank heats up to over 50 °C for a lengthy period (e.g. as a consequence of direct sunlight).



#### Note:

Ammonia vapours have an acrid odour. For this reason, you should avoid inhaling any ammonia vapours that may escape when you remove the AdBlue® filler cap. Ammonia vapours are an irritant mainly to skin, eyes and mucous membranes.

Properties of AdBlue® at low temperatures



#### Note:

AdBlue® freezes at a temperature of approximately -11 °C. The bus is equipped with an AdBlue® preheating system as standard. Winter operation is therefore guaranteed, even at temperatures of below -11 °C.



## AdBlue® additives

**Caution:**

Do not add any additives to AdBlue®. Do not dilute AdBlue® with tap water. Doing so could destroy the exhaust gas cleaning system. Damage to the exhaust gas cleaning system caused by additives/tap water will invalidate the warranty.

## Storage

**Caution:**

For the storage of AdBlue®, use only containers made from polypropylene, polyethylene or high-alloy CrNi steels or Mo-CrNi steels complying with DIN EN10088-1/2/3. Containers made of aluminium, copper, cupriferous alloys and non-alloyed or galvanised steels are not suitable for the storage of AdBlue®. If stored in such containers, AdBlue® could dissolve out constituents of these metals and destroy the exhaust gas cleaning system. The vehicle warranty will be invalidated if damage to the exhaust gas cleaning system is found to have been caused

by constituents dissolved out of non-approved storage containers.

## Disposal of AdBlue®

**Note:**

Observe country-specific legislation and requirements governing the disposal of AdBlue®.

## AdBlue® purity

**Note:**

It is prohibited to return to the tank any AdBlue® that has been pumped out, e.g. during a repair, because the purity of the liquid would no longer be guaranteed.

## Filling with AdBlue®

**Note:**

An accidental filling of the AdBlue® supply tank with diesel fuel and vice versa is prevented by various technical precautionary measures.

**Note:**

It is recommended that the AdBlue® supply tank also be refilled at every regular refuelling stop.

**Caution:**

Use only AdBlue® complying with DIN 70 070/ISO 22241. Special additives are not permitted.

## Filling with AdBlue®



### Caution:

If, during a top-up, AdBlue® comes into contact with painted or aluminium surfaces, rinse down these surfaces with water immediately.



### Note:

AdBlue® freezes at a temperature of approximately -11 °C. The bus is equipped with an AdBlue® preheating system as standard. Winter operation is thus ensured, even at temperatures below -11 °C.



M47.00-0143-71

- ▶ Read AdBlue® fill level (5).
- ▶ If the fill level in the AdBlue® supply tank falls to approximately 10 %, a yellow alert (1) appears on the display screen. The yellow alert displays the icon and the message “AdBlue® Reserve”. The driver can acknowledge yellow alert (1) at any time using the OK button on the steering wheel. AdBlue® indicator (6) turns yellow and remains lit to remind the driver that an AdBlue® top-up is due. Yellow warning lamp (4) does not go out until the vehicle has been refilled with AdBlue®.

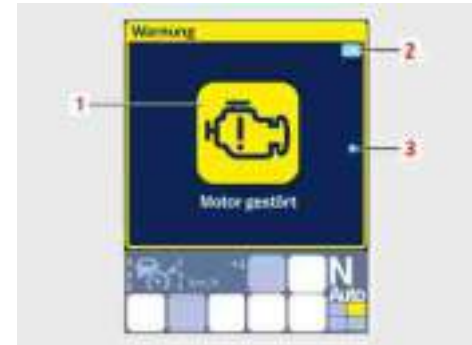

M47.00-0144-71

- ▶ If the AdBlue® supply tank runs empty, this yellow alert (1) appears on the display screen first. The yellow alert displays the icon and the message “Motor gestört” (Engine malfunction). In this event, it is necessary to top up the AdBlue® level immediately.



### Note:

The driver must have actively acknowledged the “AdBlue® Reserve” yellow alert at some time previously.



M47.00-0145-71

If the AdBlue® supply tank remains unreplenished, an engine power reduction is initiated and this yellow alert (1) appears. Yellow alert (1) displays an icon and the message “Motorleistung reduziert” (Engine power reduced). The driver can acknowledge the yellow alert at any time

using OK button (2) on the steering wheel.



M47.00-0142-71

- Add AdBlue® to the supply tank.



### Note:

The AdBlue® supply tank is located directly next to the diesel tank on the right-hand side to the front of the front axle.



### Note:

An accidental filling of the AdBlue® supply tank with diesel fuel and vice versa is prevented by various technical precautionary measures.

## Diesel particulate filter

### Diesel particulate filter

Under normal circumstances, automatic regeneration of the diesel particulate filter is sufficient to avoid heavy soot loading of the filter. However, if the bus is predominantly driven short distances or with the engine under low load, it might not be possible for automatic regeneration to finish successfully.

A yellow "particle filter" indicator lamp  in the instrument cluster will then warn that the diesel particulate filter is nearing a high load state and indicate that action may need to be taken.

The on-board computer gives prompt warnings of emission-relevant malfunctions or user errors and displays their respective priority by means of a grey, yellow or red event window along with the associated plain text message.

If these event windows and their instructions are disregarded, there is a risk of engine power output being reduced and a need to exchange the diesel particulate filter prematurely.



#### Note:

As long as no flashing yellow or constant red malfunction alert appears, it can also be sufficient to alter the load profile (e.g. take the bus for a drive on the motorway) in order to ensure that automatic regeneration of the diesel particulate filter finishes successfully.



#### Note:

In the event of a malfunction in the BlueTec® exhaust gas aftertreatment system, have the system checked and repaired at a qualified specialist workshop.



#### Danger.

Exhaust fumes are produced during the manual regeneration process (parked regeneration). If you were to inhale these exhaust fumes, you could suffer harmful effects such as poisoning. For this reason, the bus should always be parked outdoors. If, however, the bus is parked in an enclosed room, adequate ventilation must be ensured.



#### Danger.

Very hot exhaust fumes are expelled from the exhaust tail pipe during the manual regeneration process (parked regeneration). Keep well clear of the exhaust tail pipe. Otherwise, you could be burned by the fumes. The use of an extraction system should be avoided because this will generally not have been designed to withstand the exhaust temperature levels that arise.

**Danger.**

Make sure that no highly flammable materials, e.g. dry grass or fuels, come into contact with the exhaust system during the manual regeneration process (parked regeneration). Do not leave the bus parked up at a filling station, on dry grass or on harvested crop fields. The hot exhaust system could otherwise cause the highly flammable material to ignite and set the bus on fire.

**Danger.**

The exhaust tail pipe has been designed in such a way that the exhaust gas temperature falls relatively quickly with increasing distance. For this reason, no other exhaust tail pipe may be fitted.

If the diesel particulate filter load state becomes critical, a yellow indicator lamp lights up in the instrument cluster. The on-board computer displays a yellow event window prompting you to start manual regeneration (parked regeneration). The manual regeneration process

lasts approximately 30 to no more than 60 minutes.

**Note:**

The time needed for manual regeneration is dependent on the temperature of the exhaust system.

**Note:**

If the yellow event window and its message are disregarded, there is a risk of engine power output being reduced and a need to exchange the diesel particulate filter prematurely.

**Danger.**

Exposure to diesel soot and soot particles through contact or inhalation is harmful to health and can lead to death. If you need to exchange a diesel particulate filter yourself due to technical problems, be sure to observe the information and instructions in the workshop information and all applicable occupational safety and accident-prevention regulations. Wear

gloves and a dust mask. Seal and pack a particle-laden diesel particulate filter in the original packaging immediately after removal. A particle-laden diesel particulate filter must be labelled and must not under any circumstances be left uncovered indoors.

▷ For instructions on how to initiate diesel particulate filter regeneration manually (parked regeneration), refer to the “Starting regeneration of the diesel particulate filter manually” section.

## Diesel particulate filter regeneration

### Diesel particulate filter regeneration

#### Functions:

- Automatic regeneration of the diesel particulate filter
- Inhibiting automatic regeneration of the diesel particulate filter
- Catalytic converter protection function

### Automatic regeneration of the diesel particulate filter

Whenever the green “Particulate filter” indicator lamp  in the instrument cluster lights up, this means that the diesel particulate filter is undergoing automatic regeneration.



#### Note:

Automatic regeneration does not start unless all necessary operating conditions have been fulfilled, e.g. engine oil or exhaust gas temperatures sufficiently high and engine running.



#### Note:

If regeneration is in progress and one of the operating conditions is subsequently no longer fulfilled, the green indicator lamp  goes out prematurely and regeneration is aborted.



#### Note:

It restarts automatically when all necessary operating conditions are fulfilled again. For this reason, avoid interrupting a journey while the green “Particulate filter” indicator lamp  is lit.



#### Note:

If the elevated exhaust gas temperatures associated with regeneration may present a danger, e.g. where the heat produced may jeopardise safety, it is possible to inhibit the automatic regeneration process.

### Inhibiting automatic regeneration of the diesel particulate filter



M54.00-2038-71

If the elevated exhaust gas temperatures associated with regeneration may present a danger, e.g. where the heat produced may jeopardise safety, it is possible to inhibit the regeneration process. Neither automatic nor manual regeneration can then be initiated and regeneration is stopped if it is already in progress.

Press the lower section of pushbutton (1).

Diesel particulate filter regeneration



**Note:**

The LED in the “Inhibit regeneration” pushbutton comes on and no regeneration can be started.



**Caution:**

Leave the regeneration inhibitor activated only for as long as the danger exists. Whenever you activate the regeneration inhibitor, regeneration will continue to be inhibited even after the next engine start.



**Note:**

There would otherwise be a risk of rapid loading of the diesel particulate filter. In this event, the on-board computer reminds you with a grey “Regeneration inhibited” event window that the regeneration inhibitor is still active.



M54.00-2233-71

To deactivate, press the lower section of inhibit pushbutton (1) again.



**Note:**

The LED in the pushbutton goes out.

**Catalytic converter protection function**

In very rare cases (e.g. frequent low load operation with relatively low exhaust temperatures), unburnt fuel could collect in the exhaust system. The exhaust system could suffer damage as a result.

To prevent this, the engine speed is automatically increased for approximately 20 to 30 minutes by the exhaust gas aftertreatment control module under specific circumstances. This raises the exhaust temperature and burns off the fuel.



**Note:**

This function can only be started with the vehicle parked (parking brake engaged) and the engine idling.



**Note:**

A corresponding message appears on the display screen to indicate that the catalytic converter protection function is active.



**Note:**

It is possible to interrupt this function by switching off the engine, engaging a gear or releasing the parking brake.

### Starting regeneration of the diesel particulate filter manually (parked regeneration)

#### Starting regeneration of the diesel particulate filter manually (parked regeneration)

- ▶ Pull over safely with regard for other traffic and leave the engine running. Be sure to park well clear of other vehicles, objects and all flammable materials.



#### Danger.

Very hot exhaust fumes are expelled from the exhaust tail pipe during the manual regeneration process (parked regeneration). Keep well clear of the exhaust tail pipe. Otherwise, you could be burned by the fumes.



#### Caution:

Only carry out manual regeneration outdoors or in well-ventilated rooms. The use of an extraction system should be avoided because this will generally not have been designed to withstand the exhaust temperature levels that arise.



#### Caution:

Make sure that no highly flammable materials, e.g. dry grass or fuels, come into contact with the exhaust system during the manual regeneration process (parked regeneration). Do not leave the bus parked up at a filling station, on dry grass or on harvested crop fields. The hot exhaust system could otherwise cause the highly flammable material to ignite and set the bus on fire.



#### Note:

Under normal circumstances, automatic regeneration of the diesel particulate filter is sufficient to avoid heavy soot loading of the filter. However, if the bus is predominantly driven short distances or with the engine under low load, it might not be possible for automatic regeneration to finish successfully.



#### Note:

If the diesel particulate filter load state becomes critical, a yellow "particle filter" indicator lamp lights up in the instrument cluster. The on-board computer then displays a yellow event window prompting you to start manual regeneration. The manual regeneration process lasts approximately 30 to no more than 60 minutes.

- ▶ Apply the parking brake.
- ▶ Shift the transmission to neutral N.
- ▶ Take your foot off the accelerator pedal.
- ▶ If active, deactivate the regeneration inhibitor.



#### Note:

refer to "Inhibiting automatic regeneration of the diesel particulate filter".



## Starting regeneration of the diesel particulate filter manually (parked regeneration)



M54.00-2232-71

- ▶ Press and hold the upper section of “Manual regeneration” pushbutton (1) for approximately 3 seconds.

**i** **Note:**

Manual regeneration cannot be started unless the engine oil and exhaust gas temperatures are sufficiently high, the AdBlue® is not frozen and the system is functioning normally.

The green “Particulate filter” indicator lamp  in the instrument cluster comes on and engine speed is increased.

When regeneration has been finished, the green indicator lamp in the instrument cluster goes out and engine speed drops to idling speed.

**i** **Note:**

Regeneration will be aborted automatically if you deselect transmission neutral position, release the parking brake or activate the regeneration blocking function by pressing the lower section of the “Regeneration blocking” pushbutton.

**i** **Note:**

Engine speed drops to idling speed if the process is aborted.

**i** **Note:**

Regeneration cannot be started unless all necessary operating conditions have been fulfilled, e.g. engine oil or exhaust gas temperatures sufficiently high. If the on-board computer prompts manual regeneration at low outside temperatures, start the regeneration process before the

vehicle is parked. If you were to park the vehicle without initiating regeneration, you would not be able to start the regeneration process manually until after a subsequent engine warm-up phase. If you were to park the vehicle without initiating regeneration and the AdBlue® were frozen, you would not be able to start the regeneration process manually until after a thawing period of up to 60 minutes.

### Function description: accident data recorder (ADR) (option)

#### Function description: accident data recorder (ADR) (option)

- ▶ The accident data recorder (ADR) is a system for detecting and recording accidents and driving events, e.g. pulling away against a kerb or sudden braking.
- ▶ The ADR is activated automatically when the ignition is switched on.



#### Note:

The ADR remains active for 3 days after the ignition has been switched off and continues to register all vehicle movements (e.g. parking collisions).



M54\_00-1502-71

- ▶ As soon as the ignition is switched on, the ADR carries out a self-test and provides audible notification of the current operating status or the presence of a hardware fault.



#### Note:

A brief, one-off audible signal (buzzer in the control panel) (4) indicates that the ADR is ready for operation.



#### Note:

Indicator lamp (2) lighting up and a brief, one-off buzzing sound means that at least one event is stored.



#### Note:

A sequence of four long buzzes indicates that the ADR has detected a parking collision. Check your vehicle for damage.



#### Note:

Eight short buzzes mean that the memory of the ADR is almost full to capacity. Export the events and have the memory cleared.



#### Note:

Ten short buzzes mean that the ADR has malfunctioned. Similarly, a malfunction is present if no signal sounds.

## Brake system safety precautions

- ▶ Following any critical traffic or accident situation, it is possible to record an entry manually.

**Note:**

When pushbutton (1) is pressed following an accident, the event (approximately 43 seconds before, during and after the accident) is stored and remains write-protected for an extended period.

## Brake system safety precautions

**Caution:**

The braking characteristics of the bus may change if a yellow warning level malfunction in the brake system appears on the instrument cluster display screen. Adopt a particularly cautious driving style. Have the malfunction rectified as soon as possible by an OMNIplus Service Partner.

**Danger.**

The braking characteristics of the bus have changed if a red warning level malfunction in the brake system is displayed. Pedal travel may increase under braking. ABS has been disabled. Stop the bus immediately and disable it (traffic conditions permitting). Have the malfunction rectified by an OMNIplus Service Partner immediately.

## Emergency braking

- ▶ In the event of danger, depress the brake pedal fully.

**Note:**

If you brake heavily at a speed of over 30 mph (50 km/h) and Brake Assist is active, the brake lamps will flash rapidly. This provides a warning to road users behind the vehicle.

## Braking and stopping

### Braking and stopping

- ▶ When the bus is driven over long downhill stretches, you should make use of the braking effect of the engine by shifting into a lower gear. Use the continuous brakes (retarder, engine brake) to relieve the load on the service brake.



#### Note:

Except for emergencies, the service brake does not usually need to be applied sharply.



#### Note:

Always apply the parking brake before you disembark. On uphill and downhill gradients, you must also chock the wheels and turn the steering towards the kerb.

### Brakes with anti-locking protection

- ▶ In a hazardous situation, the brake pedal should be depressed fully. This ensures that all wheels are braked with ABS assistance and optimum deceleration is achieved.



#### Note:

The retarder is deactivated automatically for the duration of an ABS control intervention.



#### Danger.

The anti-locking protection of ABS does not relieve the driver of the responsibility for adopting a driving style which takes traffic and road conditions into account. While the directional stability and steerability of the bus are improved under braking, ABS is not able to avert the consequences of driving at an unsafe distance from the vehicle in front or driving too fast through corners.



#### Danger.

If the bus is towing a trailer that does not have ABS, this trailer could be overbraked if the brakes were applied with maximum force. In this case, the driver must keep an eye on the trailer in the rear-view mirror. The bus equipped with ABS remains steerable, thereby enabling the driver to keep the entire vehicle combination stable.

### Applying the parking brake



M42\_00-0445-01

- Pull hand lever (1) out of released position (a) and into engagement in applied position (b).



**Danger.**

Do not apply the parking brake unless the bus is stationary. Always apply the parking brake before you leave the driver's area. On steep uphill and downhill gradients, you should also chock the wheels and turn the steering towards the kerb.



**Danger.**

With the parking brake applied, ABS can no longer perform its intended function - risk of skidding.



**Note:**

If the ignition is switched off without the parking brake engaged, a warning tone will sound and a red alert will be displayed with the message: "Feststellbremse einlegen" (Apply parking brake).



**Danger.**

Check the hand lever for full engagement. To do so, attempt to press the hand lever in the "release" direction (a) without pulling release ring (1.1) out of the detent position. The lever must not move.



The parking brake indicator lamp lights up on the instrument panel and this operating symbol appears on the screen at the same time.

## Releasing the parking brake



M54.00-2121-71



### Note:

If the ignition is switched off without the parking brake engaged, a warning tone will sound and a red alert (1) will be displayed with the message: "Feststellbremse einlegen" (Apply parking brake).

## Releasing the parking brake



M42\_00-0446-01

- ▶ Pull release ring (1.1) out of the de-entenged position (b) and move hand lever (1) as far as the stop towards the released position (a).



M42.00-0839-71

- ▶ Indicator lamp (1) must go out.



### Note:

To guarantee a faultless release of the parking brake, there must be sufficient supply pressure available. If parking brake indicator lamp (1) does not go out even if there is sufficient supply pressure available, there is a defect in the brake spring cylinder circuit or the emergency release circuit. Have the brake system checked by an OMNIplus Service Partner immediately.

## Emergency braking in the event of failure of both brake circuits

### Emergency braking in the event of failure of both brake circuits



**Danger.**

A failure in brake circuits 1 and 2 will jeopardise the operating safety and road-worthiness of the bus. Stop the vehicle immediately (traffic conditions permitting). Have the brake system checked by an OMNIplus Service Partner immediately.



**Note:**

In the event of a failure in brake circuits 1 and 2, it is possible to initiate emergency braking using the parking brake lever.

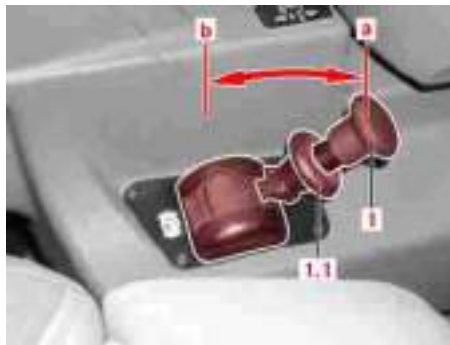

M42\_00-0446-01

- ▶ Pull release ring (1.1). Pull lever (1) slowly towards applied position (b) and hold it in the desired position to prevent it from automatically returning to released position (a).



**Danger.**

If it is necessary to perform emergency braking using the parking brake, do not allow the parking brake lever to engage in the parking position. Keep release ring (1.1) in the applied position.

The bus is braked at the rear wheels only.



**Note:**

Parking brake lever (1) can be moved rearwards to any position to enable the driver to prevent the rear wheels from locking and to moderate the braking effect.



**Danger.**

Risk of accident. Applying the parking brake deactivates the anti-lock braking system (ABS). You should exercise even more caution when driving on slippery roads because there would be a risk of rear wheels locking.

## EBS brake system

### EBS brake system

The electronic brake system (EBS) controls the vehicle's braking behaviour. The anti-lock braking system (ABS) and acceleration skid control (ASR) functions are part of the electronic brake system (EBS).

EBS helps to achieve a more rapid braking effect at the wheels. ABS prevents the wheels from locking above a speed equivalent to walking pace, regardless of the road conditions.

EBS comprises two circuits: a purely pneumatic brake circuit and a superimposed electropneumatic brake circuit. Each wheel is equipped with sensors that continuously record the rate of brake pad wear. An overly worn brake pad is indicated by a yellow alert and the "Brake pads" symbol on the display screen.

Under partial braking, the braking pressures are adapted between the front axle and rear axle as a function of the brake pad thickness to ensure even wear of the brake pads.

### Acceleration skid control (ASR)



M54.00-2005-71

Acceleration skid control prevents the drive wheels from spinning when pulling away or accelerating, regardless of road surface conditions.



Acceleration skid control does not relieve the driver of the responsibility for adopting a driving style which takes traffic and road conditions into account. The bus may skid out of control if ASR has been switched off and the drive wheels start to spin.



### Note:

Indicator lamp (1) flashes while acceleration skid control (ASR) is intervening.



M54.00-1945-71



**Note:**

It is recommended that acceleration skid control (ASR) be deactivated using “ASR/ESP OFF” pushbutton (1) if traction problems are experienced when driving with snow chains fitted or over loose surfaces (e.g. sand or gravel) (refer to “Deactivating acceleration skid control (ASR)/Electronic Stability Program (ESP)” in this section).

**Brake Assist**

Brake Assist interprets a dangerous situation from the speed with which the brake pedal is depressed and immediately generates maximum braking force. Brake Assist acts to minimise braking distances.

**Adaptive brake lamps**

If you brake heavily at a speed of over 50 km/h and Brake Assist is active, the brake lamps will flash rapidly. This provides a warning to road users behind the vehicle.

### Electronic Stability Program (ESP) (system description)

#### Electronic Stability Program (ESP) (system description)

Dynamic handling control (FDR) acts to prevent the bus from skidding or tilting (subject to the laws of physics), regardless of vehicle load and road surface conditions, and particularly in critical driving situations (e.g. sudden evasive manoeuvre or high cornering speed). This is achieved by selective braking of individual wheels or, where necessary, all wheels. Combined with acceleration skid control (ASR), this system is called the Electronic Stability Program (ESP). ESP remains operational even when the service brake is applied or a continuous brake is active.



#### **Danger.**

**RISK OF ACCIDENT.** The Electronic Stability Program (ESP) does not relieve the driver of the responsibility for adopting a driving style which takes traffic and road conditions into account. The ability of ESP to restabilise the bus is subject to the laws of physics. The bus may skid

out of control if the Electronic Stability Program (ESP) has been deactivated and the drive wheels start to spin.



#### **Note:**

In wintry conditions, optimum performance of the Electronic Stability Program (ESP) cannot be achieved unless winter tyres (M+S) are fitted.



#### **Note:**

It is recommended that the Electronic Stability Program (ESP) be deactivated using “ASR/ESP OFF” pushbutton (1) if traction problems are experienced when driving with snow chains fitted or over loose surfaces (e.g. sand or gravel).



M54.00-1945-71

## Electronic Stability Program (ESP) (function description)

Electronic Stability Program (ESP)  
(function description)

## Functions:

- Electronic Stability Program (ESP) function description
- Handling in the event of understeering
- Handling in the event of oversteering

Electronic Stability Program (ESP)  
function description

M42.00-0840-71

The Electronic Stability Program (ESP) is an extension of the Electronic Brake System (EBS), which already features

the anti-lock braking system (ABS) and acceleration skid control (ASR). If ESP detects a critical driving situation, automatic control interventions stabilise the bus by:

- reducing engine power output
- selectively braking individual wheels
- applying the brakes at all wheels

**i** Note:

Indicator lamp (1) flashes while the Electronic Stability Program (ESP) is intervening.

**i** Note:

Dynamic handling control (FDR) is active only at speeds of over 10 km/h. Dynamic handling control (FDR) is deactivated whenever reverse gear is selected.

**i** Note:

The Electronic Stability Program (ESP) is deactivated automatically in the event of an ESP malfunction or a technically related malfunction in the Electronic Brake System. In this case, indicator lamp (1) lights up permanently.

**i** Note:

Indicator lamp (2) lights up permanently if the ESP function has been deactivated by means of the “ESP OFF” pushbutton on the instrument panel (refer to “Deactivating acceleration skid control (ASR)/ Electronic Stability Program (ESP)” in this section).

## Electronic Stability Program (ESP) (function description)

### Handling in the event of understeering

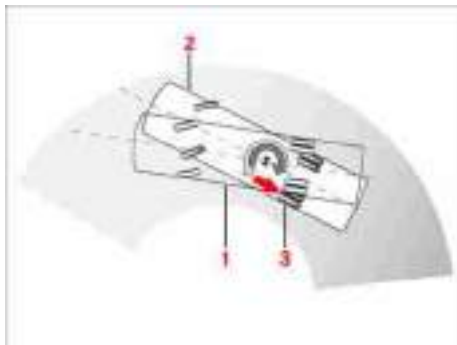

M42\_25\_0003\_01

The front axle of the bus deviates from steered course (1) towards the offside of the road (2). Selective braking of the rear wheel on the nearside (3) restabilises the bus.



#### Note:

The illustration shows a 2-axle bus as an example. In the case of 3-axle buses equipped with RAS, the 3rd axle is regulated separately as necessary.

### Handling in the event of oversteering

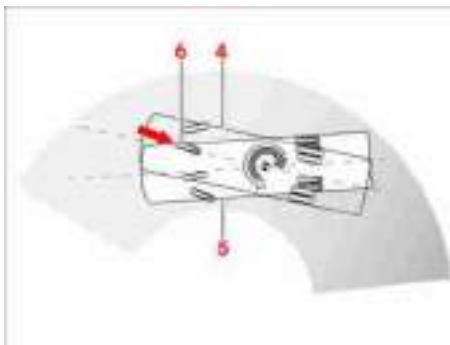

M42\_25\_0002\_01

The bus breaks out at the rear axle. The bus deviates from steered course (4) and turns towards the near side of the road (5). Selective braking of the front wheel on the offside (6) restabilises the bus.



#### Note:

The illustration shows a 2-axle bus as an example. In the case of 3-axle buses equipped with RAS, the 3rd axle is regulated separately as necessary.

## Deactivating acceleration skid control (ASR)/Electronic Stability Program (ESP)

### Deactivating acceleration skid control (ASR)/Electronic Stability Program (ESP)



M54.00-1945-71

- ▶ Press "ASR/ESP OFF" pushbutton (1).

**i** **Note:**

Pressing "ASR/ESP OFF" pushbutton (1) again or switching the ignition starter switch to OFF and back to ON reactivates acceleration skid control (ASR) and the Electronic Stability Program (ESP).

**!** **Danger.**

RISK OF ACCIDENT. The bus may skid out of control if acceleration skid control (ASR) has been switched off and the drive wheels start to spin.

**i** **Note:**

It is recommended that acceleration skid control (ASR) be deactivated using "ASR/ESP OFF" pushbutton (1) if traction problems are experienced when driving with snow chains fitted or over loose surfaces (e.g. sand or gravel).



M54.00-2005-71

"ASR OFF" indicator lamp (1) lights up permanently.

**i** **Note:**

The control functions of acceleration skid control (ASR) are deactivated.

## Operating 230/400 V systems (option)



M42.00-0840-71

- ▶ “ESP OFF” indicator lamp (2) also lights up.

### Operating 230/400 V systems (option)

Special safety precautions must be taken when operating 230/400 V systems; these will be described below:



**Danger.**

Maintenance and repair work may only be carried out by personnel who have undergone the appropriate special training.

- ▶ The system manufacturer's safety and operating information must be observed without fail.



**Danger.**

Residual current devices fitted in the bus must be function-tested at regular intervals.

The following safety precautions are an absolute requirement if the 230/400 V system is to be supplied by an outside feed:



**Note:**

Check any extension lead used for damage before plugging it in.



**Note:**

The networks to which the 230/400 V system is connected must have protection in the form of a residual current device. Otherwise, plug in an external RCD as an adapter.



**Note:**

Check the correct operation of this RCD by pressing the test button. Only then should you connect the 230/400 V system of the bus to the mains supply.

### Fitting the skibox (option)



**Danger.**

The skibox may only be transported, stored and assembled by using the sub-assemblies and fastening elements that are designed for that purpose.



**Danger.**

The installation of a skibox changes the bus length and any installed reversing monitor (park pilot) no longer functions.

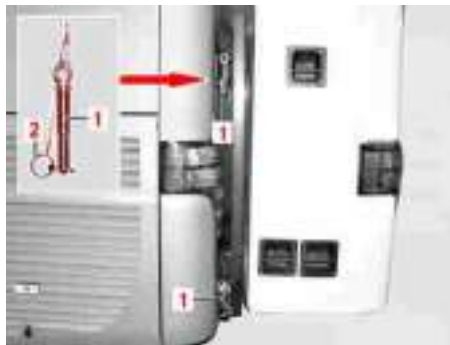

M88\_00-0019-01

- ▶ The skibox is fitted to the bus by pinning the four swivel bearings on the left and right-hand side of the outer frame to the bearing pedestals on the bus using pins secured with split pins (1).



**Note:**

A fork lift truck should be used to raise the box to the correct height to ease assembly onto the bus.

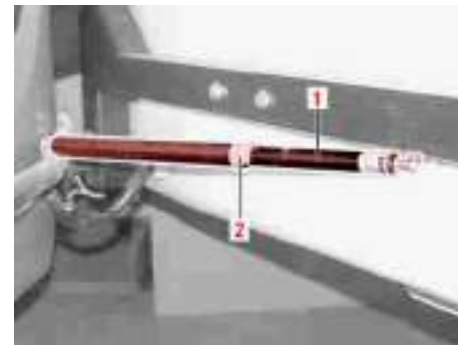

M88\_00-0021-01

- ▶ Only ever stake the lower locating eyes with one pin at a time - never two at once.



**Danger.**

Risk of injury. Make sure that the rear gas strut (1) prestresses the bar.

### Swivelling the skibox (option)



M88\_00-0019-01

- The skibox can only be fitted to buses upon which the correct brackets are installed.



#### Note:

The electrical connection must be established between the bus and skibox once the skibox has been mounted.



#### Danger.

Before the bus is driven, it is necessary to check that all pins (1) are firmly seated and correctly secured by split pin (2).



#### Danger.

All lighting equipment must be checked for correct operation before the bus is driven. In addition, it is necessary to check that the rear foglamp only works on the skibox and no longer on the bus.



#### Danger.

The skibox cover must be closed and locked when the bus is being driven.

### Swivelling the skibox (option)



#### Caution:

Before the box is swivelled it must firstly be unloaded (follow instructions on the sticker on the skibox frame).



## Additional operating instructions for the skibox (option)



M88\_00-0019-01

- ▶ Pull both locating pins (1) on the left-hand side when viewed in the direction of travel (after removing securing split pin (2)) and swivel the box to the right side until the gas strut has reached its end position and the catch for preventing the box from swivelling back unintentionally has snapped in place.

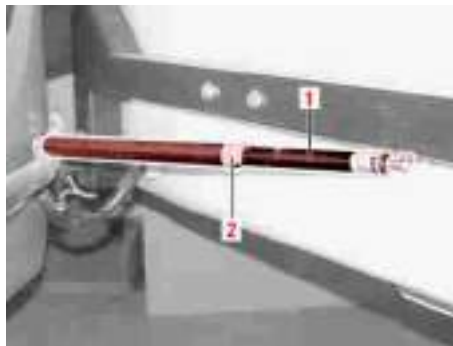

M88\_00-0021-01

- ▶ This catch (2) (orange-yellow push handle on the gas strut (1)) must firstly be raised to allow the box to swivel back.
- ▶ Reinsert the locating pins and secure with securing split pins.

### Additional operating instructions for the skibox (option)

 **Danger.**

The permissible gross vehicle weight must not be exceeded. (Observe the instructions on the sticker inside the skibox.)

 **Danger.**

After the skibox has been loaded, the belts over the support arms must be lashed firmly over the retaining frames in order to secure the load.

 **Caution:**

The use of corrosive soaps for skibox cleaning and care is not permitted (observe the manufacturer's instructions). If an unacceptable amount of dirt has accumulated on the skibox, you should clean it using water and a car shampoo. The use of a high-pressure cleaner is permitted provided you operate it and treat the skibox with care.

### Note on maintenance work

- ▶ To adjust the height of the support arms, remove the fasteners first.



#### **Danger.**

Whenever the height has been adjusted, the respective fastener must be refitted to the support arm and clipped into the wall rail.

- ▶ Pull the folding step for loading and unloading out of the retaining tubes, hook it in using the hooks and fold it out.
- ▶ If there are defective bulbs in the lamp holders, they must be replaced by pulling out the connector sockets and unscrewing the bayonet fitting.

### Note on maintenance work



#### **Note:**

All maintenance work is described in a separate manual. For further information, please consult your EvoBus Service Partner.

### Care and cleaning



#### **Note:**

Observe the laws and regulations in all countries concerned.



#### **Danger.**

Risk of injury. Whenever work is carried out on the bus, all applicable safety regulations must be observed (e.g. operating instructions, environmental laws and regulations, occupational safety and accident prevention regulations, etc.).



#### **Danger.**

Risk of poisoning. Observe the instructions for use of the care and cleaning products.

**Danger.**

Risk of poisoning. Always keep care and cleaning products sealed and out of the reach of children.

**Danger.**

Risk of poisoning. Diesel, regular and premium-grade fuels are harmful to health. They should not be used as a cleaning product.

**Danger.**

Risk of fire. Diesel, regular and premium-grade fuels are highly flammable. They should not be used as a cleaning product.

**Danger.**

Do not use round-spray jets to clean tyres or suspension air bags. The pulsating jet of water could cause concealed damage to the tyre substructure or suspension air bags. This damage would not become

apparent until much later and could cause the tyre or suspension air bag to burst. You could then lose control of your bus and cause an accident, which could result in injury to yourself and others.

**Caution:**

Do not work with high-pressure cleaners or steam cleaners in the region of axle seals (e.g. hubs, drive flange) and axle breathers. In automatic vehicle washes, make sure that these areas will not be severely subjected to jets of water.

**Caution:**

We recommend that only tested and approved care products should be used. Information about acceptable care products can be obtained from your OMNIplus Service Partner.

**Caution:**

For cleaning work in the engine compartment, the use of cleaning agents containing acetone or chloroethylene is prohibited.

**Caution:**

If you are using a steam cleaner to perform cleaning work in the engine compartment, do not aim the jet directly at belt tensioners or idler pulleys.

**Caution:**

Stone chips and impurities, especially insect remains, bird droppings, tree resins, oils and greases, fuels and tar stains, should be remedied immediately with the use of approved care products.

### Cleaning the headlamp plastic cover lenses



#### Caution:

The bus must be cleaned more frequently in winter to remove salt residues from road gritting.



#### Environmental protection

Dispose of empty containers, cleaning cloths and polishing wads in an environmentally responsible manner.

### Cleaning the headlamp plastic cover lenses



#### Note:

The headlamp cover lenses are made from a plastic material (polycarbonate) and painted with a clear coat.



#### Caution:

Wipe with a damp sponge to clean the plastic cover. Do not use an abrasive product or a dry cloth, as this would scratch the surface.



#### Caution:

Do not apply solvents or cleaning agents containing solvents, as the finish is not completely resistant to solvents.



#### Caution:

Failure to observe these measures can lead to damage to the headlamp surface such as a milky coating, matt areas and stress cracking.



## Care/cleaning of light-alloy wheels

## Care/cleaning of light-alloy wheels

**Danger.**

Observe the general information/safety precautions in this section.

**Caution:**

Clean light-alloy wheels regularly.

- ▶ Clean the light-alloy wheels regularly with warm water (preferably with a high-pressure cleaner) and a soft sponge.

**Danger.**

Do not use round-spray jets for cleaning tyres. The pulsating jet of water could cause concealed damage to the tyre substructure. Damage to the tyre substructure would not become apparent until much later and could cause the tyre to burst. You could then lose control of your bus and cause an accident, which could result in injury to yourself and others.

- ▶ For heavy soiling, use a cleaner for light-alloy wheels.

**Note:**

Alcoa Dura-Bright® wheels need only soap and water to retain their sheen. These wheels should not be polished using a standard polish such as ALpolish.

**Note:**

Further information: Alcoa Wheel Products Europe, [www.alcoawheels.com](http://www.alcoawheels.com).

**Caution:**

We recommend that only tested and approved care products should be used. Information about acceptable care products can be obtained from your OMNIplus Service Partner.

**Caution:**

Do not use acidic or alkaline cleaners. They can cause corrosion to the wheel bolts (wheel nuts) or the retaining springs of the balance weights.

## Care and cleaning of covers, upholstery and ceiling

### Care and cleaning of covers, upholstery and ceiling

#### Special notes on care and cleaning of covers and upholstery



#### Note:

Observe the information about your upholstered furnishings and covers contained in the detailed description of the bus.



#### Caution:

Do not use cleaning products containing solvents (e.g. petroleum ether, acetone, alcohol, etc.). This would damage covers and equipment parts made of plastic or foam beyond repair.



#### Caution:

To avoid a bleaching out of colours, use only pH-neutral care and cleaning agents.



#### Note:

These notes on care also apply to cleaning of the ceiling.



### Care/cleaning of fabric covers



#### Danger.

Observe the general information/safety precautions in this section.



#### Note:

Regular care and basic cleaning help to maintain the value and high-quality appearance of fabric covers. For this reason, carry out basic cleaning regularly. Carry out basic cleaning more regularly if necessary, depending on use and the level of dirt.

#### Basic cleaning - weekly

- ▶ Vacuum the covers thoroughly along the nap of the fabric.

**Caution:**

Do not use rubber vacuum nozzles or rubber attachments. These could pull threads out of the upholstered covers.

- ▶ Using a soft brush, brush the fabric along the nap.

**Basic cleaning - every six months**

- ▶ First carry out the weekly basic cleaning.
- ▶ Work up a foam from a mild, lukewarm soap solution (e.g. from a mild-action detergent).
- ▶ Apply the foam evenly over all the covers using a soft, slightly damp sponge.
- ▶ Wait until the freshly cleaned covers are completely dry.

**Caution:**

The covers must be completely dry before they are sat on again. Permanent pressure marks could otherwise form.

- ▶ Brush along the nap of the fabric using a soft brush, without applying pressure.

**Removing stains****Caution:**

Remove dirt as soon as possible to prevent permanent stains or damage to the covers.

- ▶ Remove as much dirt as possible using a lint-free cloth.
- ▶ Using a soft sponge, work a mild, lukewarm soap solution into the dirt in circular movements from the outside in. Apply light pressure when doing this.

**Note:**

Always clean up the dirt from the outside in to prevent it from being dispersed in the fabric.

- ▶ Mop up the soap solution using a clean, soft sponge.
- ▶ Wait until the freshly cleaned areas are completely dry.

**Caution:**

The covers must be completely dry before they are sat on again. Permanent pressure marks could otherwise form.

- ▶ Finally, brush the cover and the cleaned areas using a soft brush along the nap of the fabric.

## Care/cleaning of micro-fibre covers



### Caution:

If in any doubt, use a professional textile cleaning company.

## Care/cleaning of micro-fibre covers



### Danger.

Observe the general information/safety precautions in this section.



### Note:

Regular care and basic cleaning help to maintain the value and high-quality appearance of micro-fibre and wool covers. For this reason, carry out basic cleaning regularly. Carry out basic cleaning more regularly if necessary, depending on use and the level of dirt.

### Basic cleaning - weekly

- ▶ Vacuum the covers along the nap of the fabric, without applying pressure.



### Caution:

Do not use rubber vacuum nozzles or rubber attachments. These could pull threads out of the upholstered covers.

- ▶ Using a soft brush, gently brush the upholstery down along the nap of the fabric.

### Basic cleaning - every six months

- ▶ First carry out the weekly basic cleaning.
- ▶ Work up a foam from a mild, luke-warm soap solution (e.g. from a mild-action detergent).
- ▶ Apply the foam evenly over all the covers using a soft, slightly damp sponge.
- ▶ Wait until the freshly cleaned covers are completely dry.



## Care/cleaning of micro-fibre covers



### Caution:

The covers must be completely dry before they are sat on again. Permanent pressure marks could otherwise form.

- ▶ Brush along the nap of the fabric using a soft brush, without applying pressure.

### Removing stains



### Caution:

Remove dirt as soon as possible to prevent permanent stains or damage to the covers.



### Caution:

Do not use cleaning products containing solvents (e.g. petroleum ether, acetone, alcohol, etc.). This would damage the micro-fibre covers and equipment parts made of plastic or foam beyond repair.

- ▶ Remove as much dirt as possible using a lint-free cloth.

- ▶ Using a soft sponge, work a mild, lukewarm soap solution into the dirt in circular movements from the outside in. Apply light pressure when doing this.



### Note:

Always clean up the dirt from the outside in to prevent it from being dispersed in the fabric.



### Caution:

Do not use cleaning products containing solvents (e.g. petroleum ether, acetone, alcohol, etc.). This would damage the micro-fibre covers and equipment parts made of plastic or foam beyond repair.

- ▶ Mop up the soap solution using a clean, soft sponge.
- ▶ Wait until the freshly cleaned areas are completely dry.



### Caution:

The covers must be completely dry before they are sat on again. Permanent pressure marks could otherwise form.

- ▶ Finally, brush the cover and the cleaned areas using a soft brush along the nap of the fabric.



### Caution:

If in any doubt, use a professional textile cleaning company.

## Care/cleaning of leather covers

### Care/cleaning of leather covers



#### **Danger.**

Observe the general information/safety precautions in this section.



#### **Caution:**

To avoid leaving chalky outlines or water marks, use only distilled water for cleaning.



#### **Caution:**

Minimise exposure to direct sunlight to avoid colour fading.



#### **Note:**

Regular care and basic cleaning help to maintain the value and high-quality appearance of leather covers, as well as the long-term durability and suppleness of the leather. For this reason, carry out basic cleaning at least four times a year. Carry out basic cleaning more regularly if necessary, depending on use and the level of dirt.

### Basic cleaning - every quarter

- ▶ Remove coarse dirt with a very soft brush or a vacuum cleaner.



#### **Caution:**

Do not use a sharp-edged vacuuming nozzle or too hard a brush, otherwise you could damage the leather beyond repair.

- ▶ Moisten a soft, lint-free cloth with distilled water.
- ▶ Wipe leather upholstery down with a damp cloth.



#### **Caution:**

Do not use a cloth or sponge with a rough surface as this could scratch the leather upholstery or damage it beyond repair.



#### **Caution:**

To prevent the formation of permanent pressure marks, leather upholstery has to be dried off fully before subsequent use.

### Removing stains



#### **Caution:**

Remove dirt as soon as possible to prevent permanent stains or damage to the covers.

- ▶ Remove as much dirt as possible using a soft, lint-free cloth.
- ▶ Gently work a mild, lukewarm soap solution into the dirty area.
- ▶ Then wipe the dirt up using a clean cloth.

- ▶ Remove the soap solution used using clean, distilled water.

**Note:**

All dirt and soap residues must be completely removed. If in doubt, rinse again.

**Note:**

To avoid the formation of outlines, not only should the mark be treated but also the wider area around it.

- ▶ Then dry the cleaned areas using a hairdryer set to medium heat, keeping it moving in a circular motion at a distance of 30 cm to 40 cm.

**Caution:**

The leather covers must be completely dry before they are sat on again. Permanent pressure marks could otherwise form.

**Caution:**

If in any doubt, use a professional leather cleaning company.

**Leather care products****Note:**

Information about suitable leather care products can be obtained from your OMNIplus Service Partner or from a professional leather cleaning company.





|   |    |
|---|----|
| Driver's area overview .....                                | 76 |
| Switches on the left section of the instrument panel .....  | 77 |
| Switches on the right section of the instrument panel ..... | 82 |
| Switches below the driver's window .....                    | 84 |
| Instrument cluster .....                                    | 86 |
| DTCO tachograph .....                                       | 88 |
| Tachograph (display) .....                                  | 90 |
| Door pushbuttons in the driver's area .....                 | 90 |
| Tools and emergency equipment .....                         | 91 |
| Location of the fire extinguishers .....                    | 92 |
| Location of the first-aid kits .....                        | 92 |
| Tow bar location (option) .....                             | 93 |
| Location of spare mirror (option) .....                     | 93 |
| Reversing aid display in the exterior mirror (option) ..... | 93 |
| Emergency hammer (option) .....                             | 95 |
| Driver's rest area .....                                    | 96 |

### Table of contents

|   |            |
|---|------------|
| <b>Windscreen washer reservoir</b> .....  | <b>98</b>  |
| <b>Seat belt reminder display</b> .....   | <b>99</b>  |
| <b>Exterior flaps on the TRAVEGO M / L</b> .....                                    | <b>100</b> |
| <b>Layout and function description: fire extinguishing system (option)</b> .....    | <b>101</b> |
| <b>Operating and malfunction displays: fire extinguishing system (option)</b> ..... | <b>102</b> |



## Driver's area overview

Driver's area overview





## Switches on the left section of the instrument panel

| No. | Description   | Page |
|-----|---|------|
| 1   | Switches on the left section of the instrument panel                            | 77   |
| 2   | Instrument cluster  | 86   |
| 3   | Switches on the right section of the instrument panel                           | 82   |
| 4   | Navigation system display screen  |      |
| 5   | Tachograph  |      |
| 6   | Control panel for audio/video system in driver's area and passenger compartment |      |
| 7   | Heating/ventilation/air-conditioning (HVAC) control panel                       |      |

| No. | Description   | Page |
|-----|---|------|
| 8   | Steering column switch for transmission shift system and continuous brake (engine brake and retarder) | 114  |
| 9   | Steering column switch for light and wiper functions  | 112  |
| 10  | Right-hand steering wheel buttons   |      |
| 11  | Left-hand steering wheel buttons  |      |
| 12  | Parking brake and emergency release device  | 159  |
| 13  | Switches below the driver's window  | 84   |

## Switches on the left section of the instrument panel







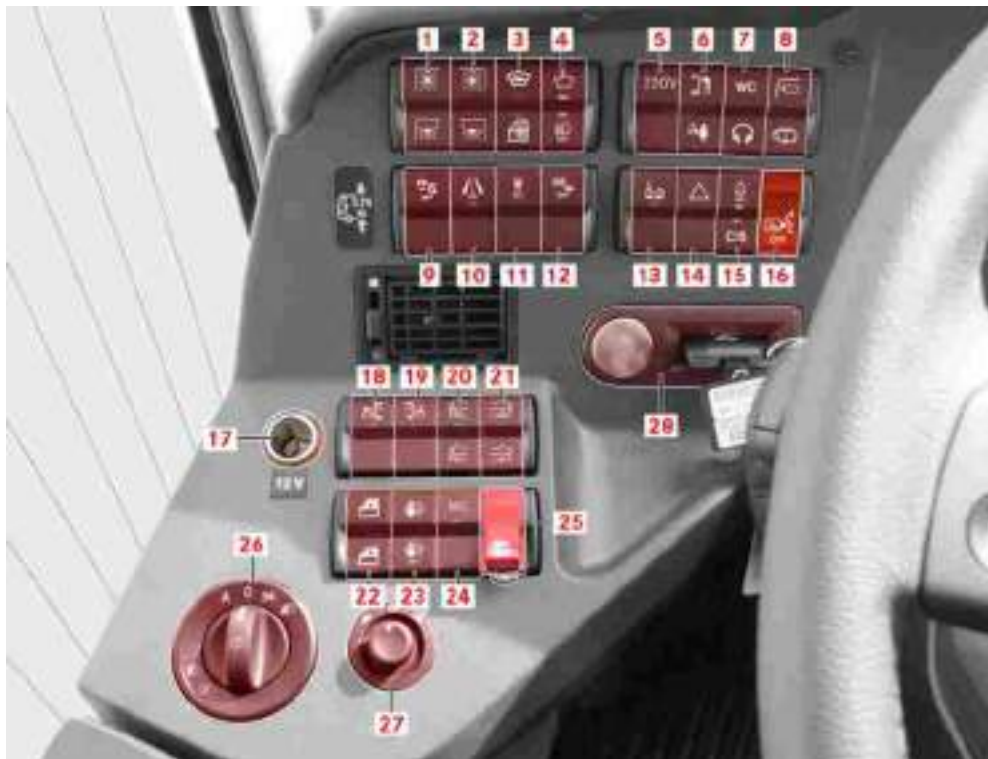









**Note:**

The overview shows the maximum utilisation of the instrument panel with switches in their designated position. To accommodate the customisation requirements of the customer, the switches may have been assigned to different positions on the instrument panel.







### Switches on the left section of the instrument panel



## Switches on the left section of the instrument panel

| No. | Description   | Page | No. | Description   | Page | No. | Description  | Page |
|-----|---|------|-----|---|------|-----|--|------|
| 1   |  Windscreen roller sunblind pushbutton   | 171  | 7   |  Lavatory/multi-channel audio system enabling switch (option)                      | 173  | 12  |  Switch for deactivating pedal-activated continuous braking       | 174  |
| 2   |  Co-driver's roller sunblind pushbutton  | 171  | 8   |  Video system/reversing camera washer system switch (option)                       | 173  | 13  |  Axle load transfer switch (3-axle buses only)                    | 175  |
| 3   |  Pushbutton for windscreen heating (option)/driver's window heating+mirror heating | 171  | 9   |  Active Brake Assist OFF pushbutton (option)                                       | 173  | 14  |  "School bus operation" pushbutton (option)                       | 175  |
| 4   |  Pushbutton for upper wiper (option)/headlamp cleaning system                      | 172  | 10  |  Lane assistant warning system pushbutton (option)                                 | 174  | 15  |  Reverse warning signal (option)/air horn ON                      | 175  |
| 5   |  Inverter (option)   | 172  | 11  |  Acceleration skid control (ASR) OFF/Electronic Stability Program (ESP) pushbutton | 174  | 16  |  Emergency switch for alcohol interlock                           | 176  |
| 6   |  Kitchenette/attendant call enabling pushbutton (option)                           | 172  |     |   |      | 17  | Socket   |      |
|     |   |      |     |   |      | 18  |  Central locking pushbutton for the left-side luggage compartment | 176  |

## Switches on the left section of the instrument panel

| No. | Description   | Page | No. | Description             | Page |
|-----|---|------|-----|-------------------------|------|
| 19  |  Central locking pushbutton for the right-side luggage compartment | 176  | 26  | Rotary light switch     | 109  |
| 20  |  Front roof hatch pushbutton - air in/air out                      | 177  | 27  | Mirror adjuster         |      |
| 21  |  Rear roof hatch pushbutton - air in/air out                       | 177  | 28  | Ignition starter switch |      |
| 22  |  Driver's power window pushbutton                                  | 178  |     |                         |      |
| 23  |  Diesel particulate filter (DPF) regeneration                      | 178  |     |                         |      |
| 24  |  Driver's seat microphone switch (option)                          | 179  |     |                         |      |
| 25  |  Bus stop brake emergency release switch (option)                  | 179  |     |                         |      |









### Switches on the right section of the instrument panel

Switches on the right section of the instrument panel



## Switches on the right section of the instrument panel

| No. | Description   | Page |
|-----|---|------|
| 29  |  Door I pushbutton                         | 179  |
| 30  |  Door II pushbutton                        | 180  |
| 31  |  Emergency valve reset pushbutton (option) | 180  |
| 32  | Not assigned  |      |
| 33  |  Hazard warning lamps pushbutton           | 180  |
| 34  | Not assigned  |      |
| 35  |  Normal level/kneeling pushbutton          | 181  |
| 36  |  Pushbutton for raising/lowering the bus   | 181  |
| 37  |  Hillholder and bus stop brake             | 181  |





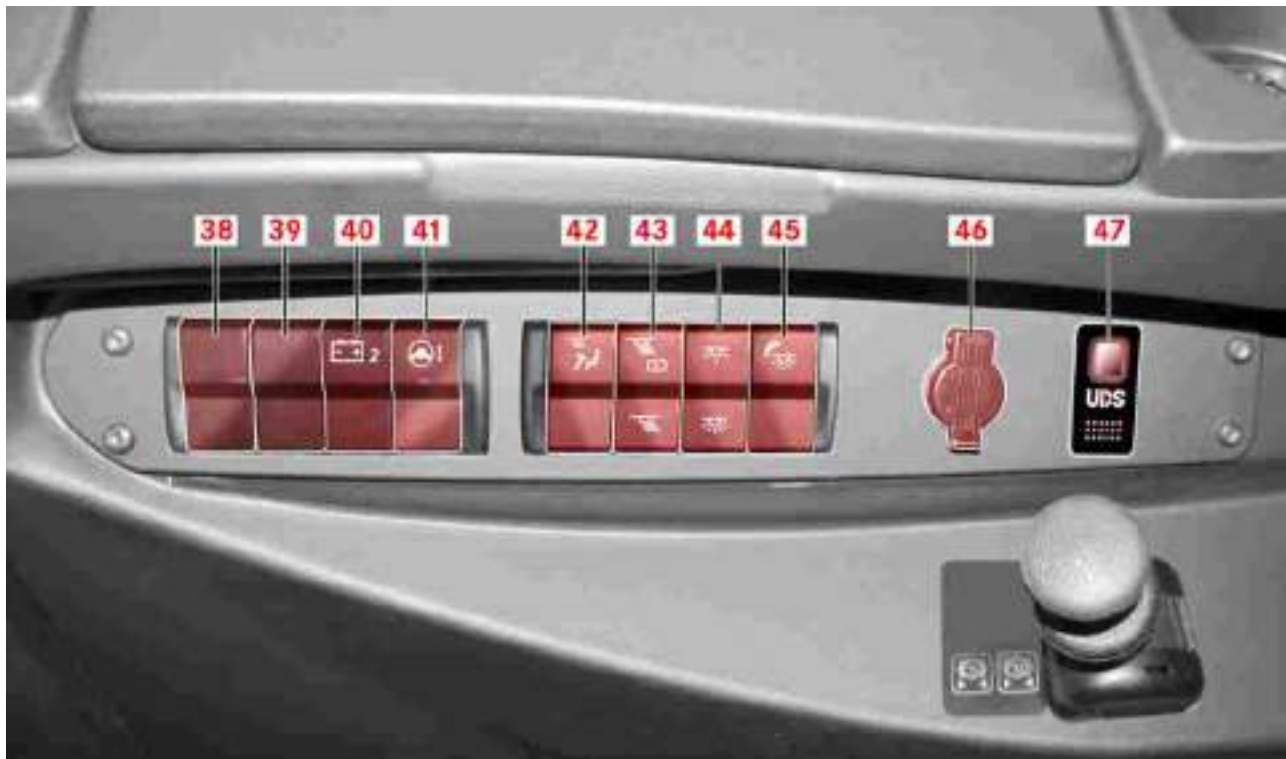

### Switches below the driver's window

#### Switches below the driver's window





## Switches below the driver's window

| No. | Description  | Page |
|-----|--|------|
| 38  | Not assigned   |      |
| 39  | Not assigned   |      |
| 40  |  Auxiliary batteries pushbutton (option)              | 182  |
| 41  |  Steering column adjustment switch                    | 183  |
| 42  |  Driver's area lighting switch                        | 183  |
| 43  |  Reading lamps switch                                 | 183  |
| 44  |  Passenger-compartment lighting switch positions I+II | 184  |
| 45  |  Night lighting switch                                | 185  |
| 46  | Socket   |      |

| No. | Description   | Page |
|-----|---|------|
| 47  |  ADR pushbutton (option) | 185  |

## Instrument cluster

### Instrument cluster



| No. | Description  | Page | No. | Description                                       | Page | No. | Description  | Page |
|-----|--|------|-----|---|------|-----|--|------|
| 1   | ASR traction control indicator lamp                |      | 7   | Brake pad wear indicator lamp                     |      | 16  | Dipped-beam indicator lamp   |      |
| 2   | ABS indicator lamp                                 |      | 8   | Braking request indicator lamp                    |      | 17  | Brake system malfunction warning lamp  |      |
| 3   | ESP indicator lamp                                 |      | 9   | Fuel reserve level indicator lamp                 |      | 18  | Indicator lamp for diesel particulate filter regeneration active                         |      |
| 4   | Indicator lamp for the left-hand turn signals      |      | 10  | Emission-relevant fault malfunction display (MIL) |      | 19  | Warning lamp for diesel particulate filter load state/malfunction                        |      |
| 4a  | Indicator lamp for trailer left-hand turn signals  |      | 11  | Tachograph indicator lamp                         |      | 20  | Indicator lamp for presence of emission-related fault/prompt for manual DPF regeneration |      |
| 5   | Indicator lamp for the right-hand turn signals     |      | 12  | Active Brake Assist deactivated indicator lamp    |      | 21  | AdBlue® reserve level indicator lamp   |      |
| 5a  | Indicator lamp for trailer right-hand turn signals |      | 13  | ESP OFF indicator lamp                            |      |     |  |      |
| 6   | Tyre pressure warning lamp                         |      | 14  | Main-beam indicator lamp                          |      |     |  |      |
|     |  |      | 15  | Indicator lamp for parking brake applied          |      |     |  |      |

### DTCO tachograph

#### DTCO tachograph

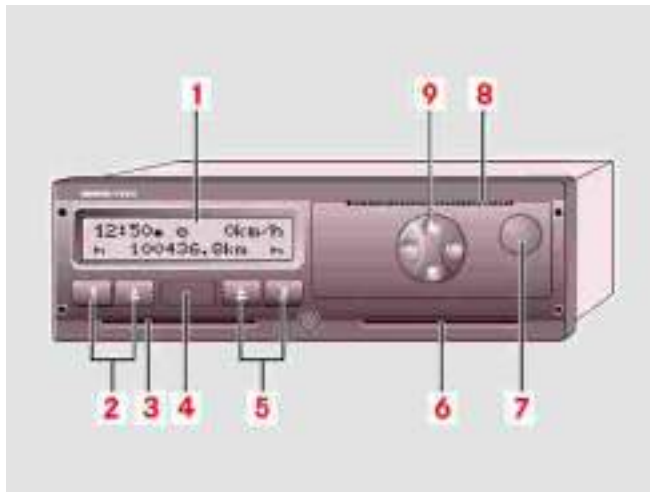

- 1 Display: Different displays appear depending on the operating state of the bus.
  - ▷ See Display variants in the manufacturer's operating instructions.
- 2 Key panel, driver 1
 

 **Note:**  
Activity button, driver 1/card slot ejector button, driver 1
- 3 Card slot, driver 1: Driver 1, the current driver of the bus, inserts his driver card into card slot 1.
 

 **Note:**  
Insert the card with the chip facing upwards in the direction of the printed arrow.
- 4 Download/calibration interface: There is an interface under the cover. This interface can only be enabled with an inserted company card, control card or workshop card.
  - ▷ For details, see “Access rights for tachograph cards” in the manufacturer's operating instructions.
- 5 Key panel, driver 2
 

 **Note:**  
Activity button, driver 2/card slot ejector button, driver 2
- 6 Card slot, driver 2: Driver 2, who is not currently driving the bus, inserts his driver card into card slot 2.
 

 **Note:**  
Insert the card with the chip facing upwards in the direction of the printed arrow.
- 7 Printer drawer release button: This button is used to release the printer drawer, for example, for inserting a new roll of paper.
- 8 Tear-off edge
- 9 Menu buttons: Buttons for entering, displaying or printing data.
  - ▷ See “Calling up menu functions” in the manufacturer's operating instructions.

### Tachograph (display)

#### Tachograph (display)



M68.00-0458-71

#### 1 Speed display

#### 2 Warning lamp

When lit, this means that there is a message on the tachograph display screen. Driver symbol + fault code = operator error (card missing or inserted incorrectly). Fault code = system fault (contact a service centre).

#### 3 Display for total distance

#### 4 Display for trip distance

#### Door pushbuttons in the driver's area

Door pushbuttons for front right door (1) and centre right door (2) with integrated warning lamp and emergency valve reset pushbutton (3) (locator lighting also ON when Lights ON).



#### Note:

The warning lamp lights up when: - a door is open - a door is not fully closed (door not latched).



#### Note:

The warning lamp flashes in the event of - operating pressure too low (depressurised bus door) - door malfunction.

## Tools and emergency equipment

**Danger.**

If the display flashes, correct operation of the doors is no longer guaranteed. Do not move the bus if a warning lamp in the door pushbutton lights up or a yellow or red alert is shown on the display screen. If you attempt to do so, a red alert will appear on the display screen and the warning buzzer will sound.

**Note:**

A door cannot be operated unless the ignition starter switch is ON, the bus is stationary and the doors have been unlocked.

**Note:**

After an emergency valve has been operated, the door system cannot be restored to normal operation until emergency valve reset pushbutton (3) has been pressed.

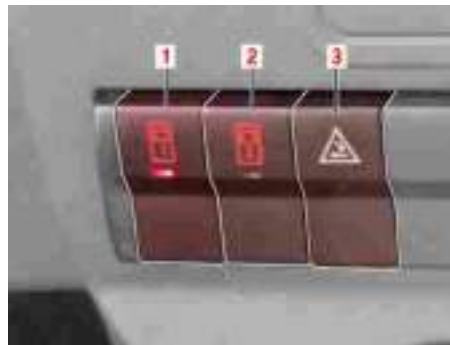

M68.00-0578-71

**Tools and emergency equipment**

The vehicle tool kit and emergency equipment are located in the stowage compartment over the front axle on the right-hand side and behind the front flap (spare wheel cover).

Tools and emergency equipment:

- Warning triangle
- Hydraulic jack 10 t maximum load with base board (observe the manufacturer's operating instructions).
- Hydraulic jack 5 t maximum load (3-axle buses only) (observe the manufacturer's operating instructions).
- Ramp
- Wheel chock
- WAF 27/32 socket spanner
- Towing pin/towing coupling
- Crank for emergency operation of the driver's window
- Tool box (containing spare bulbs, valve connector, tyre inflation hose, torch and warning lamp etc.) (option)

### Location of the fire extinguishers

#### Location of the fire extinguishers



M86\_00-0133-01

A portable fire extinguisher (1) is located under the first row of seats on the left when viewed in the direction of travel.



#### Note:

Check the inspection plate and have the fire extinguisher tested by an authorised person if necessary.

#### Location of the first-aid kits



M86\_00-0274-71

There are first-aid kits in the luggage rack on the left- and right-hand side above the first row of seats.



#### Note:

Look for symbol (1).



#### Note:

Check the expiry dates of the contents of the first-aid kits every year, and replace them if necessary.

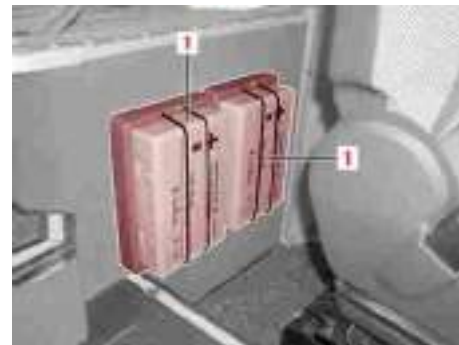

M86\_00-0310-71

First-aid kits (1) may also be fitted behind the driver's seat.



**Tow bar location (option)**

The tow bar is bolted into the left-side luggage compartment to the rear of the front axle.

**Location of spare mirror (option)**

M88\_00-0009-01

There is a replacement mirror (1) in the left-side luggage compartment immediately to the rear of the front axle. It is designed to act as an emergency mirror only.

Loosen 4 screws (2) to enable you to remove the mirror.

▷ For “Removing the exterior mirror/fitting the emergency mirror”, refer to the “Practical advice” section of the Operating Instructions.

**Reversing aid display in the exterior mirror (option)**

M82\_00-0006-01

The reversing aid informs the driver of the distance to an obstacle. The reversing aid is activated automatically when reverse gear is engaged. There are three differently coloured LEDs in the left and right-hand sides at the bottom of the rear-view mirror behind the mirror glass which act as indicators. The mirror is transparent at this point.

### Reversing aid display in the exterior mirror (option)



#### **Danger.**

The reversing aid is only a tool designed to help you and it may not detect all obstacles. It does not relieve you of the necessity to pay attention. You are responsible for safety at all times and must continue to pay attention to the immediate surroundings when parking and manoeuvring. You will otherwise endanger yourself and others.



#### **Danger.**

Make sure that there are no persons or animals in the area in which you are manoeuvring. You could otherwise injure them.

#### Function of the reversing aid



M82\_00-0006-01

When reverse gear is engaged, green LED (1) lights up when there is a distance of 1.5 metres to the obstacle, yellow LED (2) at 80 cm and red LED (3) at 40 cm. When reverse gear is engaged and the system is fully functional, the red LED must light up for approximately 0.5 seconds. If the red LED flashes twice every 6 seconds, there is a malfunction in the system.



#### **Danger.**

The reversing aid assists the driver when parking but does not release him from the legal obligation to drive carefully (ensuring safety when reversing, observe the legal requirements in all countries concerned). The reversing aid function is not possible when operating the bus with a trailer or ski holder.



#### **Caution:**

Make sure when parking that you pay attention to objects above and below the sensors, e.g. flower pots or trailer tow bars. The reversing aid does not detect such objects at close range. You could otherwise damage the bus or the objects.



#### **Note:**

Sources of ultrasonic radiation, e.g. the compressed-air brake system or a pneumatic hammer, could adversely affect the reversing aid.

## Emergency hammer (option)

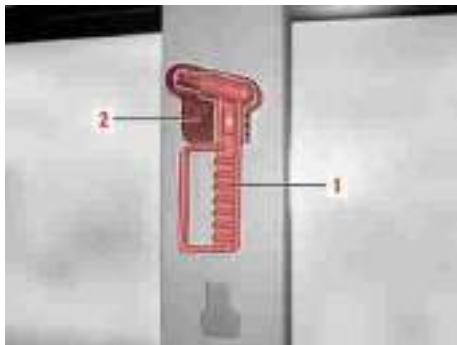

M86\_00-0304-71

- Pull out emergency hammer (1) with the tamper-evident seal from bracket (2).

The emergency hammer is ready for use.



If the vehicle is equipped with an electronic anti-theft alarm system (option), this symbol appears on the display screen in conjunction with

a yellow alert when an emergency hammer has been removed.

### Driver's rest area

#### Driver's rest area

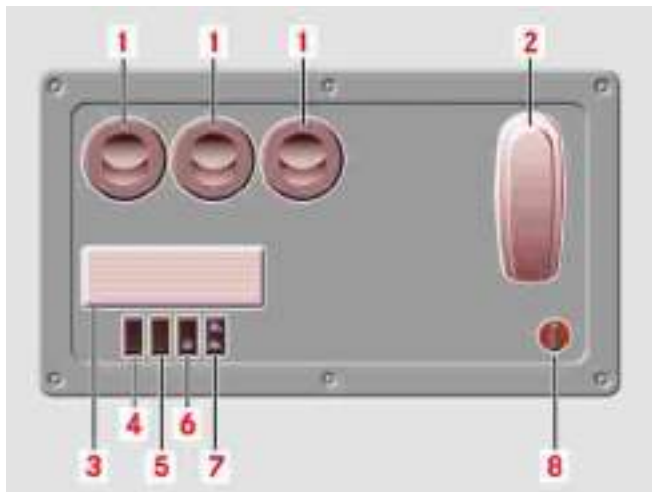

- 1 Ventilation flaps
- 2 Intercom (connection to the driver)
- 3 Interior light
- 4 Not assigned
- 5 Not assigned
- 6 Air-conditioning switch (option)
- 7 Switch for ventilation blower speed I and II
- 8 Heating controller

### Windscreen washer reservoir

Windscreen washer reservoir

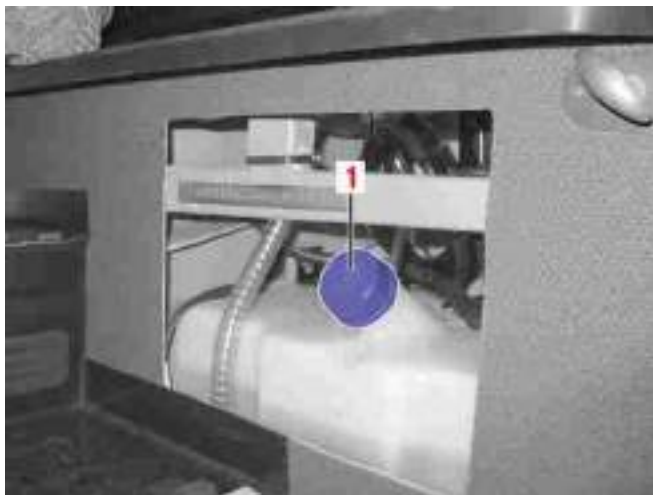

- 1 Windscreen washer fluid reservoir filler opening (1)

**Note:**

The windscreen washer reservoir is accessible through a flap in the front right doorway. To remove the cover, loosen the quick-release locks anti-clockwise.

**Seat belt reminder display****Seat belt reminder display**

M54\_00-0978-01

With the ignition switched on and the doors closed, “Fasten seat belts” symbol (1) on the right-hand side at the front of the passenger compartment is displayed for 5 minutes after the bus has pulled away.

## Exterior flaps on the TRAVEGO M / L

Exterior flaps on the TRAVEGO M / L

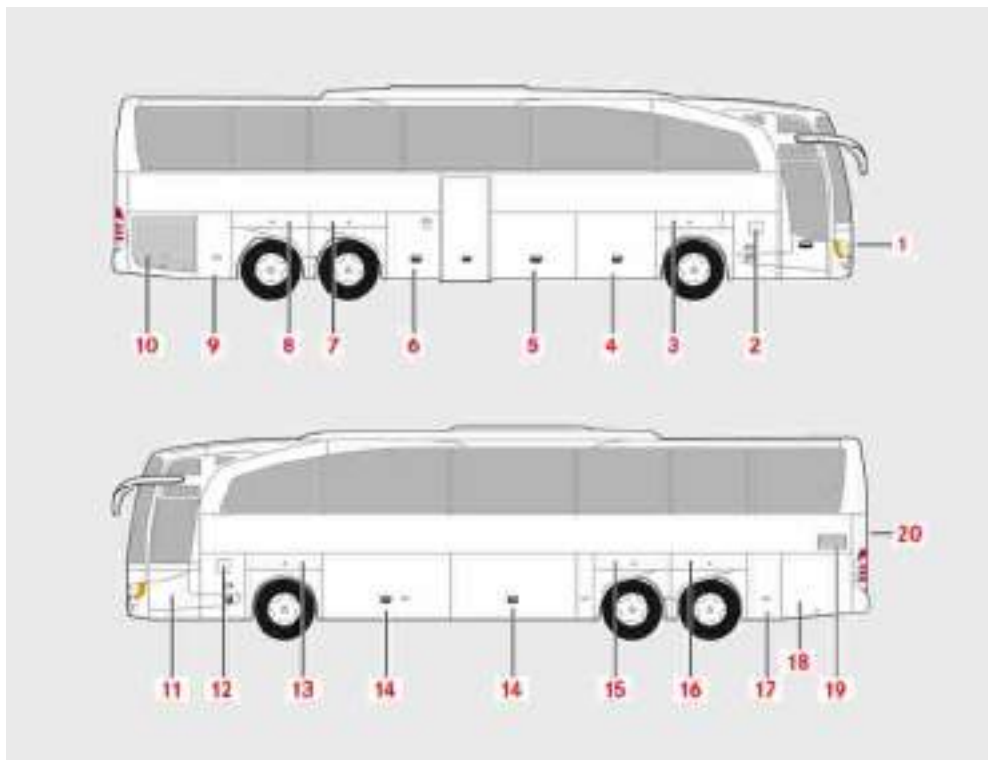



## Layout and function description: fire extinguishing system (option)

|    |   |    |                    |
|----|---|----|--------------------|
| 1  | Spare wheel   | 20 | Engine compartment |
| 2  | Fuel tank, AdBlue® tank                                   |    |                    |
| 3  | Stowage compartment,<br>vehicle tool kit                  |    |                    |
| 4  | Luggage compartment                                       |    |                    |
| 5  | Luggage compartment/lavatory                              |    |                    |
| 6  | Luggage compartment/multi-purpose room/driver's rest area |    |                    |
| 7  | Vehicle tool kit  |    |                    |
| 8  | Auxiliary switch panel                                    |    |                    |
| 9  | Luggage compartment                                       |    |                    |
| 10 | Radiator  |    |                    |
| 11 | Main switch panel   |    |                    |
| 12 | Fuel tank   |    |                    |
| 13 | Stowage compartment                                       |    |                    |
| 14 | Luggage compartment                                       |    |                    |
| 15 | Stowage compartment                                       |    |                    |
| 16 | Batteries/battery isolating switch                        |    |                    |
| 17 | Exhaust system  |    |                    |
| 18 | Exhaust system  |    |                    |
| 19 | Air cleaner   |    |                    |

**Layout and function description:  
fire extinguishing system (option)**

The fire extinguishing system comprises the following five main components: Extinguisher tank, detection agent tank, detection line, extinguisher lines and extinguisher nozzles.

A trigger valve is fitted to the extinguisher tank. The trigger valve is connected to the detection agent tank by the detection line. The pressure (approximately 24 bar) of the detection agent tank therefore acts on the trigger valve. Extinguisher lines are connected to the extinguisher tank. The extinguisher lines in the engine compartment are equipped with extinguisher nozzles. The detection agent tank is filled with nitrogen gas and Glysantin.

In the event of a fire in the engine compartment or in the installation area of the auxiliary heating unit, the detection line melts and the nitrogen gas and Glysantin escape. The drop in pressure in the detection line depressurises the trigger valve on the extinguisher

### Operating and malfunction displays: fire extinguishing system (option)

tank and thus triggers the extinguishing process. The highly pressurised extinguishing fluid (approximately 100 bar) is forced out of the extinguisher tank into the extinguisher lines. The extinguishing fluid is sprayed from the extinguisher nozzles as a fine mist. The fire extinguishing system is monitored by two pressure switches. A warning message alerts the driver to the fact that the fire extinguishing system has been triggered.



#### Caution:

Due to the way in which the system works, there is a time delay between the start of the fire and the melting of the detection line. The possibility of fire damage cannot therefore be completely ruled out even if the fire extinguishing system is functioning correctly.



#### Danger.

Under unfavourable circumstances, the fire extinguishing system may not be able to extinguish the fire completely and permanently. Further measures will then be required as necessary.

### Operating and malfunction displays: fire extinguishing system (option)

#### Fire extinguishing system malfunction



If the fire extinguishing system fails or if there is a malfunction, or even a blaze that goes unnoticed, this icon appears on the display screen in conjunction with a yellow warning level malfunction.



#### Caution:

If a yellow warning level malfunction is displayed, it is permissible to drive on carefully but the bus should be checked by an OMNIplus Service Partner at the earliest opportunity.

**Fire extinguishing system triggered**

A triggering of the fire extinguishing system (e.g. due to a fire in the engine compartment or in the auxiliary heating unit installation space) is indicated by this icon on the display screen in conjunction with a red warning level malfunction. A warning signal sounds.



**Danger.**

Risk of accident. If this alert is displayed, bring the vehicle to an immediate halt (road and traffic conditions permitting), open all the doors and urge the passengers to disembark. Then operate the master safety switch and apply the parking brake. Disembark and implement or arrange further measures as necessary.



|  |     |
|--|-----|
| Ignition lock .....  | 108 |
| Adjustable steering column .....   | 109 |
| Exterior lighting .....  | 109 |
| Steering column switch for light and wiper functions .....   | 112 |
| Steering column switch for transmission shift system and continuous brake (engine brake and retarder)<br>..... | 114 |
| Steering wheel buttons .....   | 115 |
| Overview of steering wheel buttons and display screen .....  | 116 |
| Left-hand steering wheel buttons .....   | 118 |
| Right-hand steering wheel buttons .....  | 120 |
| Display screen .....   | 122 |
| Display screen (description) .....   | 123 |
| Main menu screen display .....   | 124 |
| Menu structure .....   | 124 |
| Display screen menu control logic .....  | 143 |
| Event notifications .....  | 145 |

### Table of contents

|   |            |
|---|------------|
| <b>Resetting the trip meter</b> .....   | <b>146</b> |
| <b>Volume adjustment</b> .....  | <b>147</b> |
| <b>Radio volume adjustment</b> .....  | <b>147</b> |
| <b>Adjusting the volume of the passenger-compartment on-board PA system</b> .....                   | <b>149</b> |
| <b>Adjusting the volume of the intercom in the driver's rest area/on-board kitchenette</b> .....    | <b>149</b> |
| <b>Telephone volume adjustment</b> .....  | <b>150</b> |
| <b>Initiating an outgoing call using the driver's rest area/kitchenette intercom (option)</b> ..... | <b>151</b> |
| <b>Initiating an outgoing call using the driver's area intercom (option)</b> .....                  | <b>152</b> |
| <b>Answering an incoming call using the driver's area intercom (option)</b> .....                   | <b>154</b> |
| <b>Mobile phone Bluetooth link</b> .....  | <b>155</b> |
| <b>Initiating an outgoing call using a mobile phone (option)</b> .....                              | <b>156</b> |
| <b>Answering an incoming call using a mobile phone (option)</b> .....                               | <b>158</b> |
| <b>Parking brake and emergency release device</b> .....   | <b>159</b> |
| <b>Air suspension safety precautions</b> .....  | <b>160</b> |
| <b>Raising/lowering the bus</b> .....   | <b>161</b> |
| <b>Normal level</b> .....   | <b>162</b> |

|   |            |
|---|------------|
| <b>Activating/deactivating axle load transfer for trailing axle (3-axle buses only) .....</b> | <b>163</b> |
| <b>Activating/deactivating the bus stop brake .....</b>                                       | <b>164</b> |
| <b>Important information on the steering system .....</b>                                     | <b>165</b> |
| <b>Turning the steering wheel when the bus is stationary .....</b>                            | <b>165</b> |
| <b>Switching on the panorama camera (option) .....</b>  | <b>166</b> |

## Ignition lock

### Ignition lock

The ignition switch consists of a slot (2) for accepting the key (3) and a two-stage start/stop button (1). To switch on the ignition, insert key (3) into slot (2) as far as the stop. Insert key (3) into the slot with the marque logo facing upwards.



### Danger.

Whenever you disembark, even for a short time, always remove the key so that the bus cannot be started by children or other unauthorised persons.



### Note:

Gently pressing start/stop button (1) no further than the first pressure point activates "ignition position 1" (= radio position): Selected consumer units can be switched on.



### Note:

Gently pressing start/stop button (1) again and no further than the first pressure point activates "ignition position 2" (= ignition ON): In this position, it is possible to switch on additional functions, e.g. headlamps.



### Note:

Pressing start/stop button (1) through the pressure point starts the engine.



### Note:

When start/stop button (1) is pressed again, the engine switches off.



### Note:

With the engine switched off, it is possible to switch off the ignition by removing the key (or by pressing the start/stop button repeatedly to the 1st pressure point).



M54.00-1840-71



### Adjustable steering column

Release the steering column using switch (1). The red LED in the switch lights up.



**Danger.**

Do not make adjustments unless the bus is stationary. Re-engage the steering column after you have adjusted the steering wheel to a suitable position. To do this, press switch (1). The red LED in the switch goes out.



M46.00-0201-71



**Danger.**

After the adjustable steering column has been adjusted, the driver must check that all instruments and indicator lamps are still visible.

### Exterior lighting

#### Rotary light switch



M54\_00-1365-71

At engine start, the daytime driving lights also switch on.

- A Automatic headlamp feature/daytime driving lights switched on
- 0 Daytime driving lights switched on
- 1 Side lamps
- 2 Headlamps
- 3 Front foglamps (pull switch to 1st detent)

### Exterior lighting

- 4 Rear foglamp (pull switch to 2nd detent)

#### Automatic headlamp feature

The side lamps, dipped-beam headlamps and licence plate lamps switch on and off in response to changes in the brightness of ambient light. When the key is in position 1 in the ignition lock, the side lamps switch on and off automatically. When the engine is running, the dipped-beam headlamps, side lamps and licence plate lamps switch on and off automatically.



#### Danger.

If bright light strikes the sensor when the rotary light switch is in position (A), the headlamps may switch off temporarily or, in fog, the lights may not switch on automatically at all. As this would pose a risk of accident, it is prudent to turn the rotary light switch to position (2) in dark or foggy conditions. The automatic headlamp feature is merely an aid. Correct use of the vehicle lighting is always the driver's responsibility.



#### Danger.

If it becomes dark or foggy, turn the rotary light switch from (A) to (2) without delay. Otherwise, there would be a risk of accident if the headlights were to switch off temporarily.

#### Daytime driving lights

As soon as the engine is switched on, the side lamps, the dipped-beam headlamps and the licence plate lamps switch on automatically.



#### Note:

Turning the rotary light switch to any position other than (A) or (0) switches on the lights assigned to the selected switch position.

▷ For notes on switching the daytime driving lights on and off, refer to the "Driver's area controls" section of the Operating Instructions.

#### Headlamps

Dipped-beam or main-beam headlamps (depending on the steering column switch position), side lamps and licence plate lamps switched on.



#### Note:

Make sure that the key is in the ignition lock or that the engine is running.

#### Front foglamps

In addition to the side lamps, dipped-beam headlamps or main-beam headlamps, the front foglamps switch on provided the ignition starter switch has been switched to ON. Indicator lamp (3.1) lights up.



#### Danger.

In foggy conditions, pull the rotary light switch out to the first detent (3).

**Danger.**

If it becomes foggy, turn the rotary light switch from (A) to (2) without delay. Otherwise, there would be a risk of accident if the headlights were to switch off temporarily.

**Note:**

When the rotary light switch is in position (A), neither the front foglamps nor the rear foglamp can be switched on.

**Rear foglamp**

The rear foglamp is switched on in addition to the front foglamps. Indicator lamp (4.1) lights up. When a trailer or skibox is connected, the rear foglamp on the towing vehicle is disabled and only the rear foglamp connected via the trailer socket is enabled.

**Danger.**

In foggy conditions, pull the rotary light switch out to the second detent (4).

**Danger.**

If it becomes foggy, turn the rotary light switch from (A) to (2) without delay. Otherwise, there would be a risk of accident if the headlights were to switch off temporarily.

**Note:**

When the rotary light switch is in position (A), neither the front foglamps nor the rear foglamp can be switched on.

**Note:**

In respect of rear foglamp operation, the legal requirements of the country concerned must be observed.

**Cornering lamps**

Special front foglamps that illuminate the side of the bend towards which the vehicle is being steered. The cornering lamps are activated only when it is dark, at a road speed of below 40 km/h and if the front foglamps have not been switched on. The cornering lamps are switched on either by the turn signals or by the steering angle sensor.

**Note:**

Make sure that the engine is running and that the dipped-beam headlamps are switched on (rotary light switch in position (A) or (2)).

**Note:**

Switch on the turn signals. The cornering lamp on the same side as the active turn signals switches on and it remains switched on even if the steering wheel is turned in the opposite direction.

### Steering column switch for light and wiper functions



#### Note:

Turn the steering wheel in the desired direction. In forward gear: The cornering lamp on the inside of the bend comes on. In reverse gear: The cornering lamp on the outside of the bend comes on.



#### Note:

To switch off the cornering lamp, switch off the turn signals or turn the steering wheel back towards the straight-ahead position until the turn signals switch off automatically.

### Courtesy lighting

In dark conditions, the foglamps switch on to provide courtesy lighting whenever the complete vehicle is unlocked or locked. The courtesy lighting illuminates the area around the bus so that people can find their way more easily.



#### Note:

The switch-off delay for the courtesy lighting can be adjusted from 0 - 60 seconds in increments of 5 seconds. At the end of the courtesy lighting switch-off delay, the courtesy lighting switches off automatically.

▷ Select a courtesy lighting switch-off delay and refer to the “Driver's area controls” section of the Operating Instructions.

### Steering column switch for light and wiper functions

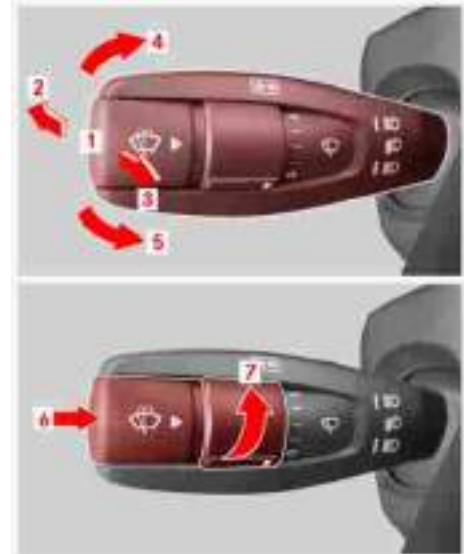

M54.00-1898-72

- 1 Dipped-beam: Main-beam headlamps OFF (with dipped-beam headlamps switched on)

## Steering column switch for light and wiper functions

- 2 Main-beam: Main-beam headlamps ON (with dipped-beam headlamps switched on)
- 3 Headlamp flasher: Pull the stalk upwards
- 4 Indicate right with automatic reset: Press the switch stalk beyond the pressure point until it engages in position.

**Note:**

One-touch indicators for a lane change: Press the switch stalk only briefly (not beyond the pressure point). The turn signals flash five times.

- 5 Indicate left with automatic reset: Press the switch stalk beyond the pressure point until it engages in position.

**Note:**

One-touch indicators for a lane change: Press the switch stalk only briefly (not beyond the pressure point). The turn signals flash five times.

- 6 Wipe and wash: Press the sleeve on the switch stalk inwards towards the steering column. With windscreen wipers switched off = windscreen wipe and wash
- 7 Windscreen wipers: Turn the sleeve on the switch stalk: Speed 0 = OFF. Speed. . . . = Slow intermittent wipe or wiping with rain sensor. Speed.....= Rapid intermittent wipe or wiping with rain sensor. Speed I = Slow continuous wiping. Speed II = Rapid continuous wiping.

**Caution:**

Switch stalk position. . . . : If the rain sensor is active, the windscreen wiper may switch on inadvertently if dirt were to settle on the windscreen in dry weather. The windscreen wiper blades or the windscreen itself could then be damaged by dry wiping. Keep the windscreen wipers switched off in dry weather.

**Note:**

Switch stalk position . . . . : If the rain sensor is active, the wiping frequency is adjusted automatically as appropriate to how heavy it is raining.

### Steering column switch for transmission shift system and continuous brake (engine brake and retarder)



#### Note:

Frost function: At low temperatures, the rain sensor does not switch on the windscreen wipers until the windscreen has been scraped clear.



#### Note:

The rain sensor detects sea spray.



#### Note:

For notes on setting the wipe interval/rain sensor sensitivity, refer to the "Driver's area controls" section of the Operating Instructions.

#### Steering column switch for transmission shift system and continuous brake (engine brake and retarder)

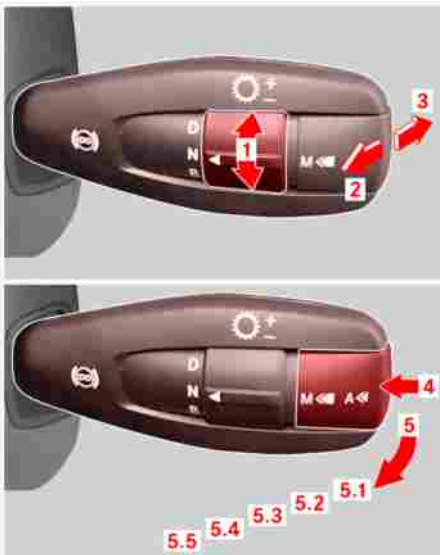

M54.00-1897-72

- 1 To select the driving direction
- 2 Manual upshift
- 3 Manual downshift

- 4 To select automatic mode/  
change shift program
- 5 To activate continuous brake
  - 5.1 Continuous brake stage 1
  - 5.2 Continuous brake stage 2
  - 5.3 Continuous brake stage 3
  - 5.4 Continuous brake stage 4
  - 5.5 Continuous brake stage 5

**Steering wheel buttons**

The steering wheel buttons are used to control what is displayed on the display screen. They can also be used to change various settings.

## Driver's area controls

### Overview of steering wheel buttons and display screen

Overview of steering wheel buttons and display screen





### Overview of steering wheel buttons and display screen

- 1 Display screen
- 2 Left-hand steering wheel buttons
- 3 Right-hand steering wheel buttons
- 4 Signal horn

## Driver's area controls

### Left-hand steering wheel buttons

#### Left-hand steering wheel buttons





To store/display favourite menu windows



Previous main menu

*In the input window, to select the previous value or reduce a value*



Next main menu

*In the input window, to select the next value, to increase or reset a value*



Previous menu window

*In the input window, to go up one menu line*



Next menu window

*In the input window, to go down one menu line*



To open and close input window/to acknowledge event window



Audio/telephone volume up



Audio/telephone volume down

## Driver's area controls

### Right-hand steering wheel buttons

#### Right-hand steering wheel buttons





To display telephone menu window

*To make/accept a call*



To end/reject a call



To select the variable speed limiter (TempoSet)



To select cruise control/distance cruise control



Speed/speed limiter

*To activate and set current speed/limit speed, to increase set speed/limit speed.*



To activate and resume stored speed/limit speed, to reduce set speed/limit speed



To deactivate the variable speed limiter (TempoSet)/cruise control/distance cruise control



Driving systems menu window

*Idling speed increase/to set specified distance (distance cruise control)/to set speed tolerance (cruise control/distance cruise control)*

## Display screen

Display screen



The display screen comprises five basic elements:

1 Display field for main menus



**Note:**

Display field (1) shows the main menus. The active main menu appears in light blue.

2 Title bar



**Note:**

In title bar (2), the name of the active menu window is displayed.

3 Display field for submenus



**Note:**

Display field (3) shows the submenus. The active submenu appears in light blue.

4 Display area



**Note:**

In display area (4), the on-board computer shows the menu or event window. An event window is displayed automatically and contains a message or information about a malfunction.

5 Status area



**Note:**

In addition to the displayed event window, an indicator lamp may also light up in status area (5) in the instrument cluster. If you are able to acknowledge the event window by pressing the "OK" button on the steering wheel, the event window will close when you do so.

### Display screen (description)

The display screen is activated whenever the ignition key is inserted and the start/stop button is pressed to the first pressure point. The display screen is a status indicator for showing operating and malfunction information. Additionally, it can be used to view information from the Integrated Diagnostics System (IDS).



**Note:**

If a malfunction occurs, this will be displayed only if the ignition key is inserted and the start/stop button has been pressed to the first pressure point.

## Main menu screen display

### Main menu screen display

#### Display of main menus



M68.00-0466-71

The title bar comprises 6 different displays. The active main menu appears in light blue.

### 1: Trip information

---

### 2: Driver assistance

---

### 3: Vehicle

---

### 4: Notifications

---

### 5: Information

---

### 6: Settings

---

### Menu structure



#### Note:

The menu structure comprises 6 main menus with various submenus.



#### Note:

The active main menu and submenu appear in light blue.



### 1. "Tourinformation" (Trip information) main menu



M68.00-0476-71

"Tourinformation" (Trip information) main menu (1) displays all available information on speed, time of day, driving and rest times, travelled distances and outside temperature.

### "Geschwindigkeit, Zeit, Temperatur" (Speed, time, temperature) submenu



M68.00-0474-71

In the "Geschwindigkeit, Zeit, Temperatur" (Speed, time, temperature) submenu, all available information on speed, time and temperature is displayed.

#### 1: Vehicle speed

Displays the current driving speed

#### 2: Total distance

Displays the total overall distance travelled by the vehicle.

#### 3: Trip distance

Displays the distance travelled since the last reset.

#### 4: Time

Displays the current time.

#### 5: Outside temperature

Displays the current outside temperature.

## Menu structure

### "Tachograf" submenu



M68.00-0475-71

The "Tachograf" submenu displays all available information on driving times and rest times.

#### 1: Driver

Name of the driver

#### 2: Driving time

Displays the current driving time

#### 3: Rest time

Displays the current rest time

### "Reichweite" (Range) submenu



M68.00-0607-71

The "Reichweite" (Range) submenu displays all available information on fuel, AdBlue® range and current fuel consumption.



#### Note:

Fuel consumption (3) is displayed in l/100 km or in l/h (with the vehicle stationary).

### 1: Fuel range remaining

Displays the fuel range remaining

### 2: AdBlue® range

Displays the AdBlue® range remaining

### 3: Fuel consumption

Displays the current fuel consumption in l/100 km

### "Ab Start - Gesamt" (After start - Total) submenu



M68.00-0478-71

In the "Ab Start - Gesamt" (After start - Total) submenu, all available information

on distance travelled, fuel consumption and time is displayed.

### **1: Distance travelled**

Displays the distance travelled since the start

### **2: Driving time**

Displays the driving time since the start

### **3: Average speed**

Displays the average speed since the start

### **4: Average consumption**

Displays the average fuel consumption since the start

### **“Ab Reset - Gesamt” (After reset - Total) submenu**



M68.00-0605-71

In the “Ab Reset - Gesamt” (After reset - Total) submenu, all available information on distance travelled, fuel consumption and time since the last total reset is displayed.

### **1: “OK”**

Reset the indication display using the “OK” button on the steering wheel.

### **2: Distance travelled**

Displays the distance travelled since total reset

### **3: Driving time**

Displays the driving time since total reset

### **4: Average speed**

Displays the average speed since total reset

### **5: Average consumption**

Displays the average fuel consumption since total reset

## Menu structure

### “Ab Reset - Fahren” (After reset - Drive) submenu



M68.00-0606-71

In the “Ab Reset - Fahren” (After reset - Drive) submenu, all available information on distance travelled, fuel consumption and time since the last in-drive reset is displayed.

#### 1: “OK”

Reset the indication display using the “OK” button on the steering wheel.

#### 2: Distance travelled

Displays the distance travelled since in-drive reset

#### 3: Driving time

Displays the driving time since in-drive reset

#### 4: Average speed

Displays the average speed since in-drive reset

#### 5: Average consumption

Displays the average fuel consumption since in-drive reset

### 2. “Fahrerassistenz” (Driver assistance) main menu



M68.00-0477-71

In “Fahrerassistenz” (Driver assistance) main menu (2), the driver can view information from all available driving systems and the navigation system (option).

**“Assistenz” (Assistance) submenu**

M68.00-0482-71

The “Assistenz” (Assistance) submenu displays all available information on vehicle-to-vehicle distance, speed difference and lane holding.

**i Note:**

As the distance from the vehicle in front decreases, the colour of the display changes from white to yellow and then to red.

**i Note:**

As the distance from the lane marking decreases, the colour of the lane marking changes from white to yellow and then to red.

**1: Speed in km/h**

Speed of vehicle in front

**2: Distance in m**

Distance from vehicle in front

**“Navigation” submenu (option)**

M68.00-0483-71

The “Navigation” submenu displays all available information on route guidance.

**1: Destination**

Displays the destination road name

**2: Driving time remaining**

Displays the time to destination in hours and minutes

**3: Location**

Displays the current road

## Menu structure

### 4: Distance

Displays the distance remaining in kilometres

### 5: Bus symbol

Road is passable for the bus.

### “Ersatzfahrbetrieb” (Failsafe mode) submenu (option)



M68.00-0484-71

In the “Ersatzfahrbetrieb” (Failsafe mode) submenu, transmission shift system failsafe mode can be activated and displayed.



#### Note:

Refer also to “Operating the GO 250-8 PowerShift failsafe mode with the steering wheel keypad” in the “Transmission shift systems” section.

### 1: To activate transmission shift system failsafe mode

It is possible to activate failsafe mode by pressing the OK button on the steering wheel.

### Parking brake query



M68.00-0485-71

If the parking brake is applied, confirm with right arrow button (2).

## Failsafe mode selection



M68.00-0486-71

Select the desired failsafe driving mode.

## 3. "Fahrzeug" (Vehicle) main menu



M68.00-0487-71

The "Fahrzeug" (Vehicle) main menu displays all available information on flaps, doors and operating pressures, temperatures and voltages.

## "Türen und Klappen" (Doors and flaps) submenu



M68.00-0487-71

The "Türen und Klappen" (Doors and flaps) submenu shows whether doors and flaps are open or closed.

**Note:**

Engine compartment flap (1) is open.

## Menu structure

### “Luftdruck” (Air pressure) submenu



M68.00-0488-71

The “Vorratsdruck” (Reservoir pressure) submenu displays the various air supply pressures.

**1: Circuit 1 supply pressure**

**2: Circuit 2 supply pressure**

**3: Auxiliary consumers supply pressure**

### “Kühlmittel” (Coolant) submenu



M68.00-0489-71

The "Kühlmitteltemperatur" (Coolant temperature) submenu displays the current coolant temperature (1).

### “Motor” (Engine) submenu



M68.00-0490-71

The “Motorölstand, Betriebsstunden” (Engine oil level, operating hours) submenu displays engine oil level (1) and operating hours (2) of the engine.



## "Batterie" (Battery) submenu



M68.00-0491-71

The "Batteriespannung" (Battery voltage) submenu displays the current battery voltage (1).

## "Reifen" (Tyres) submenu (option)



M68.00-0492-71

The "Reifen" (Tyres) submenu displays the pressure of each tyre. In addition, the nominal pressure, the temperature in the tyre and the charge state of the sensor battery can also be displayed.

**i** Note:

If the pressure in a tyre is too low or the temperature is too high, the colour of the display changes from white to yellow or red.

**i** Note:

As a consequence of tolerances and temperature compensation, tyres with the same inflation pressure may be displayed with different colours (white, yellow or red).

**i** Note:

Press "OK" button (1) to display the nominal pressure, temperature and battery charge state.

## Menu structure

### Display for axle 1



M68.00-0493-71

In this display window, the most important information about the tyre is displayed.



#### Note:

For further information, refer to “On-screen tyre pressure monitor” in the “Practical advice” section.

### 1: Display for axle 1

### 2: Displays the nominal pressure

3: Displays the actual pressure, temperature and state of charge of the tyre pressure sensor in the front left wheel.

4: Displays the actual pressure, temperature and state of charge of the tyre pressure sensor in the front right wheel.

### 4. “Meldungen” (Notifications) main menu

In the “Meldungen” (Notifications) menu, all active/stored operating notifications, fault alerts and events are displayed. In addition, it is possible to query diagnostics and maintenance information.

### “Betriebsmeldungen” (Operating notifications) submenu



M68.00-0494-71

In the “Betriebsmeldungen” (Operating notifications) submenu, all active operating notifications are displayed, e.g. air recirculation mode (1).



#### Note:

Refer also to the “Practical advice” section.

### “Fehlermeldungen” (Fault alerts) submenu



M68.00-0599-71

In the “Fehlermeldungen” (Fault alerts) submenu, all active/stored fault alerts are displayed, e.g. “Door emergency valve at door 1 operated” (1), “Fuel gauge malfunction” (2), “Air cleaner clogged” (3).



#### Note:

Red alerts, yellow alerts and service notifications (grey) are displayed here.



#### Note:

Refer also to the “Practical advice” section.

### “Ereignisse” (Events) submenu

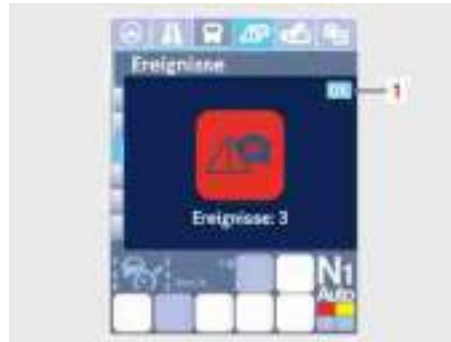

M68.00-0496-71

The “Ereignisse” (Events) submenu displays all stored events



#### Note:

Press “OK” button (1) on the steering wheel to display the events individually.

### Events display



M68.00-0497-71

Oil level too low

## Menu structure



### Note:

Press the “arrow” button on the steering wheel to display further information (1) about the events.

### “Diagnose” (Diagnostics) submenu



M68.00-0498-71

Using “OK” button (1) in the “Diagnose” (Diagnostics) submenu, it is possible to display the fault codes and view the instructions associated with them.

### “Textmeldung” (Text message) submenu (option)

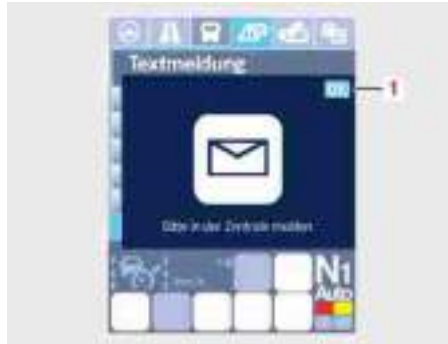

M68.00-0500-71

In the “Textmeldung” (Text message) submenu, it is possible to view worded notifications. Pressing “OK” button (1) enables further texts to be displayed.

### “Telefon” (Telephone) submenu (option)



M68.00-0501-71

The “Telefon” (Telephone) submenu offers a number of functions. These are described later in this section.

### 5. “Information” main menu

In the “Information” main menu, it is possible to call up and view information on the telephone system (option) and video system (option).

**“Video” submenu (option)**

M68.00-0502-71

The “Video” submenu is used to display the images recorded by various cameras fitted in the bus.

**6. “Einstellungen” (Settings) main menu**

In the “Einstellungen” (Settings) main menu, it is possible to change settings for the clock, language and driver assistance systems (bus and basic settings).

**“Datum/Uhrzeit” (Date/time) submenu**

M68.00-0503-71

The “Datum/Uhrzeit” (Date/time) submenu displays the current date and time

**“Einstellmenü” (Settings menu) submenu**

M68.00-0504-71

In this “Einstellmenü” (Settings menu) submenu, it is possible to change bus settings and basic settings.

## Menu structure

### “Buseinstellungen” (Bus settings) submenu



M68.00-0608-71

In the “Buseinstellungen” (Bus settings) submenu, it is possible to set the rain sensor (1), the display illumination dimming level (2), the courtesy lighting switch-off delay (3) and the volume of the turn signal buzzer (4).



#### Note:

Select the desired option using the selection buttons on the left-hand side of the steering wheel.

### “Regensensor” (Rain sensor) submenu



M68.00-0611-71

To change the rain sensor sensitivity.



#### Note:

Using arrow buttons (2) and (3), set the desired value and confirm with OK (1).

### Dimmung (Dimming level)



M68.00-0506-71

To change the dimming level.

**Note:**

Using arrow buttons (2) and (3), set the desired dimming level for the display illumination in the cockpit and confirm with OK (1).

**Nachleuchtzeit (Switch-off delay)**

M68.00-0507-71

To set the switch-off delay for the courtesy lighting.

**Note:**

Using arrow buttons (2) and (3), set the desired switch-off delay and confirm with OK (1).

**Blinkersummer (Turn signal buzzer)**

M68.00-0508-71

To set the volume of the turn signal buzzer.

**Note:**

Using arrow buttons (2) and (3), set the desired volume and confirm with OK (1).

**“Grundeinstellungen” (Basic settings) submenu**

M68.00-0509-71

In the “Grundeinstellungen” (Basic settings) submenu, it is possible to select the preferred units of measurement and time format.

## Menu structure



### Note:

Make your selection using arrow button (2).

### Grundeinstellungen Einheiten (Basic settings, Units)



M68.00-0510-71

In the “Einheiten” (Units) submenu, it is possible to choose between various units of measurement.



### Note:

Make your selection using arrow button (2).

### Select “Grundeinstellungen, Einheiten” (Basic settings, Units)



M68.00-0516-71

Select your preferred display.



### Note:

Confirm with ok button (2). Then go back using arrow button (1).

### Select “Grundeinstellungen, Uhrzeit” (Basic settings, Time format)



M68.00-0517-71

Select the preferred format.



**Note:**

Confirm with OK button (2). Then go back using arrow button (1).

**“Systeme” (Systems) submenu**

M68.00-0523-71

The “Systeme” (Systems) submenu enables you to activate various systems.

**Note:**

Pressing “OK” button (1) on the steering wheel opens the settings menu for various systems.

**To activate Attention Assist**

M68.00-0524-71

Activate Attention Assist by pressing “OK” button (2) on the steering wheel.

**Note:**

If tick (3) is displayed, this means that the system is activated.

**Note:**

Go back to the submenu using arrow button (1).

**Note:**

Attention Assist evaluates a range of indicators used to recognise the driver's transition from alertness to drowsiness.

## Menu structure

### To activate creep mode.



M68.00-0526-71

Activate or deactivate creep mode (manoeuvring mode) by pressing “OK” button (2) on the steering wheel.

**i** **Note:**

If tick (3) is displayed, this means that creep mode is activated.

**i** **Note:**

Go back to the submenu using arrow button (1).

**i** **Note:**

The creep function is available at all times after an engine start and is activated after the vehicle has pulled away for the first time. The creep function enables the vehicle to creep forwards independently when the service brake is released with the engine idling without the driver having to use the accelerator pedal. The vehicle crawls along at idling speed until the driver uses the service brake to stop or until the creep function is deactivated/cancelled.

**!** **Caution:**

The creep function must not be used in stop-and-go traffic on the motorway under any circumstances.

### “Sprache” (Language) submenu



M68.00-0527-71

In the “Sprache” (Language) submenu, it is possible to select the preferred language setting.

**i** **Note:**

Pressing “OK” button (1) on the steering wheel opens the settings menu for various languages.

## To select a language



M68.00-0528-71

Navigate to the preferred language. When it is highlighted blue, confirm the selection using the “OK” button on the steering wheel.

**Note:**

Country flag (2) for the selected language is also displayed.

## Display screen menu control logic

## Display screen sequence at start-up



M68.00-0487-71

After the ignition starter switch has been switched to ON, the first display to appear on the display screen is the standby screen with the marque logo. If a fault occurs at this point, a corresponding fault alert will be displayed. If no fault occurs, the system checks whether there are any event notifications present. If there are, the associated pop-up window opens and the driver has to acknowledge the event notifications in

order of their urgency. The system then verifies whether the supply pressures for the various compressed-air circuits are at acceptable levels. If so, the bus graphic in the “Fahrzeug” (Vehicle) main menu is then displayed. However, if a supply pressure is too low, which may be the case if the vehicle has been parked up for a long period, a pop-up window displaying the supply pressures for the various compressed-air circuits opens. The pop-up window closes automatically as soon as the necessary operating pressure is reached. If the driver acknowledges the pop-up window using the buttons on the steering wheel before the correct pressure has been reached, another pop-up window opens and displays a red alert informing the driver once more that the operating pressure is still too low. If the necessary operating pressure is now reached, or if the driver acknowledges the red alert, the bus graphic in the “Betriebsmeldungen” (Operating notifications) main menu will be displayed.

## Display screen menu control logic



### Note:

The operating pressure can be monitored in main menu 3 "Fahrzeug" (Vehicle), sub-menu 2 "Vorratsdruck" (Air pressure).

### Menu selection

The driver can select menus manually using the buttons on the steering wheel. In addition, provided specific conditions are fulfilled, the menus alternate between the "Fahrzeug" (Vehicle) and "Fahrerassistenz" (Driver assistance) main menus automatically so that the driver is always provided with all the necessary information while the bus is stationary or in motion without the driver having to select these menus manually.

### Screen display with bus stationary



M68.00-0487-71

The driver is shown the "Fahrzeug" (Vehicle) main menu if any of the doors or flaps are open. The menu is also displayed immediately after the ignition is switched on. If the driver changes menu manually, the "Fahrerassistenz" (Driver assistance) main menu will no longer appear automatically while the vehicle is in motion.



### Note:

The "Fahrzeug" (Vehicle) main menu continues to be displayed during slow-speed manoeuvres if luggage compartment flaps are still open.

### Screen display while the bus is in motion



M68.00-0483-71

As soon as a minimum speed is exceeded and all doors and flaps have been closed, the view automatically changes to the "Navigation" submenu or, if the vehicle is equipped with a navigation system, the "Assistenz" (Assist-

ance) submenu. The view reverts to the "Fahrzeug" (Vehicle) main menu as soon as one of the doors is opened.

### Event notifications

#### Red alert

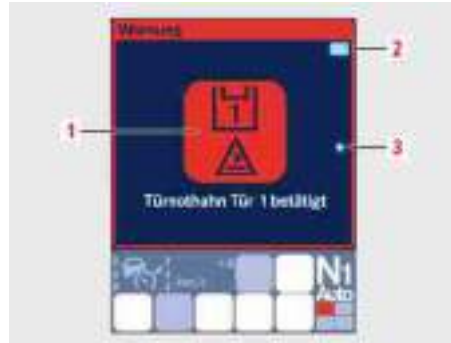

M54.00-2002-71

In the event of a red alert, a symbol accompanied by a description (1) of the affected vehicle system appears in the pop-up window. A signal also sounds. It is also possible to view further information relating to the red alert by pressing right arrow button (3) on the steering wheel. The driver is able to acknowledge red alerts using "OK" button (2) on the steering wheel, but not until the vehicle has been brought to a halt and the parking brake has been applied. The

red alert remains active. Acknowledging the alert simply closes the pop-up window. For as long as the alert remains active, it continues to be displayed in the "Ereignisse" (Events) menu.



**Danger.**

In the event of a red warning level malfunction, the bus must be stopped immediately (traffic conditions permitting) and an OMNIplus Service Partner must be notified.

### Resetting the trip meter

#### Yellow alert



M47.00-0137-71

In the event of a yellow alert, a symbol for the affected vehicle system appears in pop-up window (1) with explanatory text below. It is also possible to view further information relating to the yellow alert by pressing right arrow button (3) on the steering wheel. In addition, yellow status indicator (4) lights up on the display screen. Each yellow alert has to be acknowledged manually by the driver using “OK” button (2) on the steering wheel. Pop-up window (1) closes when the alert is acknowledged. For as long as the alert remains active, it contin-

ues to be displayed in the “Ereignisse” (Events) menu (4).



#### Caution:

In the event of a yellow warning level malfunction, it is permissible to drive on carefully but the bus should be checked by an OMNIplus Service Partner at the earliest opportunity.

#### Resetting the trip meter



M68.00-0534-71

- ▶ In main menu 1 (Trip info), select the “Geschwindigkeit” (Speed) submenu.
- ▶ Press the “OK” button.
- ▶ Select “Tageskilometeranzeige zurücksetzen?” (Reset trip meter?) and confirm with “ja” (yes).

### Volume adjustment

- ▶ The “Lautstärke” (Volume) pop-up window enables the driver to adjust the volume for the currently active audio source.
- ▶ There must be no pop-up window currently on the screen (exception: pop-up window for a call in progress).
- ▶ Press the plus or minus button on the steering wheel.

The pop-up window for the currently active audio source opens.

#### **i** Note:

If the active audio source is changed while the pop-up window is open, the content of the pop-up window changes accordingly.

- ▶ To adjust the volume, press the plus or minus button on the steering wheel.

#### **i** Note:

If the plus or minus button is pressed and held, the volume increases or decreases until the button is released.

#### **i** Note:

As the change of volume comes into effect immediately, the driver is given an audible acknowledgement at the new volume.

### Radio volume adjustment

- ▶ The radio is the active audio source.
- ▶ Press the plus or minus button on the steering wheel.



M68.00-0535-71

“Lautstärke Fahrer” (Driver's volume) pop-up window (1) of the radio system opens.

### Radio volume adjustment



#### Note:

The driver can close the pop-up window at any time using the “left arrow” button on the steering wheel.



#### Note:

The pop-up window closes automatically if no button is pressed within 10 seconds.

- ▶ To adjust the volume, press the minus or plus button on the steering wheel.



#### Note:

If the plus or minus button is pressed and held, the volume increases or decreases until the button is released.



#### Note:

As the change of volume comes into effect immediately, the driver is given an audible acknowledgement at the new volume.



M68.00-0612-71

- ▶ Using the arrow buttons on the steering wheel, it is possible to toggle between driver and passenger compartment.



#### Note:

Only the volume of the currently selected audio zone is adjusted when the minus or plus button is pressed.



## Adjusting the volume of the passenger-compartment on-board PA system

### Adjusting the volume of the passenger-compartment on-board PA system

- ▶ Switch on the on-board PA system using the “PA system” switch on the instrument panel.



- ▶ Press the plus or minus button on the steering wheel.



M68.00-0613-71

The “Lautstärke Fahrgastraum”  
(Volume, Passenger compartment)

pop-up window of the PA system opens.

#### Note:

The pop-up window closes automatically if no button is pressed within 10 seconds.

- ▶ To adjust the volume, press the minus or plus button on the steering wheel.

#### Note:

If the plus or minus button is pressed and held, the volume increases or decreases until the button is released.

#### Note:

As the change of volume comes into effect immediately, the driver is given an audible acknowledgement at the new volume.

### Adjusting the volume of the intercom in the driver's rest area/ on-board kitchenette



M82.00-0139-71

- ▶ While a call is in progress, press the plus or minus button on the steering wheel until the desired volume is set.

#### Note:

The change of volume comes into effect immediately.

### Telephone volume adjustment



#### Note:

The volume in effect at the time the ignition is switched off is retained when the ignition is switched back on (if between 30 and 40). If a lower volume than this was set, the volume will be set to 30 when the ignition is switched back on. If a higher volume was set, the volume will be set to 40 when the ignition is switched back on.

- ▶ If both outer buttons on the intercom handset are pressed simultaneously, a brief alert tone will sound. It is then possible to decrease or increase the volume using the left or right outer button respectively.

- ▶ At the call station in the driver's rest area, it is possible to block incoming calls. Pressing and holding the relevant button is followed by an alert tone indicating that incoming calls will now be blocked. The block on incoming calls will be cancelled if the same button is pressed and held again or if the ignition is switched off and on again.

### Telephone volume adjustment

- ▶ While a call is in progress, press the plus or minus button on the steering wheel.



M68.00-0542-71

The “Lautstärke Cockpit” (Volume, Cockpit) pop-up window opens.



#### Note:

The driver can close the pop-up window at any time using the “left arrow” button on the steering wheel.

## Initiating an outgoing call using the driver's rest area/kitchenette intercom (option)

**Note:**

The pop-up window closes automatically if no button is pressed within 3 seconds.

- ▶ To adjust the volume, press “-” button (1) or “+” button (2) on the steering wheel repeatedly until the desired volume is set.

**Note:**

As the change of volume comes into effect immediately, the driver is given an audible acknowledgement at the new volume.

- ▶ To end the call, press the “hang up the telephone” button on the steering wheel.

## Initiating an outgoing call using the driver's rest area/kitchenette intercom (option)



M82\_00-0107-71

- ▶ Pick up the handset and press the desired button.

**Note:**

F = Driver

**Note:**

K = Kitchenette

**Note:**

R = Driver's rest area

**Note:**

D = Upper deck (double-decker buses only)

An attempt is made to establish a call connection with the desired intercom handset.

### Initiating an outgoing call using the driver's area intercom (option)

#### Initiating an outgoing call using the driver's area intercom (option)



M68.00-0539-71

- ▶ Press the “pick up the telephone” button on the steering wheel.

The “Telefon” (Telephone) pop-up window opens.



#### Note:

The driver can close the pop-up window at any time using the “left arrow” button on the steering wheel.

- ▶ To select the intercom, press the minus or plus button repeatedly until “Gegensprechanlage” (Intercom) is highlighted in dark blue.
- ▶ Using the arrow buttons on the steering wheel, select the desired intercom handset in the bus.



M68.00-0540-71

- ▶ An attempt is made to establish a call connection with the selected handset when the “pick up the telephone” button on the steering wheel is pressed.

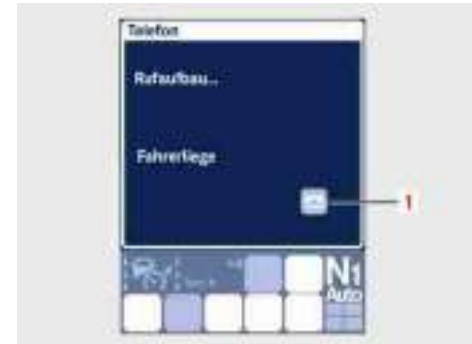

M68.00-0548-71

- ▶ While the call is being established, the message “Rufaufbau” (Connecting call) and the selected handset are displayed in the “Bordtelefon” (Intercom) pop-up window.



#### Note:

Using the “left arrow” button on the steering wheel, the driver is able to close the pop-up window without the connection attempt being interrupted.

## Initiating an outgoing call using the driver's area intercom (option)

**Note:**

It is possible to cancel the connection attempt using the “hang up the telephone” button on the steering wheel.

**Note:**

If the call is not answered after five rings, the connection attempt is cancelled and the last viewed screen display reappears.



M68.00-0541-71

- ▶ While a call is in progress, “Telefon” (Telephone) and the connected party are displayed in the pop-up window. The driver can end the call by pressing the “hang up the telephone” button on the steering wheel.

**Note:**

Using the “left arrow” button on the steering wheel, the driver is able to close the pop-up window without ending the call. This frees up the display screen and other menus can now be displayed. For as long as the call remains active, the driver can restore the pop-up window by pressing the “pick up the telephone” button on the steering wheel.

### Answering an incoming call using the driver's area intercom (option)

#### Answering an incoming call using the driver's area intercom (option)



M68.00-0539-71

- ▶ Whenever a connection attempt is received by the intercom, the “Telefon” (Telephone) pop-up window opens and the driver is informed which handset in the bus initiated the call.
- ▶ Using the “left arrow” button on the steering wheel, the driver is able to close the pop-up window and thereby reject the call.

- ▶ The driver can answer the call by pressing “pick up the telephone” button (2) on the steering wheel.



M68.00-0540-71

- ▶ While a call is in progress, “Telefon” (Telephone) and the connected party (1) are displayed in the pop-up window. The driver can end the call by pressing the “hang up the telephone” button on the steering wheel.



#### Note:

Using the “left arrow” button on the steering wheel, the driver is able to close the pop-up window without ending the call. This frees up the display screen and other menus can now be displayed. For as long as the call remains active, the driver can restore the pop-up window by pressing the “pick up the telephone” button on the steering wheel.

## Mobile phone Bluetooth link

## Mobile phone Bluetooth link

**Note:**

To be able to use the hands-free function, a Bluetooth link must have been established between the mobile phone and the radio unit.

**Note:**

Trouble-free operation of the Bluetooth hands-free system cannot always be guaranteed with mobile phone software versions that are older or more recent than the approved version because software version modifications implemented by mobile phone manufacturers also affect the functions supported by the mobile phone.

**Note:**

A list of compatible mobile phones is available at your OMNIplus Service Partner.

- ▶ Establish a Bluetooth link between the mobile phone and the radio unit in the bus.

**Note:**

The ignition starter switch must be ON.

- ▶ If this is the first time that an attempt has been made to connect a particular mobile phone, proceed as follows:
- ▶ Press the "Menu" button on the radio.
- ▶ Press the rotary knob on the right.

**Note:**

Bluetooth must be active.

- ▶ Select "BT-Pair" by turning the rotary knob.

**Note:**

Confirm by pressing the knob.

- ▶ A code will then be displayed on the radio display screen.
- ▶ Find the Bluetooth connection option on the mobile phone.

**Note:**

The procedure for establishing a Bluetooth link varies by the mobile phone model used. Please refer to the user guide for the mobile phone concerned.

- ▶ Enter the code given by the radio and confirm.

### Initiating an outgoing call using a mobile phone (option)



#### Note:

The data transfer may take up to five minutes (depending on the manufacturer). No screen display appears during the registration process.



#### Note:

The Bluetooth connection attempt will fail if either the ignition or the mobile phone are switched off or if the mobile phone is out of range. If the ignition and the mobile phone are switched on again or if the mobile phone is brought back into range, the telephone control unit in the bus will search for the most recent Bluetooth link.



#### Note:

If a different mobile phone is used, it is necessary to establish a new Bluetooth link. The telephone control unit in the bus always searches for the most recent Bluetooth link. It is not possible to have two mobile phones connected at once.



#### Note:

To reduce the amount of electromagnetic radiation emitted by the mobile phone, the phone should always be inserted into a compatible cradle.

### Initiating an outgoing call using a mobile phone (option)



M68.00-0545-71

- ▶ Press the “pick up the telephone” button on the steering wheel.

The “Telefon” (Telephone) pop-up window opens.



#### Note:

The driver can close the pop-up window at any time using the “left arrow” button on the steering wheel.



## Initiating an outgoing call using a mobile phone (option)

- ▶ Using the minus button or plus button, it is possible to scroll through the phone book to the desired letter.

**i** **Note:**

If the bus is equipped only with a mobile phone (no intercom), no bus symbol will be displayed, only the phone book.

The title bar displays “Telefon” (Telephone) and, with certain models, the strength of the mobile phone signal (depending on the manufacturer).

- ▶ Using the arrow buttons on the steering wheel, it is possible to select the phone book entry you wish to call.
- ▶ An attempt is made to establish a call connection with this phone book entry when the “pick up the telephone” button on the steering wheel is pressed.



M68.00-0546-71

- ▶ The name of the selected phone book entry is displayed while the call is being established.

**i** **Note:**

It may be some time before a mobile phone connection can be established.



M68.00-0544-71

- ▶ While a call is in progress, “Rufbau...” (Connecting call...) and “Unbekannter Name” (Unknown name) are displayed in the “Telefon” (Telephone) pop-up window. The driver can end the call by pressing “hang up the telephone” button (1) on the steering wheel.

### Answering an incoming call using a mobile phone (option)



#### Note:

Using the “left arrow” button on the steering wheel, the driver is able to close the pop-up window without the connection attempt being interrupted.



#### Note:

At present, some mobile phone models do not support the transfer of mobile phone numbers. As a result, the name assigned to the destination phone number cannot be displayed. “unbekannter Name” (unknown name) and the telephone number are therefore displayed instead.

### Answering an incoming call using a mobile phone (option)



M54.00-2006-71

- ▶ Whenever a connection attempt is received by the mobile phone, “Telefon” (Telephone) pop-up window (1) opens and the messages “Eingehender Anruf” (Incoming call) (2) and “Unbekannter Name” (Unknown name) (3) are displayed.



#### Note:

At present, some mobile phone models do not support the transfer of mobile phone numbers. As a result, the name assigned to the destination phone number cannot be displayed. “unbekannter Name” (unknown name) (3) is therefore displayed instead.

- ▶ Using “hang up the telephone” button (5) on the steering wheel, the driver is able to close the pop-up window and thereby reject the call.
- ▶ The driver can answer the call by pressing “pick up the telephone” button (4) on the steering wheel.

## Parking brake and emergency release device



M54.00-2007-71

- ▶ While a call is in progress, “Anruf...” (Call...) (2) and “Unbekannter Name” (Unknown name) (3) are displayed in the “Telefon” (Telephone) pop-up window (1). The driver can end the call by pressing “hang up the telephone” button (4) on the steering wheel.

 **Note:**

Using “OK” button (5) on the steering wheel, the driver is able to close the pop-up window without ending the call. This frees up the display screen and other menus can now be displayed. For as long as the call remains active, the driver can restore the pop-up window by pressing the “pick up the telephone” button on the steering wheel.

 **Note:**

At present, some mobile phone models do not support the transfer of mobile phone numbers. As a result, the name assigned to the destination phone number cannot be displayed. “unbekannter Name” (unknown name) (3) is therefore displayed instead.

**Parking brake and emergency release device**

Parking brake valve (1) combined with the emergency release device for brake spring cylinders

 **Caution:**

The parking brake spring cylinders require a release pressure of 5.8 to 6.4 bar. At low supply pressures, there is a risk that the brake may not be fully released, that the friction pads may make slight contact while the bus is in motion and that the brake may be subjected to unnecessarily high thermal loads. When the parking brake is released, the corresponding icon on the screen must go out. If the compressed-air system for the parking brake is damaged, it is possible to release the parking brake using the emergency release device: The emergency release device is combined with the parking brake valve and is operated in exactly the same way as the normal parking brake. The valve automatically switches over to the air reserve for the emergency release device and the spring cylinders are released.

### Air suspension safety precautions



#### Caution:

Do not apply the parking brake unless the bus is stationary.



#### Danger.

Always apply the parking brake before you leave the driver's area.



#### Danger.

Check the hand lever for full engagement.



#### Danger.

If the parking brake is applied while the bus is in motion, ABS can no longer perform its intended function.



M42.00-0838-71

▷ For notes on safety and operation, refer to the “Operation” section of the Operating Instructions.

### Air suspension safety precautions

The forward section of the chassis and the guidance of the driven axle have been structurally designed in such a way as to ensure that the bus remains manoeuvrable when the suspension air bags have been depressurised.

In this condition, the full weight of the vehicle body is supported by the stop buffers fitted at the forward section of the chassis and at the rear axle. These stop buffers are unladen when the suspension is at normal level and are intended only to prevent the body of the vehicle from dropping onto the axle in the event of extreme suspension compression. The stop buffers are not designed for permanent loading and cannot be used as a replacement for the normal suspension under any circumstances. The bodywork could otherwise suffer damage (cracks, etc.).

 **Danger.**

Although the bus remains manoeuvrable while the suspension is depressurised, it must be driven no faster than walking pace to the nearest lay-by or OMNIplus Service Partner. Whenever work is carried out on the air suspension system, the body must always be supported by jacks and stands positioned at the designated points because the body of the bus could drop relatively quickly in the event of a loss of air.

**Raising/lowering the bus**

- ▶ Preconditions: Ignition starter switch ON, bus stationary, doors closed, operating pressure > 6.5 bar, level control operational.
- ▶ Raising or lowering is initiated in response to a single press of the button with the door closed. It is possible to interrupt or reverse the lowering process by pressing the "Normal level" pushbutton.



 **Danger.**

It is prohibited to lower the bus while persons are present in the immediate vicinity of the bus.

 **Danger.**

Do not exceed the maximum permissible vehicle height when driving with the bus raised above normal level. In Germany, the maximum permissible vehicle height is limited to 4 metres. Regulations may vary from country to country and must be observed accordingly.

 **Danger.**

The bus is not permitted to be driven faster than walking pace whenever it has been raised or lowered out of normal level.

 **Note:**

The suspension air bags are deflated or inflated and the superstructure is lowered or raised by 70 mm respectively.

## Normal level



### Note:

It is possible to raise or lower the bus only at speeds of up to 20 km/h.



### Note:

The bus automatically returns to the normal level if it is driven faster than 30 km/h.



### Note:

Since an increase in ride height increases the approach angle, it is advisable to raise the bus above normal level before driving up zigzag roads, for example.



### Note:

The corresponding symbol appears on the instrument cluster display screen whenever the bus has been raised or lowered.



### Caution:

The vehicle may not be moved with snow chains mounted.

## Normal level

- ▶ Preconditions: Ignition starter switch ON, bus stationary, doors closed, operating pressure > 6.5 bar, level control operational.
- ▶ Press the pushbutton to return the bus to normal level.



### Note:

Bus normal level (driving position).

## Activating/deactivating axle load transfer for trailing axle (3-axle buses only)

### Activating/deactivating axle load transfer for trailing axle (3-axle buses only)



M54.00-1947-71

- ▶ The axle load transfer of the trailing axle is activated by pressing pushbutton (1) in the driver's area.

#### **i** Note:

The axle load transfer (pull-away aid) is primarily used in the winter for pulling away or for reversing in wintry road conditions. Tyre contact pressure at the driven axle is increased because the load on the trailing axle is reduced.

#### **i** Note:

When the function is activated, the supply of compressed air to the suspension air bags on the trailing axle is interrupted. The suspension air bags are then vented of air by an overflow valve.

#### **i** Note:

The pull-away aid cannot be activated unless the ignition starter switch is ON and the bus is travelling at a speed of below 12 mph (20 km/h).

#### **i** Note:

Whenever ASR intervenes, the pull-away aid is activated automatically.

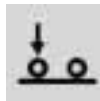

When the pull-away aid is active, the LED lights up in the pushbutton and the "Pull-away aid active" symbol appears on the screen.

- ▶ To deactivate the pull-away aid, press rocker switch (1) again.

#### **i** Note:

The pull-away aid will be cancelled if the air pressure in the suspension air bags of the driven axle exceeds 7 bar while the bus is in motion and the axle load relief function is active. The load on the suspension air bags is restored to normal balance.

#### **i** Note:

Similarly, the pull-away aid is deactivated as soon as the bus exceeds 18 mph (30 km/h).

### Activating/deactivating the bus stop brake

#### Activating/deactivating the bus stop brake

- ▶ Ignition starter switch ON

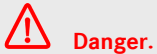

**Danger.**

Do not activate the bus stop brake unless the bus is stationary. The bus stop brake must not be used as a means to brake a coasting bus to a halt. The bus must never be parked with only the bus stop brake applied. Apply the parking brake at bus stops on uphill or downhill gradients steeper than 15%.



**Danger.**

Always apply the parking brake correctly before you leave the driver's area.

- ▶ Press the bus stop brake pushbutton.



The wheels on the driven axle are braked with reduced pressure.



**Note:**

The icon above appears on the instrument cluster display screen.



**Note:**

The "Ready to depart" icon appears on the display screen at the same time.

- ▶ Depress the accelerator pedal.

The "bus stop brake" function is deactivated again and the icons on the display screen go out.



**Note:**

The bus stop brake is also deactivated if you apply the parking brake or switch the ignition starter switch to OFF.



## Important information on the steering system

## Important information on the steering system

The dimensions of the steering system and the mechanical steering transmission ratio were designed such that, in the event of a malfunction in the hydraulic power steering system, the effort required to turn the steering wheel would not exceed a specific value deemed by legislators to be the maximum reasonable force.

For vehicles weighing over 12 t, this maximum operating force is 450 N (400 N for vehicles between 3.5 t and 12 t) applied to the steering wheel rim in the straight-ahead position. This force must be sufficient to achieve a turning circle with a radius of 20 m at a road speed of approximately 10 km/h.

The driver must be aware that, in the event of a sudden failure in the power steering (e.g. due to a pump drive malfunction), the bus will remain steerable but considerably more effort will be required.

Since there is an extremely low probability of this situation occurring - but if it does occur, it often does so completely unexpectedly - the driver could wrongly assume that the steering system has been blocked. However, the bus does remain steerable provided the driver applies the necessary force.

This important information is intended to clarify the scenario described and prevent the driver from possibly misjudging the situation.

**Danger.**

In the event of a power steering failure, the bus becomes very difficult to steer. Have the malfunction rectified immediately by an OMNIplus Service Partner.

## Turning the steering wheel when the bus is stationary

- ▶ Adhere to the instructions.

**Note:**

To prevent damage to the steering column, the following points must be observed when turning the steering wheel with the bus stationary, without hydraulic support (engine switched off) and without a turntable under the front wheels (tyres in direct contact with the ground):

- ▶ Release the steering wheel adjuster and push the steering wheel fully down. Lock the steering wheel adjuster in place. Turn the steering wheel using both hands at an angle of 90° to 180° to one another.

**Caution:**

Never have more than one person turn the steering wheel. Do not pull the steering wheel on one side only.

### Switching on the panorama camera (option)



#### Note:

We ask the workshop in particular to note this.

#### Switching on the panorama camera (option)

- ▶ Switch on the panorama camera using this switch. An image of the area to the front of the bus is displayed on the monitors inside the bus.



M82\_00-0122-71

- ▶ There must be no objects positioned between the windscreen and camera (1).

|  |            |
|--|------------|
| <b>Master safety switch (emergency-off switch) (national variant) .....</b>                    | <b>170</b> |
| <b>Windscreen roller sunblind pushbutton .....</b>   | <b>171</b> |
| <b>Co-driver's roller sunblind pushbutton .....</b>  | <b>171</b> |
| <b>Pushbutton for windscreen heating (option)/driver's window heating+mirror heating .....</b> | <b>171</b> |
| <b>Pushbutton for upper wiper (option)/headlamp cleaning system .....</b>                      | <b>172</b> |
| <b>Inverter (option) .....</b>   | <b>172</b> |
| <b>Kitchenette/attendant call enabling pushbutton (option) .....</b>                           | <b>172</b> |
| <b>Lavatory/multichannel audio system enabling switch (option) .....</b>                       | <b>173</b> |
| <b>Video system/reversing camera washer system switch (option) .....</b>                       | <b>173</b> |
| <b>Active Brake Assist OFF pushbutton (option) .....</b>                                       | <b>173</b> |
| <b>Lane assistant warning system pushbutton (option) .....</b>                                 | <b>174</b> |
| <b>Acceleration skid control (ASR) OFF/Electronic Stability Program (ESP) pushbutton .....</b> | <b>174</b> |
| <b>Switch for deactivating pedal-activated continuous braking .....</b>                        | <b>174</b> |
| <b>Axle load transfer switch (3-axle buses only) .....</b>                                     | <b>175</b> |
| <b>“School bus operation” pushbutton (option) .....</b>  | <b>175</b> |
| <b>Reverse warning signal (option)/air horn ON .....</b>                                       | <b>175</b> |

### Table of contents

|   |     |
|---|-----|
| Emergency switch for alcohol interlock .....                            | 176 |
| Central locking pushbutton for the left-side luggage compartment .....  | 176 |
| Central locking pushbutton for the right-side luggage compartment ..... | 176 |
| Front roof hatch pushbutton - air in/air out .....                      | 177 |
| Rear roof hatch pushbutton - air in/air out .....                       | 177 |
| Driver's power window pushbutton .....                                  | 178 |
| Diesel particulate filter (DPF) regeneration .....                      | 178 |
| Driver's seat microphone switch (option) .....                          | 179 |
| Bus stop brake emergency release switch (option) .....                  | 179 |
| Door I pushbutton .....   | 179 |
| Door II pushbutton .....  | 180 |
| Emergency valve reset pushbutton (option) .....                         | 180 |
| Hazard warning lamps pushbutton .....                                   | 180 |
| Normal level/kneeling pushbutton .....                                  | 181 |
| Pushbutton for raising/lowering the bus .....                           | 181 |
| Hillholder and bus stop brake .....                                     | 181 |

|   |            |
|---|------------|
| <b>Auxiliary batteries pushbutton (option)</b> .....              | <b>182</b> |
| <b>Steering column adjustment switch</b> .....                    | <b>183</b> |
| <b>Driver's area lighting switch</b> .....                        | <b>183</b> |
| <b>Reading lamps switch</b> .....                                 | <b>183</b> |
| <b>Bus stop brake pushbutton (option)</b> .....                   | <b>184</b> |
| <b>Passenger-compartment lighting switch positions I+II</b> ..... | <b>184</b> |
| <b>Night lighting switch</b> .....                                | <b>185</b> |
| <b>ADR pushbutton (option)</b> .....                              | <b>185</b> |

### Master safety switch (emergency-off switch) (national variant)

#### Master safety switch (emergency-off switch) (national variant)

When master safety switch (1) is operated, the engine is switched off if running. The tachograph, instrument cluster (option), interior lighting and roof hatches remain operational. Operate the emergency-off switch by pressing the red knob. Unlock the switch by turning the red knob anti-clockwise.



#### Danger.

Risk of accident. The emergency-off switch should not be operated except in an emergency and only with the bus stationary - never while the bus is in motion. Operation of the emergency-off switch causes the engine to switch off automatically. The power steering would consequently be disabled if the bus were in motion. Additional effort would then be required in order to steer. Furthermore, the power supply to all important electrical consumers (e.g. bus lighting, ABS, electronic transmission shift system, etc.) would be interrupted. The roadworthiness of the bus is at risk.



#### Note:

Additional functions may be available, depending on the national variant.



#### Note:

In Finland, Greece, Spain and Italy, the hazard warning lamps and interior lighting are switched on automatically. The central locking is enabled (ECE-R 36).



#### Note:

In France, the hazard warning lamps are enabled.



#### Note:

In Norway, the hazard warning lamps, interior lighting, auxiliary heating (water heater) and horn are enabled.



#### Note:

In Poland, the hazard warning lamps are switched on automatically.



#### Note:

In Austria, operating the emergency-off switch switches off the engine and interrupts the supply of power to the entire electrical system.



M54\_00-0986-01

## Windscreen roller sunblind pushbutton

## Windscreen roller sunblind pushbutton

The pushbutton is used to raise or lower the roller sunblind. The roller sunblind is active only for as long as the pushbutton is pressed.



## Co-driver's roller sunblind pushbutton

The pushbutton is used to raise or lower the roller sunblind. The roller sunblind is active only for as long as the pushbutton is pressed.



## Pushbutton for windscreen heating (option)/driver's window heating+mirror heating

Press upper section of switch: The windscreen heating is activated and the associated LED in the pushbutton lights up. Press lower section of switch: The driver's window and exterior mirror heating is activated and the associated LED in the pushbutton lights up. To switch off the function selected, press the upper or lower section of the pushbutton again as applicable. The associated LED goes out.

**Note:**

These functions cannot be activated unless the engine is running.



### Pushbutton for upper wiper (option)/headlamp cleaning system

#### Pushbutton for upper wiper (option)/headlamp cleaning system

Upper section of pushbutton pressed: The upper windscreen wiper is switched on. The upper wiper operates at intermittent/continuous speed, depending on the windscreen wiper speed selected at the steering column switch (combination switch). Lower section of pushbutton pressed: The wash function will also be activated whenever the windscreen washer system is operated.



#### Inverter (option)

Upper section of switch pressed: 230 V inverter switched on.



#### Kitchenette/attendant call enabling pushbutton (option)

Press upper section of pushbutton: With the kitchenette enabled, it is possible to use the water supply, the lighting and selected basic functions. Press lower section of pushbutton: The attendant call system is switched on.



▷ For notes on safety and operation, refer to the “On-board kitchenette” section of the Operating Instructions.



## Lavatory/multichannel audio system enabling switch (option)

## Lavatory/multichannel audio system enabling switch (option)

Press upper section of pushbutton: All functions in the lavatory cabin are available when the lavatory cabin has been enabled. Press lower section of pushbutton: The headphone sockets of the audio system are switched on.



▷ For notes on safety and operation, refer to the “Lavatory” section of the Operating Instructions.

## Video system/reversing camera washer system switch (option)

Upper section of switch pressed: Panorama camera active. Lower section of switch pressed: The washer system of the reversing camera is active.



## Active Brake Assist OFF pushbutton (option)

This pushbutton is used to deactivate Active Brake Assist (ABA). The red LED in the pushbutton lights up while ABA is deactivated.



▷ For notes on safety and operation, refer to the “Driving systems” section of the Operating Instructions.

### Lane assistant warning system pushbutton (option)

#### Lane assistant warning system pushbutton (option)

This pushbutton is used to disable the lane assistant warning system function, which is otherwise activated once a speed of 70 km/h is reached.



▷ For notes on safety and operation, refer to the “Driving systems” section of the Operating Instructions.

#### Acceleration skid control (ASR) OFF/Electronic Stability Program (ESP) pushbutton

This pushbutton deactivates the ESP function. The dynamic handling control (FDR) and acceleration skid control (ASR) functions are also disabled. This is indicated by the yellow “ESP off” and “TC off” warning lamp. Pressing the pushbutton again or switching the ignition starter switch to OFF and back to ON reactivates the function.



▷ For notes on safety and operation, refer to the “Operation” section of the Operating Instructions.

#### Switch for deactivating pedal-activated continuous braking

None of the continuous brakes available in the bus (retarder, engine brake, constantly open throttle) will be activated in addition to the service brake when the driver depresses the brake pedal.



#### Note:

This switch is for use mainly in wintry road conditions so that the driver can moderate the braking effect more effectively.



▷ For notes on safety and operation, refer to the “Operation” section of the Operating Instructions.

## Axle load transfer switch (3-axle buses only)

## Axle load transfer switch (3-axle buses only)

Pressing the pushbutton on the instrument panel activates the axle load transfer of the 3rd axle provided the bus is travelling at a speed of below 30 km/h. If the axle load transfer is already active, pressing the pushbutton deactivates the function. If active, the axle load transfer will be deactivated automatically as soon as the bus is travelling faster than 30 km/h. A symbol on the screen and an LED in the pushbutton indicate whether the axle load transfer is active.



▷ For notes on safety and operation, refer to the “Driver's area controls” section of the Operating Instructions.

## “School bus operation” pushbutton (option)

Pressing this pushbutton switches on all the turn signals on the left and right. The school bus warning lights can be deactivated using the school bus warning lights pushbutton or the turn signal switch on the steering column (indicate left or right).



## Reverse warning signal (option)/air horn ON

Upper section of pushbutton pressed: Reverse warning signal OFF. Lower section of pushbutton pressed: Air horn ON.



### Emergency switch for alcohol interlock

#### Emergency switch for alcohol interlock

Pressing this emergency switch disables the alcohol interlock.



#### Note:

This switch has a tamper-evident seal and may be operated only in an emergency or in the event of a malfunction in the alcohol interlock.



#### Central locking pushbutton for the left-side luggage compartment

The luggage compartment flaps can be locked or unlocked electropneumatically using the rocker switch provided the ignition starter switch has been switched to ON. The luggage compartment lighting switches on automatically provided the luggage compartment flap circuit on one side of the bus is unlocked and one of the luggage compartment flaps is open. The LED in the rocker switch provides the driver with a confirmation of the state. LED lit -> luggage compartment flaps unlocked.



#### Central locking pushbutton for the right-side luggage compartment

The luggage compartment flaps can be locked or unlocked electropneumatically using the rocker switch provided the ignition starter switch has been switched to ON. The luggage compartment lighting switches on automatically provided the luggage compartment flap circuit on one side of the bus is unlocked and one of the luggage compartment flaps is open. The LED in the rocker switch provides the driver with a confirmation of the state. LED lit -> luggage compartment flaps unlocked.



## Front roof hatch pushbutton - air in/air out

## Front roof hatch pushbutton - air in/air out

It is possible to move the front and rear roof hatches individually to either the air-in or air-out position using the double rocker switch provided the roof hatches have not been forced closed by air-conditioning or “smog” mode and the wind-screen wipers are not operating at speed 1 or 2. When the roof hatches are open, the indicator lamp in the switch lights up and a corresponding operating symbol (icon) is shown on the display screen. If the upper section of the pushbutton is pressed only briefly, the roof hatch moves to the air-in position. The roof hatch opens fully if the upper section of the pushbutton is pressed for longer than 1 second. If the lower section of the pushbutton is pressed only briefly, the roof hatch moves to the air-out position. The roof hatch closes if the lower section of the pushbutton is pressed for longer than 1 second.



## Rear roof hatch pushbutton - air in/air out

It is possible to move the front and rear roof hatches individually to either the air-in or air-out position using the double rocker switch provided the roof hatches have not been forced closed by air-conditioning or “smog” mode and the wind-screen wipers are not operating at speed 1 or 2. When the roof hatches are open, the indicator lamp in the switch lights up and a corresponding operating symbol (icon) is shown on the display screen. If the upper section of the pushbutton is pressed only briefly, the roof hatch moves to the air-in position. The roof hatch opens fully if the upper section of the pushbutton is pressed for longer than 1 second. If the lower section of the pushbutton is pressed only briefly, the roof hatch moves to the air-out position. The roof hatch closes if the lower section of the pushbutton is pressed for longer than 1 second.

### Driver's power window pushbutton



#### Driver's power window pushbutton

The driver's window can be opened or closed. The power window is active only for as long as the pushbutton is pressed.



**Danger.**

The window's range of movement should be kept clear of all obstructions (e.g. any part of your body) while the pushbutton is being pressed (particularly during closing).



#### Diesel particulate filter (DPF) regeneration

Upper section of pushbutton pressed: Start DPF regeneration. Press lower section of pushbutton: Stop DPF regeneration or inhibit automatic DPF regeneration.



## Driver's seat microphone switch (option)

## Driver's seat microphone switch (option)

This switch activates the microphone at the driver's seat to enable the driver to speak to passengers through the PA system.

**Note:**

Switch off the PA system whenever the microphone is not being used.



## Bus stop brake emergency release switch (option)

This switch has a tamper-evident seal and is intended to be operated only in the event of a malfunction in the bus stop brake or drive-off lock.

**Danger.**

Make absolutely sure that the parking brake is applied before you operate the bus stop brake emergency release switch. The bus could otherwise roll away.



▷ For further notes on safety and operation, refer to the “Practical advice” section.

## Door I pushbutton

The driver's pushbutton opens or closes the front right door. The bus must be stationary for the door to open. The open state is displayed to the driver by an indicator lamp in the driver's pushbutton and a corresponding icon on the instrument cluster display screen.

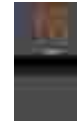

▷ For notes on safety and operation, refer to the “Opening/locking” section of the Operating Instructions.

### Door II pushbutton

#### Door II pushbutton

The driver's pushbutton opens or closes the centre right door. The bus must be stationary for the door to open. The open state is displayed to the driver by an indicator lamp in the driver's pushbutton and a corresponding icon on the instrument cluster display screen.

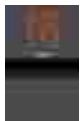

▷ For notes on safety and operation, refer to the “Opening/locking” section of the Operating Instructions.

#### Emergency valve reset pushbutton (option)

If the emergency valve reset pushbutton is pressed while the ignition starter switch is ON, the emergency valve that has been operated will be reset to its initial position.



#### Hazard warning lamps pushbutton

All the turn signals on the left and right are switched on regardless of the position of the ignition starter switch. The turn signal indicator in the hazard warning lamps switch flashes and the green turn signal indicator lamps in the instrument cluster flash.





## Normal level/kneeling pushbutton

## Normal level/kneeling pushbutton

Pressing the upper section of this pushbutton returns the bus to normal level. Pressing the lower section of the pushbutton causes the bus to lower at the front right (kneeling).



▷ For notes on safety and operation, refer to the “Driver's area controls” section.

## Pushbutton for raising/lowering the bus

The bus is raised or lowered when the pushbutton is pressed.



▷ For notes on safety and operation, refer to the “Driver's area controls” section.

## Hillholder and bus stop brake

Upper section of switch pressed: Hillholder active. Lower section of switch pressed: Bus stop brake active. When the bus stop brake pushbutton is pressed, all wheel brakes are applied with reduced pressure. It is prohibited to activate the bus stop brake unless the bus is stationary.



**Danger.**

Do not switch on the hillholder in wintry road conditions. The wheels could lock after coming to a halt on an uphill or downhill gradient and the vehicle could begin to skid uncontrollably. The hillholder is merely an aid designed to help the driver to pull away.

### Auxiliary batteries pushbutton (option)



#### **Danger.**

If the bus stop brake is not used as intended, the vehicle could roll away. This could result in an accident with serious or fatal injuries. Therefore: - Always apply the parking brake before you start/stop the engine or leave the driver's area (refer to the "Operation" section of the Operating Instructions).



#### **Danger.**

Do not under any circumstances use the bus stop brake as a parking brake or hillholder. - Apply the parking brake whenever you come to a stop on a steep uphill or downhill gradient of more than 15 % or pull into a bus stop on a steep uphill or downhill gradient of more than 15 %. - Do not activate the bus stop brake unless the vehicle is stationary.



▷ For notes on safety and operation, refer to the "Driver's area controls" section of the Operating Instructions.

### Auxiliary batteries pushbutton (option)

To ensure reliable starting of the engine after the bus has been parked for long periods with electrical consumers switched on, the supply of power can be switched to the auxiliary batteries for a limited time. Power is supplied from the auxiliary batteries for as long as the pushbutton is pressed in.



## Steering column adjustment switch

## Steering column adjustment switch

With the switch pressed, it is possible to adjust the height and angle of the steering wheel.

**Caution:**

Do not attempt to adjust the steering wheel unless the bus is stationary and the parking brake is applied.



## Driver's area lighting switch

With the ignition starter switch switched ON, the driver's area lighting can be switched on and off.



## Reading lamps switch

With the lower section of the switch pressed, the driver can switch on the reading lamps as additional lighting for the vehicle interior provided the ignition starter switch has been switched to ON and economy mode is not active. All the reading lamps are then switched on. With the upper section of the switch pressed (position 2), the driver can enable the reading lamps for passengers provided the conditions described above have been fulfilled and, in addition, the side lamps have been switched on.



### Bus stop brake pushbutton (option)

#### Bus stop brake pushbutton (option)

When the pushbutton is pressed, all wheel brakes are applied with reduced pressure. It is prohibited to activate the bus stop brake unless the bus is stationary.



#### Danger.

If the bus stop brake is not used as intended, the vehicle could roll away. This could result in an accident with serious or fatal injuries. Therefore: - Always apply the parking brake before you start/stop the engine or leave the driver's area (refer to the "Operation" section of the Operating Instructions).



#### Danger.

Do not under any circumstances use the bus stop brake as a parking brake or hillholder. - Apply the parking brake whenever you come to a stop on a steep uphill or downhill gradient or pull into a bus stop on a steep uphill or downhill gradient. - Do not activate the bus stop brake unless the vehicle is stationary.



▷ For notes on safety and operation, refer to the "Driver's area controls" section of the Operating Instructions.

#### Passenger-compartment lighting switch positions I+II

With the lower section of the switch pressed, all of the interior lighting can be switched on provided the ignition starter switch has been switched to ON and economy mode is not active. If the ignition starter switch is OFF, however, it is the night lighting that will be switched on, even if economy mode is active. With the upper section of the switch pressed and the ignition starter switch ON, the night lighting can be switched on even if economy mode is active.



#### Night lighting switch

Using this switch, it is possible to switch on the LED night lighting provided the side lamps are switched on.



#### ADR pushbutton (option)

This pushbutton is used to switch on the accident data recorder (ADR).





|  |            |
|--|------------|
| <b>Driver's seat safety precautions</b> .....              | <b>188</b> |
| <b>Grammer driver's seat control elements</b> .....        | <b>190</b> |
| <b>ISRI 6860/875 driver's seat controls (option)</b> ..... | <b>192</b> |
| <b>Operation of the jump seat</b> .....                    | <b>194</b> |
| <b>Adjusting a passenger seat</b> .....                    | <b>195</b> |
| <b>Removing a seat squab</b> .....                         | <b>196</b> |
| <b>Fitting a seat squab</b> .....                          | <b>196</b> |
| <b>Using the driver's seat belt</b> .....                  | <b>196</b> |
| <b>Operating the jump-seat seat belt</b> .....             | <b>197</b> |
| <b>Passenger-compartment-seating seat belt</b> .....       | <b>197</b> |
| <b>Passenger seat service set</b> .....                    | <b>198</b> |

## Driver's seat safety precautions

### Driver's seat safety precautions

It is essential that the following instructions be observed:



#### **Danger.**

In the interests of road safety, the driver's seat must not be adjusted when the bus is in motion.



#### **Note:**

The following descriptions provide a brief overview of the control elements. The manufacturer's operating instructions provided must be observed in all cases.



#### **Danger.**

In the event of a frontal collision, the driver's seat shifts backwards approximately 20 centimetres. As this is intended to increase the driver's all-important survival space, no objects are permitted to be stowed behind the driver's seat.





## Driver's seat/passenger seats

### Grammer driver's seat control elements

#### Grammer driver's seat control elements

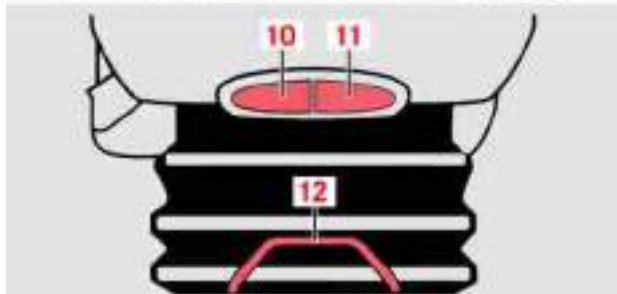
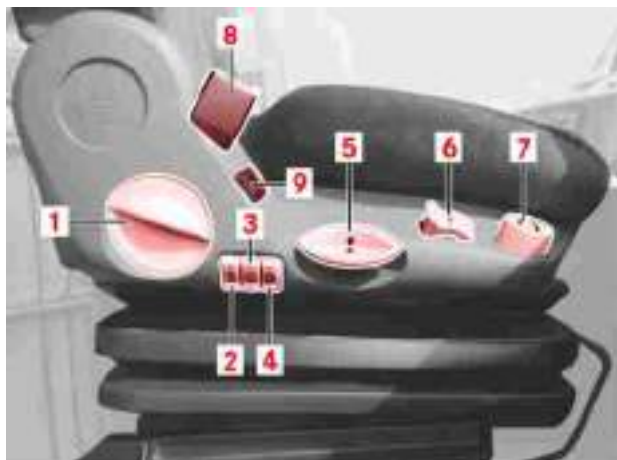

|   |  |    |  |    |   |
|---|--|----|--|----|---|
| 1 | <p>Backrest adjustment</p> <div style="border: 1px solid #ccc; padding: 5px; margin-bottom: 10px;"> <p><b>i</b> <b>Note:</b></p> <p>Relieve load on backrest - pull lever upwards - move into required position - release lever.</p> </div>                            | 5  | <div style="border: 1px solid #ccc; padding: 5px; margin-bottom: 10px;"> <p><b>i</b> <b>Note:</b></p> <p>(+) chamber fills up/(-) chamber empties</p> </div> <p>Height adjustment</p>                                | 11 | <div style="border: 1px solid #ccc; padding: 5px; margin-bottom: 10px;"> <p><b>i</b> <b>Note:</b></p> <p>Relieve the load on the backrest. Pull button upwards. The seat angle can now be adjusted.</p> </div> <p>Seat cushion depth adjustment</p> |
| 2 | <p>Lateral support adjustment</p> <div style="border: 1px solid #ccc; padding: 5px; margin-bottom: 10px;"> <p><b>i</b> <b>Note:</b></p> <p>Individually adjustable lateral support by two compressed-air chambers. (+) chamber fills up/(-) chamber empties</p> </div> | 6  | <div style="border: 1px solid #ccc; padding: 5px; margin-bottom: 10px;"> <p><b>i</b> <b>Note:</b></p> <p>Pull lever up = upwards adjustment/press lever down = downwards adjustment</p> </div> <p>Damper setting</p> | 12 | <div style="border: 1px solid #ccc; padding: 5px; margin-bottom: 10px;"> <p><b>i</b> <b>Note:</b></p> <p>Pull button upwards. The seat cushion can now be adjusted.</p> </div> <p>Driver's seat fore-and-aft adjustment</p>                         |
| 3 | <p>Lumbar support (upper chamber)</p> <div style="border: 1px solid #ccc; padding: 5px; margin-bottom: 10px;"> <p><b>i</b> <b>Note:</b></p> <p>(+) chamber fills up/(-) chamber empties</p> </div>   | 7  | <div style="border: 1px solid #ccc; padding: 5px; margin-bottom: 10px;"> <p><b>i</b> <b>Note:</b></p> <p>The damper setting can be continuously adjusted between soft and hard</p> </div> <p>Rapid lowering</p>      |    | <div style="border: 1px solid #ccc; padding: 5px;"> <p><b>i</b> <b>Note:</b></p> <p>Pull lever upwards. The seat can now be slid in the longitudinal direction.</p> </div>  |
| 4 | <p>Lumbar support (lower chamber)</p>  | 8  | <p>Seat belt buckle</p>  |    |   |
|   |  | 9  | <p>Seat heating/seat climate control (option)</p>  |    |   |
|   |  | 10 | <p>Seat cushion angle adjustment</p>   |    |   |

## Driver's seat/passenger seats

### ISRI 6860/875 driver's seat controls (option)

ISRI 6860/875 driver's seat controls (option)



1 Driver's seat fore-and-aft adjustment



**Note:**

Pull lever upwards. The seat can now be slid in the longitudinal direction.

2 Tilt adjustment



**Note:**

Pull the handle up. Adjust the tilt angle by applying load on or relieving load from the forward section of the seat squab.

3 Seat squab depth adjustment



**Note:**

Pull the lever up and slide the seat squab forwards/backwards. Engage the seat squab again.

4 Heating



**Note:**

Thermostatically controlled seat squab and backrest heating.

5 Lowering



**Note:**

Lower the seat by pressing the rocker switch down. Move the seat to the adjusted height by pressing the rocker switch up.

6 Damper adjustment



**Note:**

Handle up = minimum damping. Handle down = maximum damping.

7 Height adjustment



**Note:**

Pull or press the handle and adjust the seat to the desired height.

8 Lumbar support



**Note:**

Press the buttons to charge or discharge the respective air chambers

9 Swivel release mechanism

10 Backrest adjustment



**Note:**

Pull the handle up and move the backrest to the desired position.

11 Shoulder adjustment



**Note:**

Pull the handle up and move the upper half of the backrest to the desired position.

12 Armrests

## Operation of the jump seat



### Note:

The armrest can be adjusted to any angle using the knurled knob.

## Operation of the jump seat



### Note:

Only accompanying staff should sit on the jump seat.

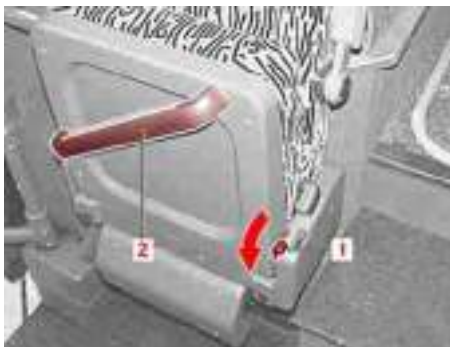

M91\_00-0009-01

- ▶ Folding out the jump seat: move stop lever (1) in the direction of the arrow and fold down the seat cushion using grab handle (2).

The jump seat cannot be stopped in the horizontal position. You must hold down the seat cushion until you are seated.



### Danger.

If you stand up, the seat cushion will automatically return to its original position. Fold the jump seat down again as described above if you wish to sit down again on this seat.

### Adjusting a passenger seat

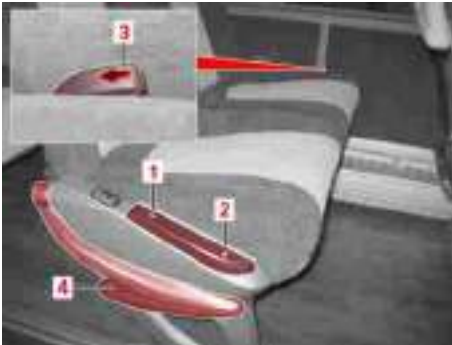

M91.00-0046-71

- ▶ Adjusting the backrest (aisle side):

#### **i** Note:

Press the rear section of rocker (1) and, at the same time, push back on the backrest with your upper body. Release the rocker when the backrest is at the desired position. The backrest locks in place immediately.

#### **i** Note:

There are several backrest positions between the vertical normal position and the tilted limit position. You can choose any of these positions.

- ▶ Adjusting the backrest (window side):

#### **i** Note:

Pull back small black lever (3) between the seat cushion and vehicle wall. At the same time, push back on the backrest with your upper body. Release lever (3) when the backrest is at the desired position.

#### **i** Note:

There are several backrest positions between the vertical normal position and the tilted limit position. You can choose any of these positions.

- ▶ Sideways adjustment of aisle-side seats

#### **i** Note:

Press forward section of rocker (2) and, at the same time, move the seat towards or away from the centre aisle.

- ▶ Folding the armrest up or down

#### **i** Note:

Aisle side: Grasp the front of the raised armrest and lift it slightly. Then carefully fold the armrest down. To fold the armrest up, simply pull it upwards. The armrest engages in its limit position automatically.

#### **i** Note:

Window side: The armrest for the window seat (option) is located between the seats. It simply folds up and down.

### Removing a seat squab

#### Removing a seat squab



M91.00-0047-71

- ▶ To remove the seat squab, grasp the front of the seat squab with both hands and pull upwards. Then pull the squab in the direction of travel and out of the guide and remove it upwards.

#### Fitting a seat squab

- ▶ Lift the seat squab at the front slightly and slide the rear into the guide as far as the stop. Press the front of the seat squab down until you hear it engage.

#### Using the driver's seat belt



##### Note:

The driver's seat that was fitted during production has an integrated belt system. Consequently, the user information and instructions apply only to the factory-fitted belts.



##### Note:

In Germany, the seat belt must remain fastened at all times while the vehicle is in motion (Section 21a of the German road traffic regulations (StVO)). The rules and regulations of the country in which the vehicle is operated must be observed.

- ▶ Fastening the seat belt: pass the seat belt untwisted and tightly across your pelvis and shoulder and insert it into the belt buckle until you hear it engage.



## Operating the jump-seat seat belt

**Danger.**

The seat belt must not pass over your neck, be snagged or rub against sharp edges. It should fit as close to the body as possible. You should therefore avoid wearing bulky clothing. Do not route the seat belt over solid or fragile objects in pockets in your clothing. Frequently retighten the seat belt over your shoulder.

- ▶ Releasing the seat belt: press the red button in the buckle and assist the inertia reel by guiding the seat belt back.

## Operating the jump-seat seat belt

- ▶ Fastening the seat belt: make sure the seat belt is not twisted, position it tightly over your pelvis and lock it so that you can hear it engage in the belt lock.

**Danger.**

This seat should only be occupied by the official person accompanying the bus.

- ▶ Releasing the seat belt: press the red button in the buckle and assist the inertia reel by guiding the seat belt back.

## Passenger-compartment-seating seat belt

- ▶ Fastening the seat belt: make sure the seat belt is not twisted, position it tightly over your pelvis and lock it so that you can hear it engage in the belt buckle.

**Note:**

A seat belt may only be used to restrain one person at any one time.

### Passenger seat service set

#### Passenger seat service set



- 1 Reading lamp soft-touch button
- 2 Attendant call soft-touch button (option)
- 3 Loudspeaker on/off soft-touch button / Stop button (stop request) (option)
- 4 Reading lamp
- 5 Loudspeaker



**Note:**

Loudspeaker volume control at the passenger's seat is also available as an option.

- 6 Attendant call LED (option)
- 7 Ventilation grille regulator



|   |            |
|---|------------|
| <b>Transmission shift system safety precautions .....</b>                                   | <b>202</b> |
| <b>Operating the PSH (pneumatic shift aid) transmission shift system .....</b>              | <b>202</b> |
| <b>Transmission shift system safety precautions .....</b>                                   | <b>203</b> |
| <b>Transmission shift system GO 250-8 (system description) .....</b>                        | <b>204</b> |
| <b>Selector lever of GO 250-8 transmission shift system .....</b>                           | <b>206</b> |
| <b>Operating the GO 250-8 PowerShift transmission shift system .....</b>                    | <b>207</b> |
| <b>Operating the GO 250-8 PowerShift failsafe mode with the steering wheel keypad .....</b> | <b>217</b> |

## Transmission shift system safety precautions

### Transmission shift system safety precautions



#### Danger.

If it is necessary to disembark, even for a short time, with the engine still running, you must make sure that the transmission is in position “N” (neutral), the parking brake has been applied and the vehicle has been secured by chocks. It is permissible to disembark with the engine still running only if no passengers remain in the passenger compartment and the bus has been secured against unauthorised access.

### Operating the PSH (pneumatic shift aid) transmission shift system

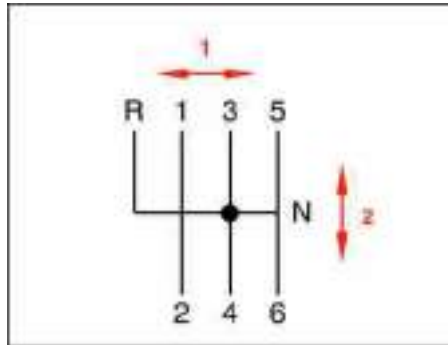

M26\_00-0004-01

#### ► Changing gear



#### Note:

This transmission shift system works purely mechanically. At approximately 90 mm, the shift throws are only half as long as those of conventional shift systems. However, the time that is needed for a gear change in the transmission while synchronisation takes place is almost the same in physical terms. This means that, to engage the next gear, the driver has to move the shift lever handle

much more slowly, i.e. only half as fast as before. Disengagement of a gear is just as fast as normal. The best gearshifts are achieved by moving the gear selector lever with gentle force and “waiting” for the PSH gearshift. Nevertheless, faster gear changes are possible in difficult situations.

#### ► Changing gear in the event of PSH failure



#### Note:

PSH, the pneumatic shift aid, is designed to improve shift comfort. Its pressure is limited to 2.4 bar. If PSH fails, it is still possible to select any of the gears while the bus is in motion, but increased effort will be required. The gearshift duration (shift lever pressed to gear engaged) will be longer because synchronisation will not be as fast.

### Transmission shift system safety precautions



#### Danger.

If it is necessary to disembark, even for a short time, with the engine still running, you must make sure that the transmission is in position “N” (neutral), the parking brake has been applied and the bus has been secured by chocks. It is permissible to disembark with the engine still running only if no passengers remain in the passenger compartment and the bus has been secured against unauthorised access.



#### Danger.

The bus is equipped with a creep function. When the service brake is released with the creep function activated, the bus will creep forwards independently with the engine continuing to run at idling speed. If the engine speed drops below approximately 550 rpm due to increased driving resistance and/or you operate the ser-

vice brake at a low engine speed, the electronics will disengage the clutch automatically. This would interrupt the flow of tractive power and the vehicle could begin to roll back, e.g. on an uphill gradient.



#### Note:

For as long as both the accelerator pedal and the brake pedal remain fully released, the clutch will stay closed and the vehicle will creep at idling speed. This works in the 1st and 2nd gears.



#### Caution:

The least wearing on the clutch is idle creeping. In stop-start traffic, therefore, the brake pedal should be used as sparingly as possible (under consideration of the road and traffic situation) so that the vehicle always creeps at idling speed. To keep the driving speed as low as possible, it is possible to shift manually into 1st gear. If the speed of the bus is kept low by means of the brake pedal, the clutch will start to slip. This would res-

ult in increased clutch wear. If the brake pedal is depressed rather more forcefully (more than 10% brake pedal travel), the clutch will open so far that it no longer slips.



#### Note:

In the event of increased loading on the clutch, an alert (grey) will appear on the display screen. If the load persists, a warning alert (yellow) will appear and the creep function will be deactivated automatically. This is designed to rule out an overloading of the clutch by the creep function.

### Transmission shift system GO 250-8 (system description)

#### Transmission shift system GO 250-8 (system description)

The GO 250-8 transmission is adapted to the engine by a dry clutch. As the clutch is controlled automatically by the transmission system, there is no need for a clutch pedal.

Gears are shifted and the clutch is operated electropneumatically. An electronics unit attached to the transmission controls the valves of the pneumatic actuating cylinders at the gear, gate and clutch.

The driver selects the direction of travel using the selector lever on the steering column and is then able to influence the speed of the vehicle using only the accelerator pedal and brake pedal. Advantage: The driver is relieved of having to change gear and use a clutch.

Using the selector lever on the steering column, the driver can choose between automatic and manual gear selection. Manual gear selection should, however, only be used in special cases, e.g. to brake the bus or when driving over

mountainous terrain. Automatic mode should be used for all normal driving conditions. In automatic mode, 2 shift programs are available: “Basic” and “Dynamic”. The “Basic” shift program is optimised for fuel economy and should generally be the program of choice. In the “Dynamic” shift program, upshifts take place at higher engine speeds. Although this offers faster acceleration, it also results in higher fuel consumption. As the basis for selecting the appropriate gear, the intelligent gear selection function in automatic mode takes into consideration the driver's commands (operation of the accelerator pedal and service brake), the current engine operating state, uphill or downhill gradients and the load on the bus. This achieves the optimum compromise between comfort, fuel economy and wear.

The drive control module coordinates the functions of the drivetrain by informing the engine control module how much engine torque is required and by informing the transmission control module of the

gear to be selected and the clutch position to be adopted.

The mechatronic transmission and engine control units then implement the control commands of the drive control for the engine and transmission.

The screen in the instrument panel shows all necessary system information (e.g. gear, malfunction, etc.) to the driver.

The system has a failsafe mode that can be activated in the event of a fault in the transmission shift system. In this mode, it is possible to drive the bus away from areas of danger or to the nearest workshop. Even if no faults are present, it is possible to activate failsafe mode for training purposes as preparation for this situation.

▷ Refer to “Operation of GO 250-8 failsafe mode” in this section.





### Selector lever of GO 250-8 transmission shift system

Selector lever of GO 250-8 transmission shift system

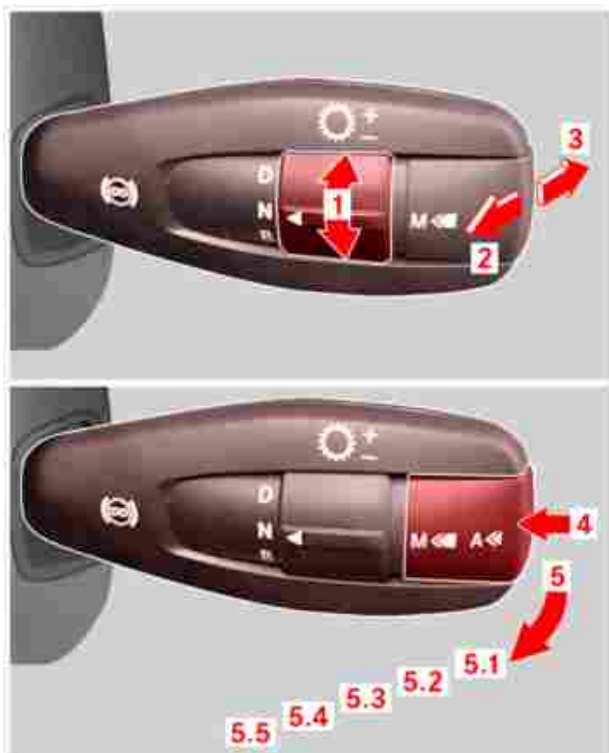

## Operating the GO 250-8 PowerShift transmission shift system

- 1 To select the driving direction
- 2 Manual upshift
- 3 Manual downshift
- 4 To select automatic mode/  
change shift program

**Note:**

To switch from manual mode to automatic mode, press and hold the button.

**Note:**

To change from “Basic” to “Dynamic” in automatic mode, press the button briefly.

- 5 To activate the continuous brakes (retarder and engine brake)

### Operating the GO 250-8 PowerShift transmission shift system

**Danger.**

Never leave the driver's area with the engine running and a gear engaged.

**Danger.**

In the event of a loss of pressure in the auxiliary consumers circuit, the automatic transmission might stop working correctly. This may prevent you from leaving areas of danger in good time. If the “Auxiliary consumers supply pressure” malfunction appears on the display screen and the malfunction display lights up yellow, do not pull away, or, if the bus is already in motion, stop the bus as soon as possible (traffic conditions permitting). Have the compressed-air system checked and repaired at a qualified specialist workshop which has the necessary specialist knowledge and tools to carry out the work required. EvoBus recommends an OMNIplus Service Partner for this purpose. It is essential that work relevant to safety or

work on safety-related systems be carried out at a qualified specialist workshop.

**Danger.**

If the engine speed drops considerably, the PowerShift transmission will automatically disengage the clutch to prevent the engine from stalling. The power flow is interrupted and the bus could roll back, e.g. on uphill gradients, and you could thereby cause an accident. For this reason, never allow the engine speed to drop below 600 rpm in 1st gear.

- ▶ +++ Selecting the operating mode  
+++

**Note:**

With the PowerShift transmission shift system, it is possible to drive in one of two operating modes: Manual mode or automatic mode. In manual mode, you are able to determine the shift point and shift direction yourself. In automatic mode, you simply need to select the driving direction. The PowerShift transmission shift system then changes gear automat-

## Operating the GO 250-8 PowerShift transmission shift system

ically, depending on the engine speed, accelerator pedal position, load on the engine, operating status of the continuous brake, load on the bus and gradient of the road.

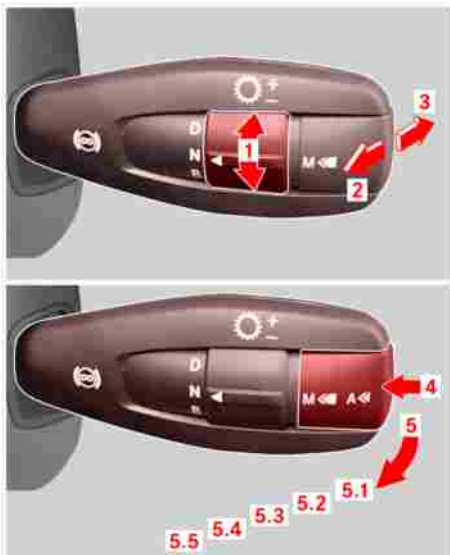

M54.00-1897-72

- ▶ Pressing and holding button (4) switches from manual mode to automatic mode.



M26.00-0181-71

In automatic mode, “Auto” appears below gear indicator (1) with the “Basic” shift program selected. In the “Dynamic” shift program, “Adyn” will be displayed instead.



### Note:

In automatic mode, it is possible to toggle between the “Basic” and “Dynamic” shift programs by briefly pressing button (4).



### Note:

For journeys on arduous terrain, it is advisable to select manual mode in order to avoid undesired upshifting, for example, and therefore interruptions in tractive power.

- ▶ +++ Selecting transmission neutral position +++



### Danger.

If you were to select the transmission neutral position while the bus were in motion, you would lose tractive power or the braking effect of the engine. It may not then be possible to bring the bus to a halt in good time and you could thereby cause an accident. For this reason, you should never select the transmission neutral position while the bus is in motion.

## Operating the GO 250-8 PowerShift transmission shift system



### Note:

Transmission neutral position “N” can be selected directly from any gear.



M54.00-1897-72

- ▶ Shift to neutral position “N”.



M26.00-0182-71

“N” appears in the gear indicator as soon as the transmission neutral position is selected.



### Note:

If the bus is coasting in transmission neutral position “N”, turn driving direction switch (1) forwards (vehicle coasting forwards) or back (vehicle coasting backwards). The PowerShift transmission shift system engages the optimum gear.

- ▶ +++ Selecting reverse gear +++
- ▶ Stop the bus.
- ▶ Apply the service brake or parking brake.



M54.00-1897-72

### Operating the GO 250-8 PowerShift transmission shift system

- ▶ Turn driving direction switch (1) back to "R".

"R" appears in the gear indicator as soon as reverse gear is selected.



M26\_00-0023-01

- ▶ Depress the accelerator pedal slowly and simultaneously release the parking brake.



**Danger.**

The bus may roll away if you do not depress accelerator pedal (5).



**Danger.**

There is no engine braking effect if the bus starts to move without a gear having been selected. Do not allow the bus to roll against the direction of travel of the gear that is currently engaged.

The bus starts to move (clutch closes automatically)

- ▶ Changing the direction of travel



**Danger.**

The direction of travel cannot be changed unless the bus is stationary, otherwise the transmission will automatically shift into neutral. Only the screen display provides a reliable indication of which direction of travel is selected inside the transmission.

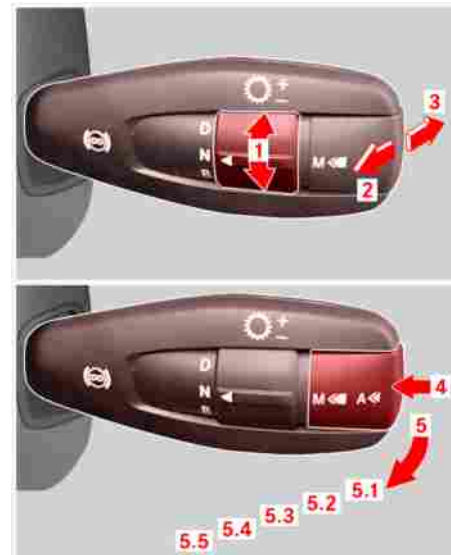

M54.00-1897-72

- ▶ +++ Pulling away +++

## Operating the GO 250-8 PowerShift transmission shift system

- ▶ Turn driving direction switch (1) forwards to “D”.

### **i** Note:

If the driving direction switch is turned quickly from “R” to “D”, the transmission will shift into 1st gear.

The PowerShift transmission shift system selects 2nd gear (starting gear).

### **i** Note:

If the transmission detects an uphill gradient, 1st gear is selected as the starting gear automatically.



M26\_00-0023-01

- ▶ Depress the accelerator pedal slowly and simultaneously release the parking brake.

### **!** Danger.

The bus may roll away if you do not depress accelerator pedal (5).

### **!** Danger.

There is no engine braking effect if the bus starts to move without a gear having been selected. Do not allow the bus to roll against the direction of travel of the gear that is currently engaged.

The bus starts to move (clutch closes automatically)

### **i** Note:

Change the starting gear if 1st gear selected by the PowerShift transmission shift system appears to be an unsuitable gear in which to pull away.

- ▶ +++ Changing the starting gear +++

### **i** Note:

2nd gear is the highest gear that can be selected as the starting gear.

### Operating the GO 250-8 PowerShift transmission shift system

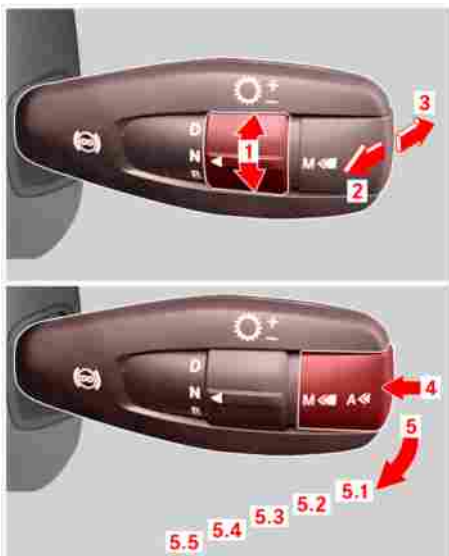

M54.00-1897-72

- ▶ To shift up a gear from the gear selected, pull the selector lever up (2) until resistance can be felt.
- ▶ To shift down a gear, press the selector lever down (3) until resistance can be felt.



M26\_00-0023-01

- ▶ +++ Hill starts +++



A gear must be engaged before you attempt to pull away on an uphill gradient. Then depress accelerator pedal (5). Do not release parking brake (4) until you can feel the torque in the drive train. There would otherwise be a risk of the bus rolling backwards.

- ▶ +++ Accelerating +++



Whenever the maximum engine speed for the current driving situation is reached in the gear selected, the PowerShift transmission shift system shifts up to the next optimum gear (in automatic drive mode).



In automatic mode, you can use the accelerator pedal position to actively influence the shift point. Little throttle = early upshift/more throttle = late upshift.

- ▶ +++ Kickdown (automatic drive mode) +++



Kickdown is used to achieve maximum bus acceleration.



## Operating the GO 250-8 PowerShift transmission shift system

- ▶ Depress the accelerator pedal beyond the pressure point as far as the stop.

**i** **Note:**

The PowerShift transmission shift system will shift down into a lower gear if necessary.

- ▶ Ease off the accelerator pedal once the desired speed has been reached.

**i** **Note:**

The PowerShift transmission shift system shifts back up.

- ▶ +++ Decelerating +++
- ▶ Release the accelerator pedal.

- ▶ Slowly depress the brake pedal and/or activate the continuous brake.

**i** **Note:**

The PowerShift transmission shift system will shift down into a lower gear if necessary (in automatic drive mode).

- ▶ +++Gearshifts in automatic drive mode+++

**i** **Note:**

All upshifts and downshifts are carried out automatically. These take place in response to the driving situation, engine load, accelerator pedal position, road speed and engine speed.

**!** **Caution:**

On steep downhill gradients, the PowerShift transmission shift system does not shift up if the accelerator pedal is not depressed. A warning tone sounds as soon as the engine limit speed is reached. The driver must either brake,

shift up manually or quickly depress the accelerator pedal at least once. There is a risk of consequential engine damage if the driver fails to react in time.



M26.00-0181-71

Screen display in automatic drive mode (gear indicator 1-8 with "AUTO").

- ▶ +++ Gearshifts in manual mode +++

### Operating the GO 250-8 PowerShift transmission shift system



#### Note:

In either operating mode (manual/automatic), it is possible to intervene manually to override the gear selected by the PowerShift transmission shift system.



#### Note:

If the selector lever is pressed and held up (2) or down (3) in manual mode, the transmission will shift into the ideal gear.

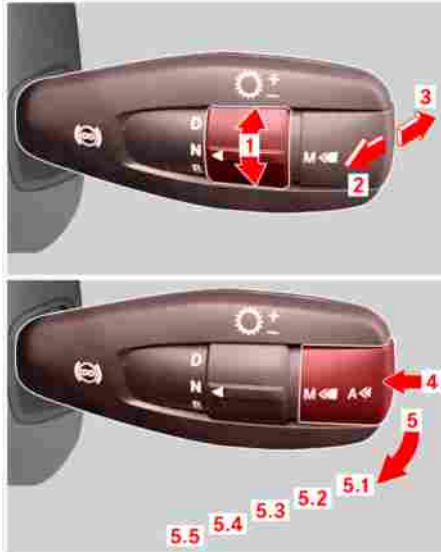

M54.00-1897-72

- ▶ To shift up, pull the selector lever up (2) until resistance can be felt.

The PowerShift transmission shift system shifts up a gear.

- ▶ Pull the selector lever up (2) until resistance can be felt and repeat in quick succession.

The PowerShift transmission shift system shifts up 2 gears.

- ▶ To shift down, press the selector lever down (3) until resistance can be felt.

The PowerShift transmission shift system shifts down a gear.

## Operating the GO 250-8 PowerShift transmission shift system

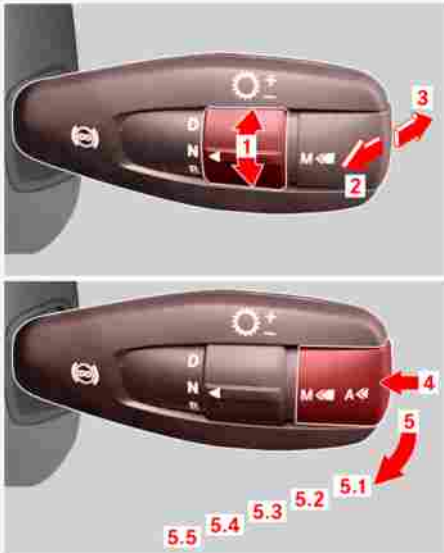

M54.00-1897-72

- ▶ Press the selector lever down (3) until resistance can be felt and repeat in quick succession.

The PowerShift transmission shift system shifts down 2 gears.

### **i** Note:

If the target gear is too low, the PowerShift transmission shift system shifts down only to a permissible gear that would not cause the engine to overrev.

- ▶ Engine braking effect during a gearshift

### **i** Note:

The braking effect of the engine is temporarily interrupted for the duration of a gearshift (drive train disconnected by the transmission system). Once the shift has been completed, the engine braking effect is automatically restored.

### **i** Note:

In automatic drive mode, operation of the continuous brake causes the system to shift down so that maximum engine braking effect is achieved. The extent of the downshift depends on the lever position, actual gear, gradient and retarder temperature.

### **!** Danger.

The engine braking effect is interrupted for the duration of the gearshift. The bus may accelerate if you are driving downhill at this time.

- ▶ +++ Stopping +++

### **!** Danger.

With creep mode activated, the bus will continue to creep forwards with the engine running at idling speed. Whenever creep mode reaches its torque limit, the clutch will open. If this malfunction alert is displayed on the display screen, visit an OMNIplus Service Partner at the earliest opportunity. With creep mode deactivated, the PowerShift transmission shift system automatically disengages the clutch whenever the engine speed drops below 600 rpm in 1st gear. Tractive power would be lost and the bus could roll away if the engine is still running and a gear is still selected (e.g. on uphill gradients). You could thereby cause an accident. Whenever you stop the bus, always secure the bus against rolling away.

## Operating the GO 250-8 PowerShift transmission shift system

using the service brake or the parking brake.

- ▶ Apply the brakes.
- ▶ Shift down if necessary.

The PowerShift transmission shift system disengages the clutch shortly before engine idling speed has been reached.

### Note:

The PowerShift transmission shift system engages the starting gear when the bus comes to a halt.

### Caution:

Do not leave the driver's area with a gear engaged and the parking brake applied. This state is not permitted and over time results in damage to the transmission. Always select the transmission neutral position first.

- ▶ +++ Parking the bus +++

### Danger.

It is not possible to park the bus with a gear engaged. The PowerShift transmission shift system always selects transmission neutral position “N” after the ignition has been switched off. If you do not secure the stationary bus using the parking brake, the bus could roll away and you could cause an accident. For this reason, always secure the bus using the parking brake.

### Note:

A warning tone will sound if the bus has been stationary for 4 minutes with the engine running and a gear selected. “N” flashes on the display screen. After a further minute, the transmission will shift into neutral if neither the selector lever nor accelerator pedal is operated in the meantime.

- ▶ Stop the bus.
- ▶ Apply the parking brake.

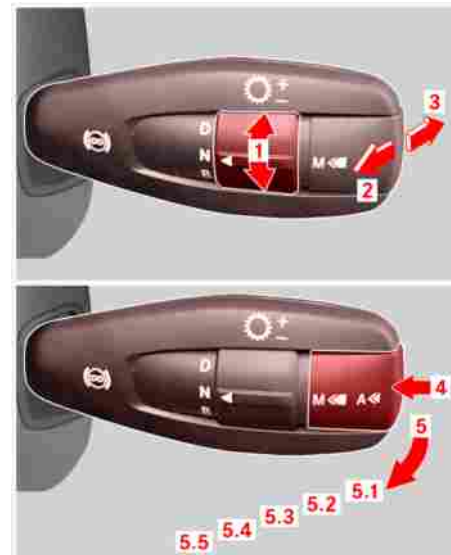

M54.00-1897-72

- ▶ Move the driving direction switch (1) to “N”.

## Operating the GO 250-8 PowerShift failsafe mode with the steering wheel keypad



M26.00-0182-71

“N” appears in gear indicator (1) as soon as the transmission neutral position is selected.

- ▶ Switch off the engine.

### Operating the GO 250-8 PowerShift failsafe mode with the steering wheel keypad



**Danger.**

Never leave the driver's area with the engine running and a gear engaged.



**Danger.**

In failsafe mode, the bus may behave unexpectedly. For this reason, the driver must be particularly alert at all times.



**Note:**

Under specific circumstances, the engine could stall, particularly if the bus is brought to a halt under heavy braking.



**Note:**

A malfunction in the system is indicated on the instrument cluster display screen in conjunction with a red or yellow warning level malfunction display.



**Note:**

In the “Assistenz” (Assistance) menu, it is possible to activate failsafe mode for training purposes even if there is no transmission fault present.



**Note:**

If there is a malfunction in the automated transmission shift system, it may be possible to continue driving in failsafe mode. In failsafe mode, it is not possible to change gear while the bus is in motion.

### Operating the GO 250-8 PowerShift failsafe mode with the steering wheel keypad



#### Note:

Failsafe mode remains active until the ignition is switched off or the driver quits failsafe mode manually.



#### Note:

On selection of the starting gear, the gear indicator will begin to flash. The gear to be engaged when pulling away will be displayed.

- ▶ A malfunction in the system is indicated by an icon appearing in the centre of the display screen in conjunction with a red or yellow warning level malfunction display.



#### Danger.

The bus must be stopped immediately (traffic conditions permitting) if a red warning level malfunction is displayed.

- ▶ Bring the bus to a halt and apply the parking brake.
- ▶ Press “OK” button (1) on the steering wheel.



M68.00-0484-71

The “Ersatzfahrbetrieb” (Failsafe mode) pop-up window opens.



M68.00-0485-71

- ▶ If the parking brake is applied, confirm with “Ja” (Yes) (2).

The display now shows the gear selection menu.

## Operating the GO 250-8 PowerShift failsafe mode with the steering wheel keypad



M68.00-0486-71

- ▶ Pressing the arrow buttons on the steering wheel moves the cursor up or down the list and the selected gearshift takes place when the right arrow button is pressed.

**i** Note:

In the list, the current gear (N) appears in blue and the selectable gears (D1, D2, R and towing) in white.

**i** Note:

Gearshifts in failsafe mode are carried out only while the engine is running.

**i** Note:

If an upshift or downshift is not possible, the corresponding arrow button symbol will appear greyed out.

**i** Note:

If the accelerator pedal is not depressed within the next 10 seconds, it will be necessary to select the gear again.

**i** Note:

A gearshift cannot take place while the bus is in motion. This means that the driver has to choose a forward gear (D1 = slow forward gear or D2 = fast forward gear) or reverse gear while the bus is stationary.

**i** Note:

D2 should be selected only if the bus is on a downhill gradient. An unsuitable gear selection may cause the engine to stall.

**i** Note:

To tow the bus in failsafe mode, it is also necessary to select “Abschleppen” (Towing) mode.

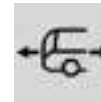

When the gear has been selected, this icon appears on the display screen. It is now possible to pull away by depressing the accelerator pedal within the next 10 seconds.





|   |            |
|---|------------|
| <b>Driving systems (overview)</b> .....   | <b>224</b> |
| <b>Automatic speed limiter, general</b> .....   | <b>225</b> |
| <b>Automatic speed limiter</b> .....  | <b>225</b> |
| <b>Variable speed limiter (Temposet)</b> .....  | <b>226</b> |
| <b>Overview of variable speed limiter (Temposet) controls</b> .....                       | <b>228</b> |
| <b>Activating the variable speed limiter (Temposet)</b> .....                             | <b>229</b> |
| <b>Combined drive/brake cruise control</b> .....  | <b>232</b> |
| <b>Overview of cruise control controls</b> .....  | <b>234</b> |
| <b>Activating drive/brake cruise control</b> .....  | <b>235</b> |
| <b>Setting the speed tolerance in overrun mode</b> .....                                  | <b>238</b> |
| <b>Distance cruise control (option)</b> .....   | <b>239</b> |
| <b>Distance sensor for distance cruise control (ART)</b> .....                            | <b>241</b> |
| <b>Overview of distance cruise control (ART) controls</b> .....                           | <b>242</b> |
| <b>Function description: distance cruise control (ART)</b> .....                          | <b>243</b> |
| <b>Activating distance cruise control (ART) (option) while the bus is in motion</b> ..... | <b>245</b> |

### Table of contents

|   |            |
|---|------------|
| <b>Activating distance cruise control (ART) while the bus is stationary (only with stop-and-go assist (option))</b> ..... | <b>248</b> |
| <b>Setting the specified distance</b> .....   | <b>250</b> |
| <b>Vehicle ahead detected</b> .....   | <b>251</b> |
| <b>How to respond to a distance warning</b> .....   | <b>252</b> |
| <b>Operating displays: distance cruise control</b> .....  | <b>253</b> |
| <b>Active Brake Assist (ABA) (system description)</b> .....   | <b>254</b> |
| <b>Activation/deactivation of Active Brake Assist (automatic)</b> .....   | <b>255</b> |
| <b>Deactivating Active Brake Assist (ABA) (manually)</b> .....  | <b>256</b> |
| <b>Sequence of events when emergency braking initiated by Active Brake Assist (ABA)</b> .....                             | <b>258</b> |
| <b>Function description: warning levels and emergency braking</b> .....   | <b>259</b> |
| <b>Operating/malfunction displays: Active Brake Assist (ABA)</b> .....  | <b>263</b> |
| <b>Special driving situations with distance cruise control/Active Brake Assist</b> .....                                  | <b>266</b> |
| <b>Important information on the lane assistant warning system (option)</b> .....  | <b>270</b> |
| <b>Warning display if lane marking crossed</b> .....  | <b>272</b> |

|   |            |
|---|------------|
| <b>Deactivating the lane assistant warning system .....</b> | <b>272</b> |
| <b>Attention Assist - system description .....</b>          | <b>273</b> |
| <b>Attention Assist - function description .....</b>        | <b>273</b> |

### Driving systems (overview)

#### Driving systems (overview)

The bus may be equipped with the following driving systems:

- Automatic speed limiter
- Variable speed limiter (TempoSet)
- Cruise control (combined drive/brake cruise control)
- Distance cruise control (ART) (option)
- Active Brake Assist (ABA) (option)
- Lane assistant warning system (option)
- Attention Assist (option)



#### Danger.

The driving systems listed are merely aids to assist the driver, e.g. to drive at a preselected road speed. It is always the driver's responsibility to ensure that the actual driving speed and the distance from the vehicle in front are safe and appropriate.



#### Caution:

In the case of buses with manual transmission, the driver has to change gear manually in order to regulate engine speed when the bus is being accelerated or decelerated by drive/brake cruise control or distance cruise control (ART).



M46.00-0200-71

It is possible to switch between the variable speed limiter (TempoSet) and drive/brake cruise control or distance cruise control (ART) (option) driving systems at any time while the bus is in mo-

tion. The symbol for the selected driving system is shown on the display screen.



#### Note:

Press button (3) or (5) respectively on the right-hand side of the steering wheel to switch between the variable speed limiter (TempoSet) and combined drive/brake cruise control or distance cruise control (ART).

## Automatic speed limiter, general

### Automatic speed limiter, general

Since 01.01.2005, all our buses in the EU have been limited to a legally specified maximum speed of 100 km/h.

On steep downhill gradients, this speed may be exceeded for various reasons if the driver does not actively brake the bus.

In these cases, the speed limiter would stabilise the speed of the bus automatically using the continuous brake (retarder).



#### Note:

The maximum limit speed corresponds to the value set in the speed limiter and not to the speed controls in force in other countries (i.e. a fixed value that cannot be changed, e.g. during long-distance travel from one country to another).

### Automatic speed limiter

#### Functions:

- Speed limiter active
- Speed limiter warning message

#### Speed limiter active



M54\_00-1967-71

The automatic speed limiter constantly monitors the maximum speed for the vehicle. If 60 mph (100 km/h) is reached in overrun mode, the engine torque is reduced first. If a speed of 62 mph (104 km/h) is reached despite this measure, the retarder is activated and

this symbol (1) appears on the display screen.

### Speed limiter warning message



M54\_00-1968-71

This warning message appears on the instrument cluster display screen together with a yellow warning level malfunction if a speed of 65 mph (107 km/h) is reached despite use of the retarder or if retarder braking performance is reduced (due to high coolant temperatures). A warning tone also sounds.

### Variable speed limiter (Temposet)



#### **Danger.**

To avoid the risk of endangering passengers and other road users, it will be necessary to brake the bus using the service brake.



#### **Note:**

The menu that was displayed at the time of the warning returns to the display screen as soon as the speed of the bus drops back below the defined maximum speed.

### Variable speed limiter (Temposet)

Using the speed limiter, it is possible to set any speed above 15 km/h as a limit speed. It is possible to accelerate the bus up to the speed set using the accelerator pedal.



#### **Danger.**

The speed limiter limits the set speed automatically. The speed limiter is unable to interpret road and traffic conditions itself.



#### **Note:**

The retarder is automatically activated if the set limit speed is exceeded by more than 4 km/h in overrun mode.



#### **Danger.**

The speed limiter is only an aid designed to assist driving. You are responsible at all times for the speed of the bus and for maintaining an adequate distance to the vehicle in front. Do not use the speed limiter unless traffic conditions permit a constant speed to be maintained.



### Overview of variable speed limiter (TempoSet) controls

Overview of variable speed limiter  
(TempoSet) controls





## Activating the variable speed limiter (TempoSet)

- LIM** To select the variable speed limiter (TempoSet)
- +**  
**SET** To activate and set current speed as limit speed/to increase set limit speed
- **RES** To activate and resume stored limit speed/to reduce set limit speed
-  To select combined drive/brake cruise control or distance cruise control (option)
- OFF** To deactivate the variable speed limiter (TempoSet)

### Activating the variable speed limiter (TempoSet)

**i** **Note:**

It is possible to exceed the stored limit speed, e.g. when overtaking. To do this, depress the accelerator pedal briefly beyond the full-throttle position as far as the stop. As soon as the overtaking manoeuvre is over, release the accelerator pedal briefly and depress it again. This will reactivate the set limit speed.

**i** **Note:**

If the bus is travelling faster than the stored limit speed at this time, the bus will be decelerated automatically by the retarder.



M46.00-0200-71

- ▶ Press “LIM” button (3).

**i** **Note:**

The variable speed limiter (TempoSet) is now selected.

**LIM**

On the display screen, the corresponding symbol is shown in grey.

### Activating the variable speed limiter (TempoSet)

- ▶ Use the accelerator pedal to accelerate the bus up to the desired speed.



M46.00-0200-71

- ▶ Press button (6).



#### Note:

The speed limiter is active and the current speed is set as the limit speed.



#### Note:

Using button (8), it is possible to recall a previously stored limit speed.

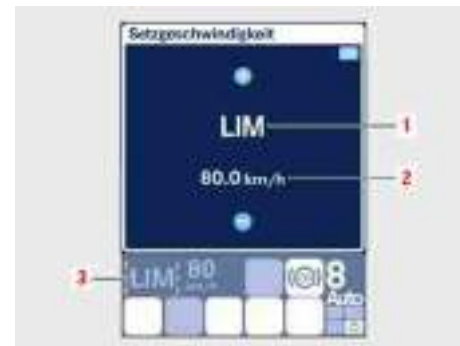

M54\_00-1970-71

A pop-up window containing speed limiter symbol (1) and the set speed (2) appears on the display screen.

- ▶ Press button (6) or (8) briefly.



#### Note:

The limit speed is increased or reduced in increments of 1 km/h respectively.

## Activating the variable speed limiter (TempoSet)

- ▶ Press and hold button (6) or (8) until the desired limit speed is displayed on the display screen.

**i** **Note:**

The limit speed is increased or reduced in increments of 5 km/h respectively.

- ▶ Release button (6) or (8).

**i** **Note:**

The selected limit speed is stored.



M54\_00-1976-71

- ▶ In buses with distance cruise control (option), the “Fahrerassistenz” (Driver assistance) main menu also displays the current distance (4) to the vehicle in front and its speed (5) provided the vehicle is in range of the sensor.

**i** **Note:**

The actual distance to a vehicle in front and its speed are displayed even if the variable speed limiter (TempoSet) is not active.



M46.00-0200-71

- ▶ Press “OFF” button (1).

The variable speed limiter (TempoSet) is deactivated. The driving system's operating display symbol and the previously set limit speed in the lower permanent display field of the display screen appear in grey again. However, the previously set limit speed remains stored and can be recalled by use of button (8).

### Combined drive/brake cruise control

#### Combined drive/brake cruise control

Combined drive/brake cruise control is able to control both the engine and the retarder. The system maintains a stored cruising speed provided there is sufficient engine power output or retarder braking torque available (with a tolerance of +4 km/h on downhill gradients). On level surfaces and on uphill gradients, the speed is regulated by the engine (drive cruise control). On downhill gradients, the speed is regulated by the retarder (brake cruise control). The speed is maintained constant only for as long as the braking performance of the retarder remains sufficient for this to be possible. Whenever necessary, shift down and reduce speed manually.



#### Danger.

To maintain the stored speed, combined drive/brake cruise control automatically operates either the engine control in order to accelerate the bus (drive cruise control) or the engine brake and retarder to decelerate the bus (brake cruise control). Combined drive/brake cruise control is unable to interpret road and traffic conditions itself. For this reason, do not activate combined drive/brake cruise control on slippery road surfaces, in fog or in difficult road and traffic conditions. You could fail to recognise dangers in good time, and endanger yourself and others. When driving on a slippery road surface, the wheels could lock and the bus could skid.



#### Danger.

The cruise control function is only an aid designed to assist driving. The driver is responsible at all times for the speed of the bus and for maintaining an adequate distance to the vehicle in front. Do not use cruise control unless traffic

conditions permit a constant speed to be maintained. On steep uphill or downhill gradients, it may not be possible for a constant speed to be maintained. Take your foot off the accelerator pedal when cruise control is active.



#### Note:

The retarder may be activated for additional braking force. The cruise control system will remain active. The service brake may also be applied while the bus is being braked by the retarder. The cruise control system will remain active. If cruise control is braking the bus using the retarder, the retarder will not be deactivated if the service brake is then applied. As soon as the retarder is deactivated, the bus will accelerate to the previously stored speed.



### Overview of cruise control controls

#### Overview of cruise control controls



## Activating drive/brake cruise control



To select combined drive/brake cruise control or distance cruise control (option)



To activate and set current speed/to increase set speed



To activate and resume stored speed/to reduce set speed



To select the variable speed limiter (Temposet)



To deactivate combined drive/brake cruise control or distance cruise control (option)

### Activating drive/brake cruise control

#### Note:

Precondition: Bus travelling faster than 15 km/h. The clutch and service brake pedals must be fully released and the continuous brakes must not be active.

#### Note:

The speed is maintained constant only for as long as the braking performance of the retarder remains sufficient for this to be possible. Whenever necessary, shift down and reduce speed manually.

#### Note:

It is possible to exceed the stored speed, e.g. when overtaking. To do this, depress the accelerator pedal. When the overtaking manoeuvre is over, release the accelerator pedal again. Cruise control will regulate the speed of the bus to the stored cruising speed.



**Danger.**

If the bus is being braked by the continuous brakes (either by cruise control or by the driver using the retarder lever) while cruise control is active, depressing the service brake pedal will not cause cruise control to switch off, i.e. when the brake pedal is released, the bus will accelerate to the selected cruising speed again.



This symbol indicates that a continuous brake is active

### Activating drive/brake cruise control



M46.00-0200-71

- ▶ Press button (5).

**i** **Note:**

Drive/brake cruise control or distance cruise control (option) is now selected.



On the display screen, the corresponding symbol is shown in grey.

**i** **Note:**

Press button (5) again if necessary until the corresponding symbol for drive/brake cruise control appears on the display screen.

- ▶ Drive at the desired speed and press button (6).

**i** **Note:**

Drive/brake cruise control is now active and the current speed is maintained even if the accelerator pedal is released.

**i** **Note:**

It is possible to resume a previously stored speed by pressing button (8).



M54\_00-1971-71

The pop-up window displays “Cruise control” icon (1) and set cruising speed (2). In addition, symbol (3) for the driving system is displayed in white as an operating display in the lower permanent display field.

**i** **Note:**

Repeated and brief pressing of button (6) (< 0.5 seconds) = set speed increased in increments of 0.5 km/h.



## Activating drive/brake cruise control



### Note:

Repeated and brief pressing of button (8) (< 0.5 seconds) = set speed reduced in increments of 0.5 km/h.



### Note:

Pressing and holding button (6) for longer than 0.5 seconds accelerates the bus. Increases the set speed in increments of 5 km/h. When the combination switch is released, the preselected speed is set as the new value.



### Note:

Pressing and holding button (8) for longer than 0.5 seconds decelerates the bus. Reduces the set speed in increments of 5 km/h. When the combination switch is released, the preselected speed is set as the new value

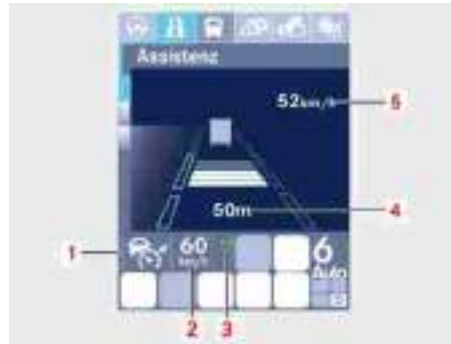

M54\_00-1976-71

- ▶ In buses with distance cruise control (option), the “Fahrerassistenz” (Driver assistance) main menu also displays the current distance (4) to the vehicle in front and its speed (5) provided the vehicle is in range of the sensor.



### Note:

The actual distance to a vehicle in front is displayed even if the cruise control driving system is not active.



M46.00-0200-71

- ▶ Press “OFF” button (1).

Combined drive/brake cruise control is deactivated. The driving system's operating display symbol in the lower permanent display field of the display screen appears in grey again. However, the previously set speed remains stored, also appears in grey and can be resumed by use of button (8). Cruise control will also be deactivated:

### Setting the speed tolerance in overrun mode



#### Note:

- if the bus is braked by means of the service brake and cruise control is currently in operation. The speed set remains stored.



#### Note:

- if the speed of the bus drops below 15 km/h, in which case a short warning signal will sound. The speed set remains stored.



#### Note:

- if the clutch is operated for longer than 5 seconds, e.g. during a gearshift. A short warning signal will sound.



#### Note:

- if the transmission is shifted to the neutral position for longer than 5 seconds. A short warning signal will sound.

### Setting the speed tolerance in overrun mode



#### Note:

The speed tolerance is the maximum allowable difference between actual speed and cruising speed before drive/brake cruise control attempts to decelerate to the set cruising speed on a downhill gradient by activating the retarder. The speed tolerance has an adjustment range of 2 to 15 km/h. It enables better use of momentum at the bottom of the hill in order to save fuel.



M46.00-0200-71

- ▶ Press button (7) repeatedly until the “EcoDrive” input window appears on the display screen.

## Distance cruise control (option)



M54\_00-1987-71

The value currently set for the speed tolerance (2) before which brake cruise control will intervene is displayed.

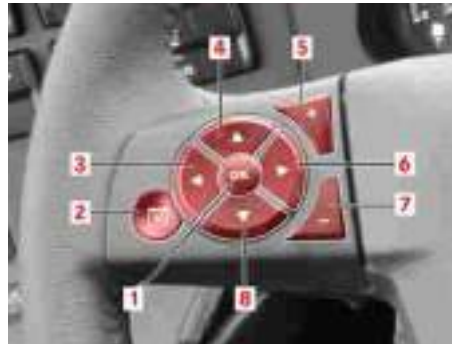

M46.00-0199-71

- ▶ Using arrow button (3) or (6), set the desired speed tolerance in increments of 1 km/h.
- ▶ Press “OK” button (1).  
The setting is stored.

**i** **Note:**

The setting is also stored automatically after 3 seconds.

### Distance cruise control (option)

Distance cruise control (ART) is a convenience system that supplements the functions of conventional cruise control (drive/brake cruise control) with a distance control function. When there is no vehicle in front, distance cruise control operates in the same way as conventional cruise control. If a slower vehicle in front is detected by the distance sensor, the speed of the bus is automatically reduced and the bus maintains the specified distance from the vehicle in front. The cruising speed stored remains unchanged. As soon as the traffic situation permits, e.g. if the vehicle ahead changes lanes, the bus will accelerate up to the cruising speed stored in the cruise control memory.

### Distance cruise control (option)



#### **Danger.**

Distance cruise control (ART) is merely an aid to assist the driver. The driver is responsible at all times for the speed of the bus and for maintaining an adequate distance to the vehicle in front.



#### **Danger.**

Distance cruise control (ART) uses the retarder and, if necessary, the service brake to brake the bus. It is not capable of adjusting the distance to the vehicle in front automatically in response to changing road and visibility conditions. For this reason, do not activate distance cruise control (ART) on slippery road surfaces, in fog or in difficult road and traffic conditions. You could fail to recognise dangers in good time, and endanger yourself and others. When driving on a slippery road surface, the wheels could lock and the bus could skid.



#### **Danger.**

Distance cruise control works only in response to vehicles travelling in front. It does not respond to stationary obstacles on the road, e.g. broken-down vehicles or traffic congestion. If a stationary obstacle is encountered, the bus will not be braked automatically. Only a distance warning may be displayed.



#### **Danger.**

Distance cruise control (ART) is designed for use on motorways or expressways. It is not intended for use on country roads or in built-up areas.



#### **Note:**

It is advisable to deactivate distance cruise control before leaving the motorway or expressway. With no vehicle in front, the bus would accelerate up to the stored cruising speed.



#### **Danger.**

Distance cruise control must be deactivated if the bus is not travelling at normal ride height (e.g. in the event of a fault in the air suspension) because reliable system operation would otherwise no longer be guaranteed. Distance cruise control should also be deactivated on construction sites or other ground of similarly poor quality.

### Distance sensor for distance cruise control (ART)

Distance cruise control may not function correctly in unfavourable weather conditions (e.g. snow, slush) or if the sensor cover has been heavily soiled.

**Note:**

Clean the cover in the front bumper occasionally.

**Note:**

Check the cover for damage. Replace damaged covers with new ones.

**Note:**

Painting or repair work around the distance sensor is not permissible.

### Overview of distance cruise control (ART) controls

Overview of distance cruise control (ART) controls



## Function description: distance cruise control (ART)



To select distance cruise control (option) or combined drive/brake cruise control



To activate and set current speed/to increase set speed



To activate and resume stored speed/to reduce set speed

LIM

To select the variable speed limiter (Temposet)

OFF

To deactivate distance cruise control

### Function description: distance cruise control (ART)

#### Functions:

- General information
- Activation conditions/function principle
- Stop-and-go assist (option)

#### General information

Ever more congested roads and thus frequent changes in driving speed are making the use of conventional cruise control practically impossible. The driver is forever having to adjust the set cruising speed or is forced to reactivate it continually due to repeated brake applications.

Distance cruise control has been introduced to relieve the strain on the driver, especially in long periods of heavy, slow or stop/start traffic. In conjunction with the brake system, it supplements the integrated continuous braking function equipped as standard.

Distance cruise control uses a radar sensor to detect traffic up to 200 m in front of the bus. The system monitors the distance to the vehicle in front and records the difference in speed at which this vehicle is driving. Any changes are evaluated accordingly.

Through integration into the complete vehicle electronics network, it has been possible to develop an automatic control system that adapts the distance from the vehicle in front by acceleration and deceleration without any input from the driver.

#### Activation conditions/function principle

Distance cruise control regulates the speed of the bus and assists the driver by automatically maintaining a specified distance from a vehicle detected in front. If no vehicle is driving in front, distance cruise control functions like drive cruise control in the speed range between 15 and 100 km/h. As soon as a vehicle is detected in front, it becomes functional in the speed range from 15 to 100 km/h

### Function description: distance cruise control (ART)

(or between 0 and 100 km/h with stop-and-go assist).

Whenever distance cruise control detects a slower vehicle in front, it will decelerate the bus and maintain the specified distance that you have selected.

Distance cruise control brakes the bus using the continuous brake when

- the bus exceeds the set cruising speed inclusive of selected speed tolerance, e.g. on a downhill gradient.
- a slower vehicle is detected in front

To maintain the specified distance, distance cruise control may attempt to achieve additional braking power by applying the service brake. As soon as the vehicle in front is no longer detected, e.g. due to a change of lane, the bus will accelerate to the selected cruising speed.

Distance cruise control cannot be activated or will be deactivated automatically if

- you are driving slower than 15 km/h on a downhill/uphill gradient steeper than 10 %
- you are driving slower than 5 km/h and no vehicle has been detected in front (with stop-and-go assist (option))
- you shift the transmission to the neutral position for longer than approximately 5 seconds
- you shift into reverse gear
- the bus is stationary and you vacate the driver's seat (with stop-and-go assist (option))
- the bus is not at driving ride height
- a malfunction occurs in the brake system/electronics
- initialisation of the distance sensor has not yet completed

### Stop-and-go assist (option)

The pull-away function of distance cruise control automates the starting and stopping process in congested traffic. If the dwell time in stop-and-go traffic is less than 2 seconds, the bus will move off again without any need for accelerator pedal inputs.



#### Note:

For notes on operation, refer to “Activating distance cruise control (ART) while the bus is stationary”.



## Activating distance cruise control (ART) (option) while the bus is in motion

### Activating distance cruise control (ART) (option) while the bus is in motion

**i** **Note:**

The distance to the vehicle in front can be reduced, e.g. if you wish to overtake. To do this, depress the accelerator pedal. When the overtaking manoeuvre is over, release the accelerator pedal again. Distance cruise control will then regulate the speed of the bus to maintain the specified distance stored.

**!** **Danger.**

If the bus is being braked by the continuous brakes (either by cruise control or by the driver using the retarder lever) while cruise control is active, depressing the service brake pedal will not cause cruise control to switch off, i.e. when the brake pedal is released, the bus will accelerate to the selected cruising speed again.



This symbol indicates that a continuous brake is active

- ▶ “- - - km/h” appears on the display screen if the request to activate distance cruise control or combined drive/brake cruise control is invalid.



M46.00-0200-71

- ▶ Press button (5).

**i** **Note:**

Drive/brake cruise control or distance cruise control (option) is now selected.



On the display screen, the corresponding symbol is shown in grey.

### Activating distance cruise control (ART) (option) while the bus is in motion



#### Note:

Press button (5) again if necessary until the corresponding symbol for distance cruise control appears on the display screen.

- ▶ Drive at the desired speed and press button (6).



#### Note:

Distance cruise control (option) is now active and the current speed is maintained even if the accelerator pedal is released.

On the display screen, the corresponding symbol is shown in white.



M54\_00-1974-71

“Abstandsregeltempomat” (Distance cruise control) pop-up window (1) opens. The current road speed (2) is set and now shown as the stored cruising speed together with symbol (3) for the driving system, which is displayed in the lower permanent display field.



#### Note:

In addition, the specified distance from the vehicle in front is set to a medium distance. The specified distance can be changed to any of 5 distances - refer to “Setting the specified distance”.



#### Note:

Repeated and brief pressing of button (6) (< 0.5 seconds) = set speed increased in increments of 0.5 km/h.



#### Note:

Repeated and brief pressing of button (8) (< 0.5 seconds) = set speed reduced in increments of 0.5 km/h.

Activating distance cruise control (ART) (option) while the bus is in motion



**Note:**

Pressing and holding button (6) for longer than 0.5 seconds accelerates the bus and increases the cruising speed in increments of 5 km/h. When the combination switch is released, the selected value is set as the new cruising speed.



**Note:**

Pressing and holding button (8) for longer than 0.5 seconds decelerates the bus and decreases the cruising speed in increments of 5 km/h. When the combination switch is released, the selected value is set as the new cruising speed.

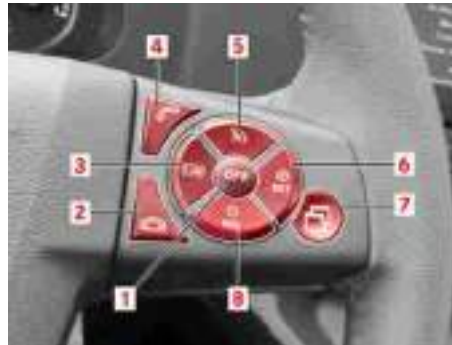

M46.00-0200-71

- ▶ Press “OFF” button (1).

Distance cruise control is deactivated. The driving system's operating display symbol in the lower permanent display field of the display screen appears in grey again. However, the previously set speed remains stored, also appears in grey and can be resumed by use of button (8).

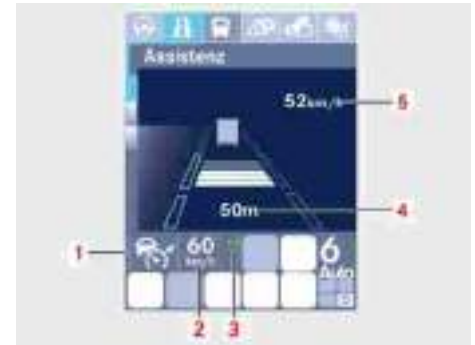

M54\_00-1976-71

- ▶ Distance cruise control on standby



**Note:**

If a cruising speed has already been stored but distance cruise control is not currently active, actual distance (4) and the speed of a vehicle in front (5) (if measured) as well as stored cruising speed (2) and speed tolerance (3) are shown in grey.

### Activating distance cruise control (ART) while the bus is stationary (only with stop-and-go assist (option))



#### Note:

The corresponding symbol (1) for the selected driving system is also shown in grey.



M46.00-0200-71

- ▶ It is possible to resume the stored speed by pressing button (8).

### Activating distance cruise control (ART) while the bus is stationary (only with stop-and-go assist (option))



#### Note:

If you wish to activate distance cruise control while the bus is stationary, do this only on major roads such as dual carriageways and not in urban traffic. This function is not designed for use in urban traffic. While the bus is stationary, it is not possible to activate distance cruise control unless a vehicle has been detected in front.

- ▶ Apply the parking brake or service brake



M46.00-0200-71

- ▶ Select distance cruise control using button (5).
- ▶ Press button (8) briefly.



#### Note:

Distance cruise control is active and the last stored speed is set as the cruising speed.

## Activating distance cruise control (ART) while the bus is stationary (only with stop-and-go assist (option))



On the display screen, the corresponding symbol and the set speed are shown in white.

- ▶ Release the parking brake or service brake.

**i** **Note:**

Distance cruise control prevents the vehicle from rolling away.

The display screen in the instrument cluster shows the red “Feststellbremse einlegen” (Apply parking brake) event window if the bus is stationary and you vacate the driver's seat (release the belt buckle) or switch off the engine while distance cruise control/stop-and-go assist is still active.

**!** **Danger.**

The braking effect of distance cruise control is cancelled and the vehicle could roll away if you deactivate distance cruise control, vacate the driver's seat, depress the accelerator pedal or press button (8). Before you disembark or switch off the vehicle, always deactivate distance cruise control and apply the parking brake to secure the vehicle against rolling away.

- ▶ To pull away, briefly depress the accelerator pedal or press button (8).

The bus pulls away and adapts its speed to that of the vehicle in front but no higher than the desired and set cruising speed.

**i** **Note:**

If the dwell time in stop-and-go traffic is less than 2 seconds, the bus will move off again without any need for accelerator pedal inputs.

**i** **Note:**

In order for the bus to pull away automatically, the following conditions must be fulfilled: The vehicle in front must drive on or already be further than 10 m away. Forward gear selected. Continuous brake deactivated. Parking brake and service brake released.

Whenever distance cruise control detects that the vehicle in front is stopping, it will decelerate the bus to a complete stop. The bus stops at a reasonable distance from the vehicle in front based on the specified distance that has been selected.

**!** **Danger.**

Even if the bus is stationary, never disembark while distance cruise control is still active. Distance cruise control is not a substitute for the parking brake and must not be used for parking.

### Setting the specified distance

#### Setting the specified distance



#### Note:

The specified distance from a vehicle in front can be set to any of 5 distances. With the basic setting (after ignition "ON"), the distance corresponds to a value approximately 60% of the speedometer value (kilometre units). This means that the distance is approximately 60 metres at a speed of approximately 100 km/h, and approximately 30 metres at a speed of 50 km/h.



#### Note:

Distance cruise control must be activated (refer to "Activating distance cruise control").



M46.00-0200-71

- ▶ Press button (7) repeatedly until the "ACC Abstand" (ACC distance) menu window is displayed.



M54\_00-1975-71

- The specified distance currently set is represented by a series of bars.



#### Note:

The number of segments shown in white corresponds to the specified distance factor currently selected.



**Note:**

The menu window closes automatically if the button is not pressed again within 10 seconds.



M46.00-0199-71

- ▶ Adjust the specified distance using arrow buttons (4) and (8).

The bar gauge displays the specified distance currently selected.



**Note:**

The more white bars there are, the greater the specified distance.

- ▶ To close the input window, press the “OK” button.



**Note:**

The specified distance selected is stored automatically after 3 seconds.

### Vehicle ahead detected

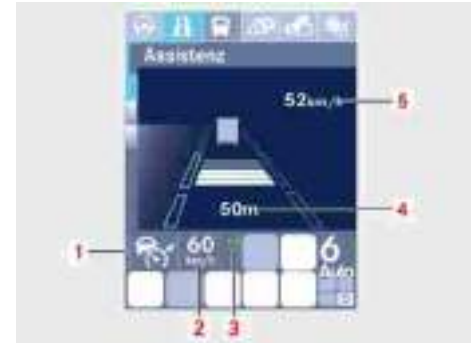

M54\_00-1976-71

- ▶ Whenever the distance cruise control radar detects a vehicle in front, the actual distance (4) to this vehicle and its speed (5) are displayed in the “Assistenz” (Assistance) main menu.



**Note:**

The actual distance and speed are displayed regardless of which driving system is currently selected and whether this driving system is active or not.

### How to respond to a distance warning



#### Note:

Whenever distance cruise control (ART) is active, Auto (1) in the lower permanent display field appears in white. In this way, the driver can see that ART is governing the distance to the vehicle in front regardless of which menu is currently on the screen.



#### Note:

If Auto remains grey even though ART is active, this means that no vehicle has been detected in front. Accordingly, no distance or speed can be displayed in this case.

#### How to respond to a distance warning



#### Danger.

Distance cruise control works only in response to vehicles travelling in front. It does not respond to stationary obstacles on the road, e.g. broken-down vehicles or traffic congestion. If a stationary obstacle is encountered, the bus will not be braked automatically. Only a distance warning may be displayed.



#### Danger.

Distance cruise control decelerates the bus automatically to maintain the set distance to the vehicle travelling in front. Distance cruise control will be activated if a vehicle in front changes lanes, for example. However, the control intervention is limited by the maximum deceleration it is able to provide. If a higher rate of deceleration is required, an automatic distance warning appears on the display screen and a double warning tone sounds.

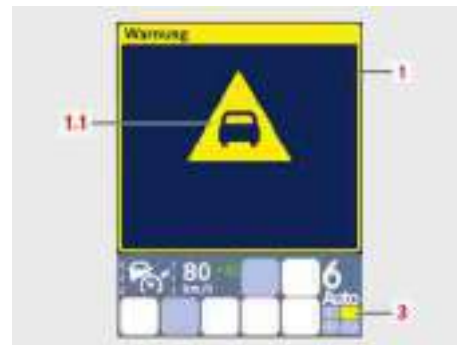

M54\_00-1977-71

- It is absolutely essential that the driver brake the bus manually using the service brake whenever an automatic distance warning is issued.



#### Note:

A pop-up window (1) appears and a double warning tone also sounds. In addition, operating display (3) in the lower permanent display field turns yellow.



## Operating displays: distance cruise control

**Danger.**

Pay even closer attention to the traffic situation if a distance warning is issued while the bus is in motion. Brake the bus using the service brake if necessary.

**Danger.**

No automatic control of distance (automatic braking) takes place, i.e. it is necessary to decelerate the bus manually using the service brake. The system cannot always interpret complex driving situations unequivocally. This may result in false warnings or no warnings at all.

**Note:**

The pop-up window is displayed for a minimum of 10 seconds and until the hazardous situation is over.

## Operating displays: distance cruise control

## Distance cruise control (ART) brake request

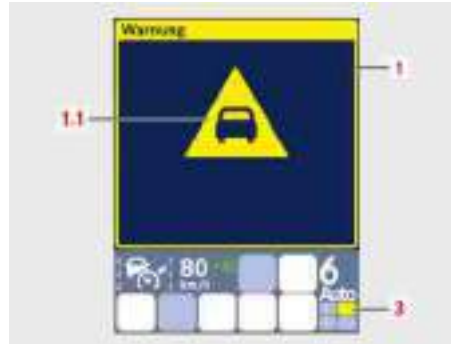

M54\_00-1977-71

This warning appears on the display screen in conjunction with a yellow warning level malfunction if distance cruise control detects that the maximum rate of deceleration provided by the system would not be sufficient to prevent a collision at the current driving speed. A double warning tone also sounds.

**Danger.**

Pay even closer attention to the traffic situation if a distance warning is issued while the bus is in motion. Brake the bus using the service brake if necessary.

**Danger.**

No automatic control of distance (automatic braking) takes place, i.e. it is necessary to decelerate the bus manually using the service brake. The system cannot always interpret complex driving situations unequivocally. This may result in false warnings or no warnings at all.

### Active Brake Assist (ABA) (system description)

#### Active Brake Assist (ABA) (system description)

Active Brake Assist (ABA) is an assistance system for critical driving situations. Active Brake Assist can help to minimise the risk of colliding with the vehicle in front or at least reduce the severity of accident.

Active Brake Assist is merely an aid to assist the driver.

Whenever Active Brake Assist detects a hazardous situation, the driver is alerted by an audible and a visual warning.

If there is a risk of a collision, the warning level is escalated and automatic partial braking of the vehicle is initiated.

If the driver does not react to the warnings, Active Brake Assist automatically initiates emergency braking (full brake application).



#### Note:

If distance cruise control is active, the warnings of distance cruise control are issued before those of Active Brake Assist. The warnings of Active Brake Assist are still issued if distance cruise control is not active.



#### Danger. Risk of accident.

Active Brake Assist does not relieve you of the responsibility for adopting a driving style which takes traffic and road conditions into account. Deceleration by Active Brake Assist may not be sufficient to prevent a collision with the vehicle in front.

The driver is always responsible for the speed driven, for initiating braking or evasive manoeuvres in good time and for maintaining a safe distance from the vehicle in front. If Active Brake Assist cannot interpret a traffic situation unequivocally, it always transfers responsibility for braking the vehicle to the driver. For this reason, you should never rely on Active Brake Assist to brake the vehicle in every situation. Do not wait until Active

Brake Assist initiates full braking. In the following situations, you should brake the bus manually using the service brake:

- If the distance warning icon appears on the display screen.
- If a continuous and intermittent warning tone sounds.
- If a continuous and intermittent warning tone sounds and automatic partial braking has been initiated.



#### Danger. Risk of accident.

Active Brake Assist cannot always interpret complex driving situations unequivocally. Active Brake Assist is able to issue warnings and brake the vehicle only when objects are identified unequivocally. Object recognition may be particularly impaired if the distance sensor is dirty or otherwise covered. This may also be the case in snow or heavy rain. Active Brake Assist does not react to persons, animals, oncoming vehicles or cross traffic. Active Brake Assist may fail to detect narrow vehicles, e.g. motorcycles.

If no visual and/or audible warning is given in a critical situation,

## Activation/deactivation of Active Brake Assist (automatic)

- Active Brake Assist has not detected the hazardous nature of the situation
- Active Brake Assist is switched off
- Active Brake Assist has failed.
- Brake the bus using the service brake.

**Danger. Risk of accident.**

If Active Brake Assist has already initiated emergency braking, it is possible to cancel this braking by kickdown (depressing the accelerator pedal beyond the pressure point) or by pressing the Active Brake Assist pushbutton.

If you do not receive a visual or audible warning in a critical situation, Active Brake Assist has either failed to detect the danger, is deactivated or has malfunctioned. Brake the bus using the service brake. Active Brake Assist cannot always interpret complex driving situations unequivocally. If, in a non-critical situation, a visual and/or audible warning is issued or partial braking is initiated, you can deactivate the system by operating

- the turn signal switch,

- the brake pedal,
- the accelerator pedal or
- the Active Brake Assist pushbutton.

**Activation/deactivation of Active Brake Assist (automatic)**

Active Brake Assist is activated automatically.

- Insert the vehicle key and briefly press the “Start/Stop” pushbutton. The indicator lamp in the Active Brake Assist pushbutton goes out.

Active Brake Assist is deactivated automatically

- if the chassis frame is not at normal level (raised, lowered),
- in the event of a malfunction in the Active Brake Assist electronics system,
- in the event of a malfunction in the vehicle's brake system.

### Deactivating Active Brake Assist (ABA) (manually)

#### Deactivating Active Brake Assist (ABA) (manually)



M54.00-1943-71

Press Active Brake Assist pushbutton (1).  
Active Brake Assist is deactivated.



M54\_00-1979-71

This indicator lamp (2) lights up in the instrument cluster. Active Brake Assist is not available. There will be no automatic braking of the bus in a critical situation.



#### **Danger.**

Responsibility for the safe control and operation of a vehicle always lies with the driver. The risks of an accident cannot be effectively reduced unless Active Brake Assist (ABA) is active.



#### **Note:**

Active Brake Assist is reactivated automatically the next time the engine is started.



### Sequence of events when emergency braking initiated by Active Brake Assist (ABA)

Sequence of events when emergency braking initiated by Active Brake Assist (ABA)

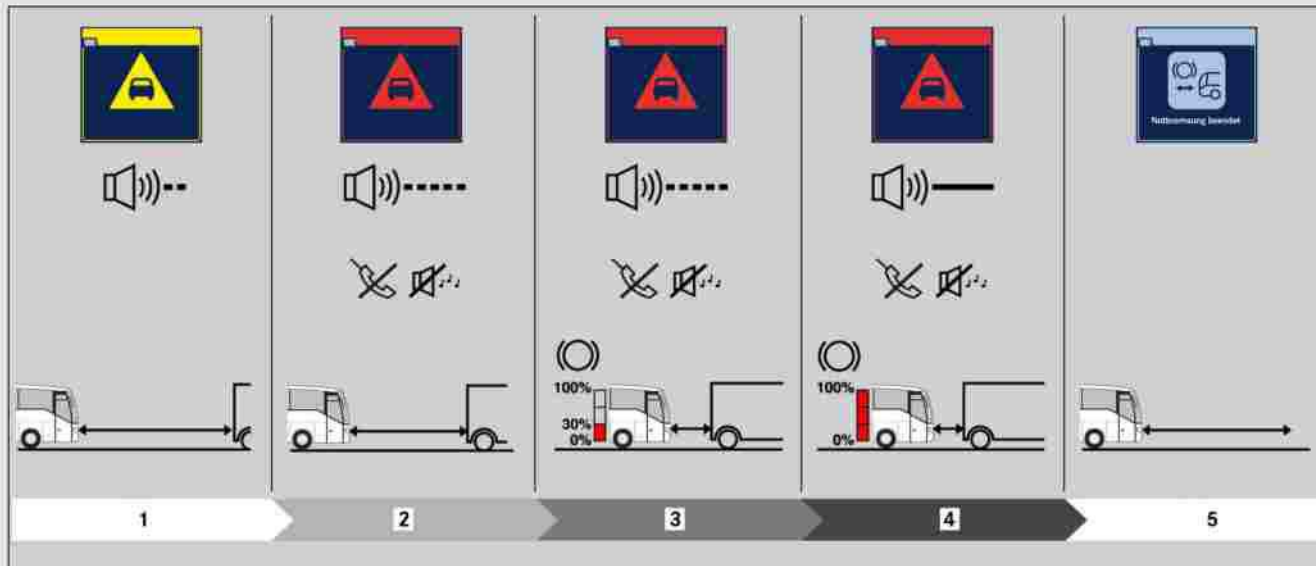

Function description: warning levels and emergency braking

1 ART (distance cruise control) warning level (preliminary warning level)

2 ABA warning level: “Critical situation”

3 ABA warning level: “Very critical situation” (partial brake application)



**Note:**

Brake lamps lit.

4 Emergency braking (full brake application)



**Note:**

Flashing brake lamps.

5 End of emergency braking



**Note:**

Hazard warning lamps activated.

**Function description: warning levels and emergency braking**

**Functions:**

- Distance warnings
- ART (distance cruise control) warning level (preliminary warning level)
- ABA warning level: “Critical situation”
- ABA warning level: “Very critical situation” (partial brake application)
- Emergency braking (full brake application)
- Cancelling emergency braking
- End of emergency braking

**Distance warnings**

If a distance warning is issued while the bus is in motion:

- Pay even closer attention to the traffic situation.
- Brake the vehicle using the service brake.



**Note:**

The visual distance warning is issued even if Active Brake Assist has been deactivated.



**Note:**

To prevent unnecessary distance warnings and partial brake applications being issued and initiated by Active Brake Assist, the driver is able to intervene actively to suppress them.



**Note:**

The telephone and radio are muted for the duration of the audible warning.

## Function description: warning levels and emergency braking

**ART (distance cruise control) warning level (preliminary warning level)**



M54\_00-1977-71

Yellow alert (1) appears on the display screen in conjunction with icon (1.1) and yellow alert (3).



**Note:**

A double warning tone also sounds.

**ABA warning level: “Critical situation”**

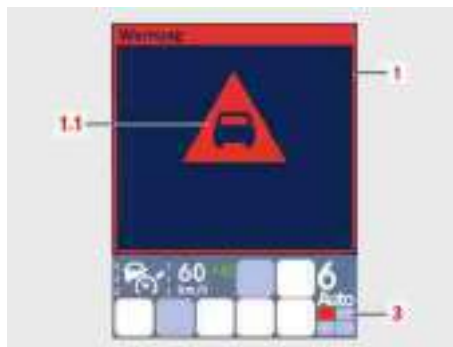

M54\_00-1978-71

Red alert (1) appears on the display screen in conjunction with icon (1.1) and red alert (3).



**Note:**

At the same time, an intermittent warning tone sounds continuously.

**ABA warning level: “Very critical situation” (partial brake application)**

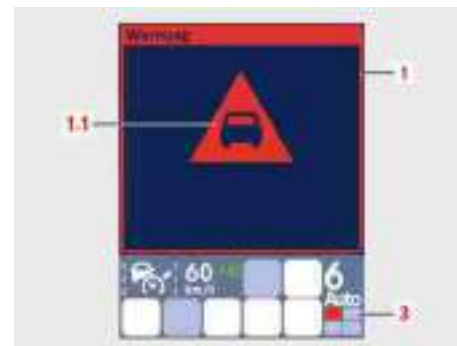

M54\_00-1978-71

Red alert (1) appears on the display screen in conjunction with icon (1.1) and red alert (3).



**Note:**

At the same time, an intermittent warning tone sounds continuously. In addition, Active Brake Assist brakes the vehicle with an automatic partial brake application. The vehicle is braked with approximately 30 % of maximum braking power.



## Function description: warning levels and emergency braking

**Note:**

The brake lamps come on automatically as soon as partial braking is initiated.

The driver is able to intervene actively by, for example, operating the

- Brake pedal
- Turn signals
- Active Brake Assist OFF pushbutton
- Accelerator pedal
- Kickdown (depressing the accelerator pedal beyond the pressure point).

If the driver actively intervenes during an automatic distance warning or partial brake application, the audible distance warnings of Active Brake Assist are suppressed.

**Note:**

The visual distance warnings continue to be displayed. Partial braking is cancelled.

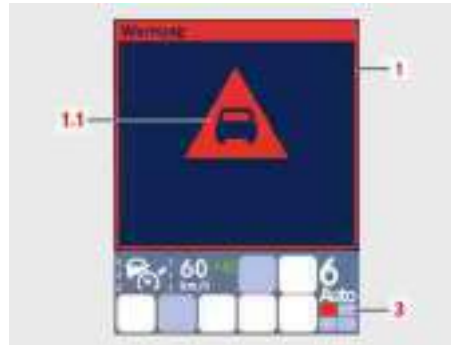

M54\_00-1978-71

Red alert (1) continues to be displayed on the display screen together with icon (1.1) and red alert (3) until the hazardous situation is over.

### Emergency braking (full brake application)

(only if the object in front is a vehicle - other stationary obstacles result in partial braking only)

If the driver does not react to the distance warnings and partial brake application, Active Brake Assist automatically initiates emergency braking (full brake application). Active Brake Assist brakes the vehicle with the maximum braking power of the vehicle.

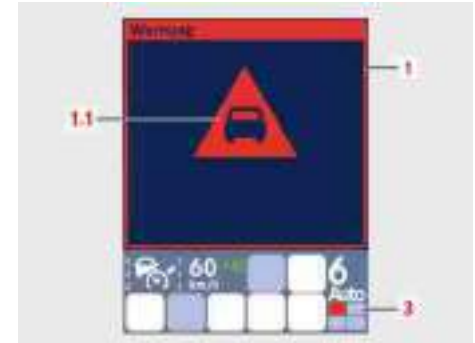

M54\_00-1978-71

During emergency braking, red alert (1) is displayed on the display screen together with icon (1.1) and red alert (3).

### Function description: warning levels and emergency braking



#### Note:

At the same time, a continuous warning tone sounds.



#### Note:

If emergency braking is initiated at a speed of over 50 km/h, the brake lamps are controlled by a pulse signal. This means that the brake lamps are seen to flash.

### Cancelling emergency braking

It is possible to cancel emergency braking:

- by pressing the Active Brake Assist pushbutton
- or by depressing the accelerator pedal beyond the pressure point (kick-down).

### End of emergency braking

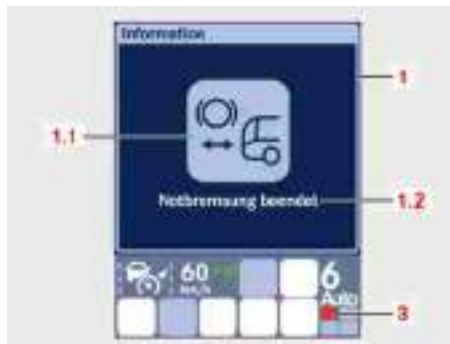

M54\_00-1981-71

This alert (1) appears on the display screen in conjunction with icon (1.1) and the message “Notbremsung beendet!” (End of emergency braking!) (1.2). A warning tone also sounds.



#### Danger.

If the vehicle has been emergency braked to a halt, it will continue to be held stationary for a further 3 seconds by the service brake unless the driver intervenes.



#### Note:

The hazard warning lamps will switch on automatically if the vehicle is braked to a halt by Active Brake Assist from a speed of over 50 km/h.

The following points must be observed following an emergency braking event:

- Manoeuvre the vehicle out of the danger zone as soon as possible, traffic conditions permitting.
- Switch off the hazard warning lamps.
- Switch off the engine and apply the parking brake to secure the vehicle against rolling away.
- The driver must inspect the vehicle for roadworthy condition and check the health and condition of passengers.

## Operating/malfunction displays: Active Brake Assist (ABA)

### Operating/malfunction displays: Active Brake Assist (ABA)

#### Active Brake Assist deactivated



M54\_00-1979-71

When this indicator lamp (2) in the instrument lights up, Active Brake Assist has been manually deactivated by the driver pressing the pushbutton on the instrument panel.

### Active Brake Assist malfunction display



M54\_00-1982-71

In the event of an Active Brake Assist malfunction, yellow alert (1) appears on the display screen in conjunction with icon (1.1) and the message “Active Brake Assist nicht verfügbar” (Active Brake Assist not available) (1.2). At the same time, a brief warning tone sounds and yellow alert (3) is displayed.



#### Note:

Active Brake Assist is not available, which means that the vehicle would not be braked automatically in a critical situation.



#### Danger.

If Active Brake Assist cannot be activated, no distance warnings will be issued. There will be no automatic braking of the bus in a critical situation. Pay even closer attention to the traffic situation. Have Active Brake Assist checked and repaired at a qualified specialist workshop which has the necessary specialist knowledge and tools to carry out the work required. EvoBus recommends an OMNIplus Service Partner for this purpose. In particular, if the work is relevant to safety or involves safety-related systems, it is essential that the service be carried out at a qualified specialist workshop.

## Operating/malfunction displays: Active Brake Assist (ABA)

### Active Brake Assist cannot be activated

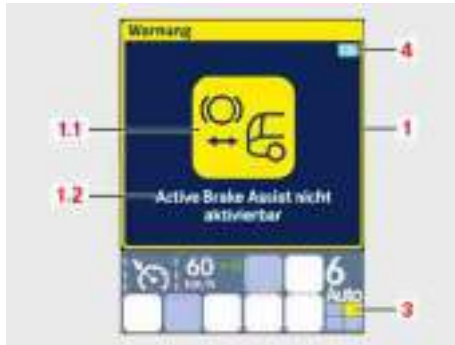

M54\_00-1983-71

If Active Brake Assist cannot be activated, alert (1) appears on the display screen in conjunction with icon (1.1) and the message “Active Brake Assist nicht aktivierbar” (Active Brake Assist cannot be activated) (1.2).



### Note:

This message appears if an attempt has been made to activate Active Brake Assist using the ABA pushbutton on the instrument panel but the system is not available due to a malfunction.



### Danger.

If Active Brake Assist cannot be activated, no distance warnings will be issued. There will be no automatic braking of the bus in a critical situation. Pay even closer attention to the traffic situation. Have Active Brake Assist checked and repaired at a qualified specialist workshop which has the necessary specialist knowledge and tools to carry out the work required. EvoBus recommends an OMNIplus Service Partner for this purpose. In particular, if the work is relevant to safety or involves safety-related systems, it is essential that the service be carried out at a qualified specialist workshop.

### Distance warning/emergency braking icon

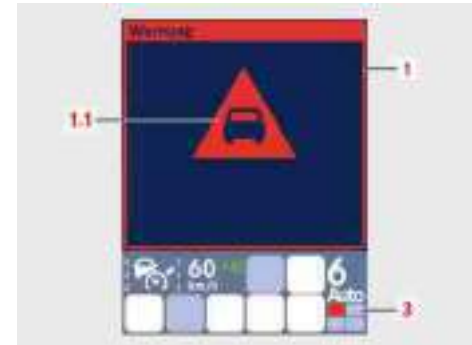

M54\_00-1978-71

A yellow or red alert (1) appears on the display screen in conjunction with icon (1.1) and yellow or red warning lamp (3) if distance cruise control or Active Brake Assist detects that the maximum rate of deceleration provided by the system would not be sufficient to prevent a collision at the current driving speed. Similarly, red alert (1) appears on the display screen in conjunction with icon (1.1) and red warning lamp (3) if Active Brake As-

## Operating/malfunction displays: Active Brake Assist (ABA)

sist has initiated emergency braking (full brake application).

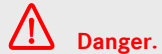

**Danger.**

Pay even closer attention to the traffic situation if a distance warning is issued while the bus is in motion. Brake the bus using the service brake if necessary.



**Note:**

The visual distance warning on the display screen is issued even if Active Brake Assist has been deactivated.

### Icon indicating end of emergency braking

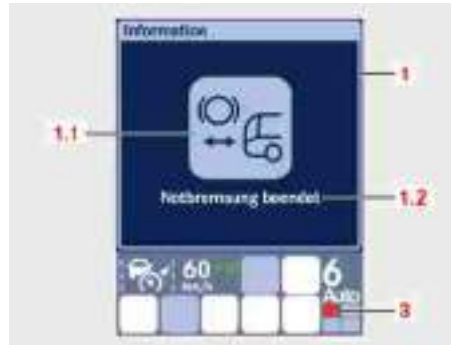

M54\_00-1981-71

This alert (1) appears when the emergency braking application has ended. Alert (1) displays icon (1.1) and the message "Notbremsung beendet!" (End of emergency braking) (1.2).



**Danger.**

If the vehicle has been emergency braked to a halt, it will continue to be held stationary for a further 3 seconds by the service brake unless the driver intervenes.



**Note:**

The hazard warning lamps will switch on automatically if the vehicle is braked to a halt by Active Brake Assist from a speed of over 50 km/h.

### Special driving situations with distance cruise control/Active Brake Assist

#### Special driving situations with distance cruise control/Active Brake Assist

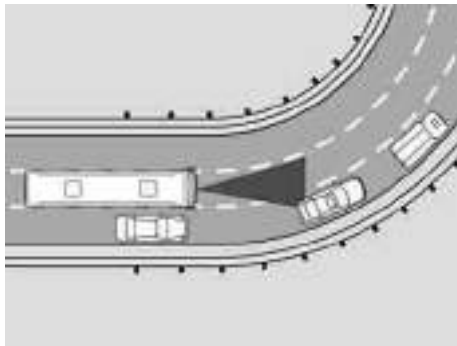

M54\_00-1004-01

Cornering, entering and exiting corners



**Danger.**

When the bus is cornering or being driven into or out of a corner, distance cruise control and Active Brake Assist may not always detect vehicles in front unequivocally. The bus may issue warnings in response to vehicles detected in a different lane and braking could be initiated unnecessarily or too late. For these reasons,

ons, pay even closer attention to traffic conditions when cornering.

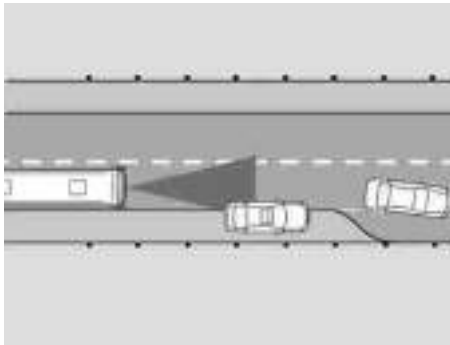

M54\_00-1005-01

Exit sliproads, driving on a different line, hard shoulders



**Danger.**

Distance cruise control and Active Brake Assist may not always detect vehicles in front unequivocally at exit sliproads or where other vehicles pull out, are driving on a different line or are driving or parked on the hard shoulder. As a result, your vehicle could be braked automatically even though the vehicle in front is

only partly in your lane. For these reasons, pay even closer attention to traffic conditions at exit sliproads or where other vehicles are driving on a different line or are driving or parked on the hard shoulder.

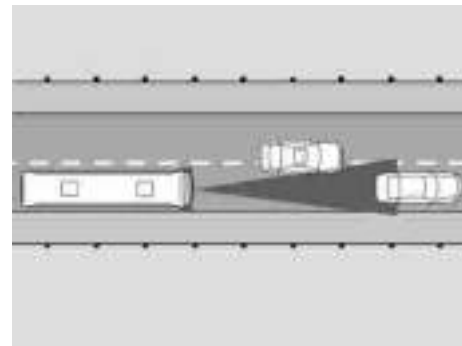

M54\_00-1006-01

Entry sliproads, driving on a different line, lane change

## Special driving situations with distance cruise control/Active Brake Assist

**Danger.**

Distance cruise control and Active Brake Assist may not always detect vehicles in front unequivocally at entry sliproads or where other vehicles are driving on a different line or cut in. The distance sensor may react too late to vehicles that are driving on a different line or that suddenly cut in. It may be necessary to brake the bus using the service brake in order to maintain a safe distance from the vehicle that is driving on a different line or to ease back from a vehicle that suddenly cuts in. For these reasons, pay even closer attention to traffic conditions at entry sliproads or where other vehicles are driving on a different line or are driving or parked on the hard shoulder.

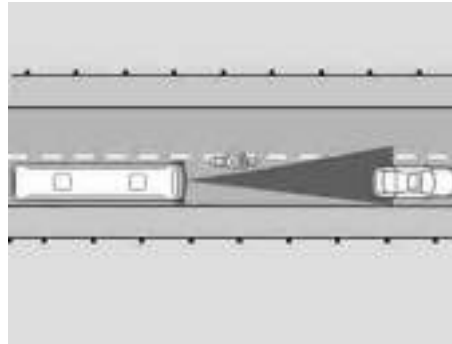

M54\_00-1007-01

Vehicles cutting in

**Danger.**

Vehicles that cut into your lane without maintaining a safe distance will not be detected by distance cruise control until they have encroached into the detection range of the sensor. There is not enough of a gap between the bus and the vehicle that is cutting in. You must be prepared to brake the bus using the service brake in order to ease back from the vehicle that is cutting in.

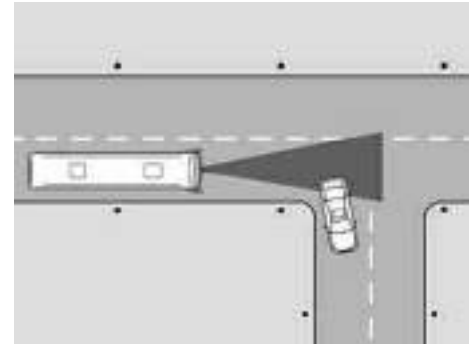

M54\_00-1008-01

Vehicles turning off

**Danger.**

At intersections, entry sliproads and exit sliproads, distance cruise control and Active Brake Assist may not always detect vehicles in front unequivocally. For example, your own vehicle may issue warnings in response to vehicles turning off and braking could be initiated unnecessarily or too late. For these reasons, pay even closer attention to traffic conditions at intersections, entry sliproads and exit sliproads.

### Special driving situations with distance cruise control/Active Brake Assist

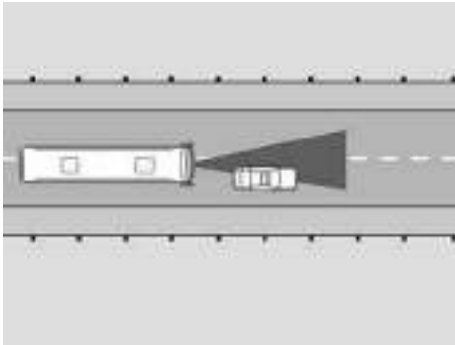

M54\_00-1009-01

#### Overtaking



**Danger.**

A distance warning could be issued if you begin to overtake but approach the vehicle in front whilst still in the same lane. Your vehicle could be braked automatically in order to increase the distance to the vehicle in front. For this reason, be sure to change lane fully before increasing speed to overtake the vehicle in front.

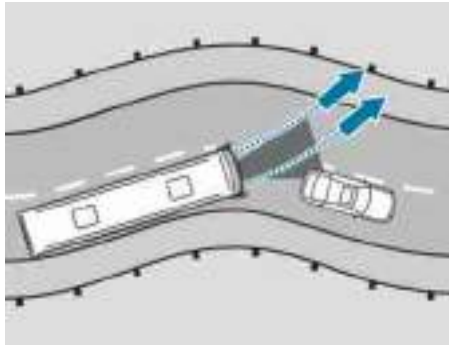

M54\_70-0006-71

#### Snaking roads



**Danger.**

On snaking roads, distance cruise control and Active Brake Assist may not always detect vehicles in front unequivocally. The distance sensor may not detect that the vehicle in front is in the same lane as you. You must be prepared where necessary to brake the bus using the service brake in order to increase the distance from the vehicle ahead. For these reasons, pay even closer attention to traffic conditions on snaking roads.

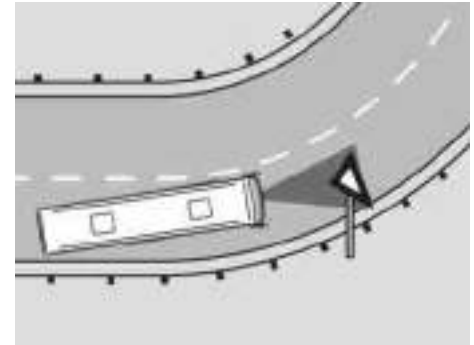

M54\_70-0005-71

#### Standing objects

Examples of standing objects:

- Posts
- Crash barriers on the outside of a bend
- Traffic signs projecting into the carriageway
- Bridges



## Special driving situations with distance cruise control/Active Brake Assist

**Danger.**

For these reasons, pay even closer attention to traffic conditions when cornering and when approaching standing objects because no automatic braking will be initiated.

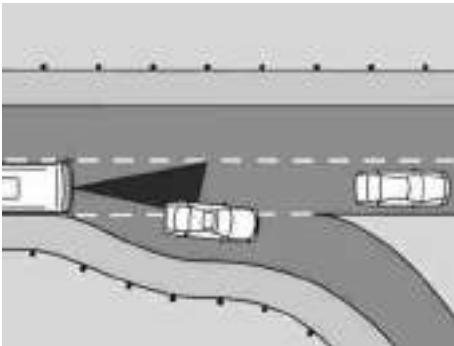

M54\_70-0032-01

Vehicles on entry and exit sliproads or intersections

**Danger.**

Distance cruise control and Active Brake Assist may not always detect vehicles in front at intersections, entry sliproads or exit sliproads unequivocally. Where vehicles join your lane, warnings may not be issued at all, and braking may not be initiated, because the target could not be acquired in time even though it may have already encroached into your lane. Where vehicles leave your lane, a delayed visual loss of the target could result in brief warnings and braking being initiated even if the vehicle has already arrived in the next lane.

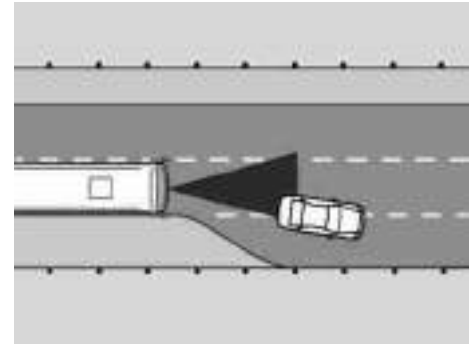

M54\_70-0031-01

Warning in response to vehicles pulling out of your lane

**Danger.**

In instances where the vehicle in front pulls out of your lane, it is common for the speed of this vehicle to decrease before it has fully arrived in the adjacent lane. On the one hand, the distance to this vehicle decreases; on the other hand, the speed differential increases. This may result in an ART warning. Since ART responds very rapidly and promptly by decelerating your own vehicle, the situation is alleviated in time for intervention by

### Important information on the lane assistant warning system (option)

ABA to be avoided. Vehicles turning off or pulling out of your lane when cornering may amplify this effect further still. Through bends, including approach and exit, the vehicle that pulled out of your lane may continue to be recorded by the sensor (albeit possibly for only a brief period) even though it has already arrived in the adjacent lane.

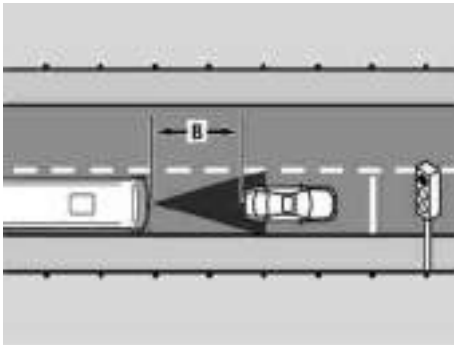

M54\_70-0030-01

Warning in response to vehicles stopping



**Danger.**

In isolated cases, ABA distance warnings may be issued while the vehicle in front is coming to a halt, e.g. if the vehicle in front brakes erratically or both suddenly and powerfully with the effect that the distance to this vehicle (B) decreases temporarily. Often, this behaviour cannot be perceived by the driver (e.g. stopping at traffic lights or at the back end of a traffic jam).

### Important information on the lane assistant warning system (option)

The lane assistant warning system is a convenience system that continuously monitors the position of the bus in relation to the roadside markings by means of a camera behind the windscreen. When the lane assistant warning system is active, the driver is warned if the bus drives on or over road lane markings by a vibration in the driver's seat cushion.



**Danger.**

The lane assistant warning system is merely an aid to assist the driver. The driver is responsible at all times for maintaining the vehicle's direction of travel and making sure that it remains in the correct lane.

## Important information on the lane assistant warning system (option)

 **Danger.**

The lane assistant warning system can only give a warning when the bus drives on or over road lane markings if these markings are easily detectable.

 **Note:**

The driver's seat should not be covered with thicker cushions or mats, otherwise it may not be possible to feel the vibrations generated by the integral motors.

 **Note:**

An icon appears on the display screen if no warning is possible when the lane assistant warning system is activated.

 **Danger.**

Unfavourable weather conditions, such as snow, slush, heavy rain or heavy soiling of the windscreen may impair the function of the lane assistant warning system.

 **Danger.**

Note that the function of the lane assistant warning system is limited: if the lane markings are difficult to detect (e.g. if the road is covered by snow, sand or stones), if there are shadows or if the markings on the road are complex or difficult to distinguish (e.g. on construction sites) or on tight bends. In these conditions, the lane assistant warning system cannot give a warning as intended if the bus drives on or over the road lane markings. Make sure that the windscreen is always kept clean in the area of the camera. You should therefore switch on the windscreen wiper, for example, to keep the windscreen in the area of the camera free from dirt.

 **Danger.**

Even when activated, the lane assistant warning system does not issue warnings at speeds below 50 mph (70 km/h), when the turn signals are switched on or if the bus is being decelerated. In these situations, there will be no warning from

the lane assistant warning system if the bus is driven on or over the road lane markings. When driving, you are therefore responsible for keeping the bus in the correct lane and in the correct direction at all times.

### Warning display if lane marking crossed

#### Warning display if lane marking crossed



M54\_00-1985-71

If you drive over the lane marking, the corresponding line on the display screen turns red (1). At the same time, the line next to the symbols for the driving systems in the lower display field also turns red. This field remains visible even when a different menu is displayed on the display screen.

#### Deactivating the lane assistant warning system



##### Note:

The lane assistant warning system is automatically set to standby when the bus is started. The system is activated from a speed of 45 mph (70 km/h).



M54.00-1944-71

- ▶ To deactivate the lane assistant warning system, press “OFF” pushbutton (1) with the ignition starter switch ON.

The lane assistant warning system function is deactivated and the LED on lane assistant warning system OFF pushbutton (1) lights up.



##### Note:

It is advisable to deactivate the lane assistant warning system when driving for long periods on construction sites.

## Attention Assist - system description

**Attention Assist - system description**

Attention Assist monitors the driver's driving behaviour and creates an individual driver profile during the initial stages of every journey. The profile is then compared with the latest sensor data continuously as the journey progresses. Permanent monitoring is important because it enables the system to detect the driver's transition from alertness to drowsiness and issue warnings in good time.

The main component of the system is a high-resolution sensor for highly precise monitoring of steering movements and steering speed. Based on these data, Attention Assist establishes a behaviour pattern during the first minutes of every journey, which is then compared continuously in the vehicle's electronic control unit with the latest steering behaviour and driving situation.

In addition to driving speed and longitudinal and lateral acceleration, for example, the system also evaluates steering wheel

movements, turn signal and pedal use and other driver inputs as well as external factors such as crosswind or road surface irregularities. With these data, the system is able to detect the typical indicators of overtiredness and warn the driver accordingly.

**Attention Assist - function description****Functions:**

- General information

**General information**

Attention Assist supports the driver on long, monotonous journeys, e.g. on the motorway and other major roads. Attention Assist is active above a speed of approximately 35 mph (60 km/h).

Whenever Attention Assist detects the typical signs of drowsiness or an increasing level of driver inattention, it prompts the driver to take a break.

**Note:**

Attention Assist is merely an aid to assist the driver and may not always detect tiredness or increasing inattention reliably or in good time. Attention Assist is no substitute for a well-rested and alert driver.

### Attention Assist - function description



#### Note:

The warning generated by Attention Assist is issued independently of legally enforced rules for driving and rest times or the functions of the digital tachograph.

Attention Assist evaluates your drowsiness or an increasing level of inattention by taking the following criteria into consideration:

- Personal driving style, e.g. steering behaviour
- Journey conditions, e.g. driving time

Attention Assist functionality is restricted and a warning is given later or not at all

- if you predominantly drive slower than 35 mph (60 km/h)
- on winding roads



M68.00-0573-71

Whenever Attention Assist detects the typical signs of drowsiness or an increasing level of driver inattention

- the two seat motors vibrate (same motors used by the lane assistant warning system).
- the on-board computer displays a yellow event window (1) with the message “ATTENTION ASSIST: Pause” (Take a break).

The driver can acknowledge this message by pressing “OK” button (3) on the left-hand button pad on the steering wheel.



#### Note:

However, yellow status message (2) at the bottom of the display screen will continue to be displayed.

Take regular and timely breaks on long journeys. If you do not take a break, Attention Assist may not warn you again for at least another 15 minutes.

Attention Assist will clear its evaluation and start over when you resume the journey

- after a relatively long period at a standstill
- if you switch off the engine.

Attention Assist is always activated after an engine start. You can activate and deactivate Attention Assist in the “Systeme” (Systems) submenu in the “Einstellungen” (Settings) main menu.



**Note:**

Refer to the “Driver's area controls” section.





**Operating instructions for the air-conditioning system . . . . . 278**

**Heating/ventilation/air-conditioning (HVAC) control panel . . . . . 280**

**Manually regulating the blower speed in the driver's area . . . . . 283**

**Preselecting the passenger-compartment temperature . . . . . 284**

**Manually regulating the blower speed in the passenger compartment . . . . . 285**

**Activating the air-conditioning . . . . . 286**

**Switching on air-recirculation mode in the driver's area and passenger compartment . . . . . 287**

**Activating the reheat function . . . . . 288**

**Activating the auxiliary heating unit . . . . . 288**

**Programming auxiliary heating switch-on times . . . . . 290**

**Activating a programmed auxiliary heating switch-on time . . . . . 292**

**Deactivating an activated switch-on time . . . . . 294**

**Programming the auxiliary heating switch-on duration . . . . . 294**

**Switches/controllers in the driver's rest area . . . . . 296**

## Operating instructions for the air-conditioning system

### Operating instructions for the air-conditioning system



#### Note:

For optimum climate control in heating or cooling mode, the driver's window should remain closed while the vehicle is in motion.



#### Note:

The openings below the spare wheel in the compartment must not be sealed or covered by objects as troublefree operation of the heating, ventilation and air-conditioning system would no longer be guaranteed.



## Heating/ventilation/air-conditioning (HVAC) control panel

Heating/ventilation/air-conditioning (HVAC) control panel



## Heating/ventilation/air-conditioning (HVAC) control panel



### Note:

Switch on the ignition switch before operation.

- 1 Button for air-recirculation/fresh-air mode in the driver's area



### Note:

Integrated LED lit in air-recirculation mode - LED unlit in fresh-air mode.

- 2 Rotary knob for air distribution in the driver's area: Infinitely variable



### Note:

Air permanently flows out of the swivelling air vents in the instrument panel (driver's station) and in the forward structure (co-driver's seat) regardless of the position of the rotary knob. The airflow can be regulated manually as desired using the adjustment slide on the air vent itself.

- 2.1 Air distribution to the footwell
- 2.2 Air distribution to the footwell and windscreen
- 2.3 Air distribution to the windscreen
- 2.4 Fresh-air vent in the instrument panel
- 2.5 Defrosting the windscreen (blower automatically set to fastest speed)
- 3 Rotary knob for temperature control in the driver's area

- 4 Rocker switch for blower speed control in the driver's area
- 5 Button for temperature control in the passenger compartment



### Note:

Pressing the button for longer than 2 seconds automatically selects the optimum temperature. (LED in pushbutton (5) unlit)

- 6 Automatic A/C mode "ON/OFF" button



### Note:

LED lit in automatic A/C mode.

### Heating/ventilation/air-conditioning (HVAC) control panel

- 7 Smog button for the driver's area and passenger compartment (use, for instance, when driving through a tunnel): Passenger-compartment and driver's area ventilation switches to air-recirculation mode. The roof hatches are closed automatically.



**Note:**

The LED integrated in the button lights up.

- 8 Reheat button (use to dehumidify the vehicle interior): The air-conditioning system is switched to heating control. The recirculated air (i.e. the reduced amount of fresh air) is cooled as it comes into contact with the refrigerant heat exchanger and reheated by the heat exchanger for the heating system. This process condenses water out of the air passed through the system. The air directed to passengers or the driver is thereby dehumidified.



**Note:**

The LED integrated in the button lights up

- 9 Manual blower speed adjustment button
- 10 Preset timer button:



**Note:**

refer to "Programming the preset timer"



**Danger.**

Observe the safety precautions for operation of the auxiliary heating unit in the Operating Instructions.

- 11 Auxiliary heater "ON/OFF" button: The integrated LED indicates when the auxiliary heating unit is ready for operation (in standby). The auxiliary heating unit switches to a state of readiness only if the outside temperature is at least 6 °C below the setpoint value selected (passenger compartment).

## Manually regulating the blower speed in the driver's area



### Danger.

Observe the safety precautions for operation of the auxiliary heating unit in the Operating Instructions.

- 12 Rocker switch for adjusting values and functions of push-buttons 5/9/10:

### Manually regulating the blower speed in the driver's area

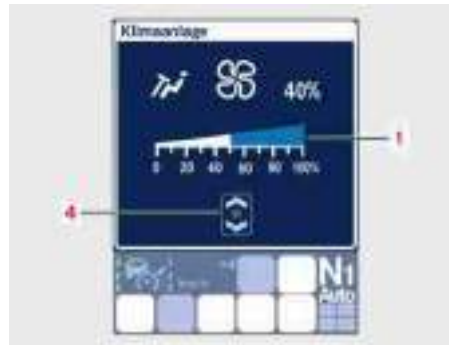

M83.00-0864-71

- ▶ Press button (4) on the control panel



### Note:

The LED in the pushbutton starts to flash

The blower speed currently set is represented by bar graph (1) on the display screen.

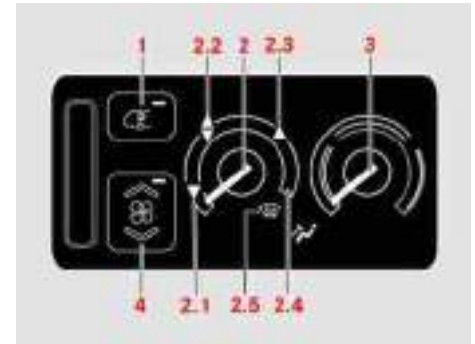

M83\_00-0783-71

- ▶ Button (4) can now be used to reduce (-) or increase (+) the blower speed.



### Note:

If button (4) is not pressed again within 10 seconds or if a different button is pressed, the indicator on the display screen is cleared and the LED in button (4) stops flashing.

## Preselecting the passenger-compartment temperature

### Preselecting the passenger-compartment temperature

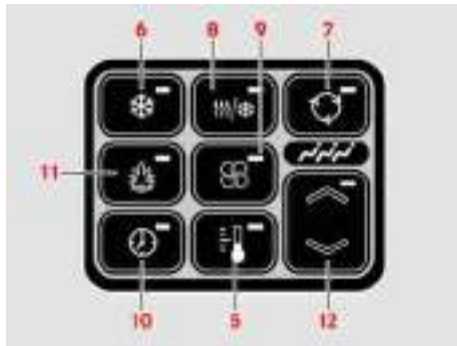

M83\_00-0117-01

- ▶ Press button (5) on the control panel.

#### **i** Note:

The LED in rocker switch (12) begins to flash.



M83.00-0865-71

The desired value currently set is represented by bar graph (1) on the display screen.

#### **i** Note:

In addition, interior temperature (2) is displayed on the display screen.

- ▶ The setpoint value for the passenger compartment can now be changed using rocker switch (12) (+ or -).

#### **i** Note:

Press the upper or lower section of button (12) repeatedly until "Komfort" (3) (Comfort = optimum value) on the display screen turns white.

#### **i** Note:

The setpoint value can be changed up or down as required with button (12). The setpoint value should only be changed in small increments.

#### **i** Note:

If button (12) is not pressed again within 10 seconds or if a different button is pressed, the indicator on the display screen is cleared and the LED in the rocker switch stops flashing. The newly entered setpoint value is stored.



## Manually regulating the blower speed in the passenger compartment



M83.00-0865-71

- ▶ Pressing button (5) for longer than 2 seconds automatically selects the optimum value.

When the optimum value has been selected, “Komfort” (Comfort) (3) turns white but the LED in pushbutton (5) remains unlit.

- ▶ If no bar graph is displayed and if “OFF” appears on the display screen, automatic regulation in the passenger compartment has been deactivated.

### Manually regulating the blower speed in the passenger compartment

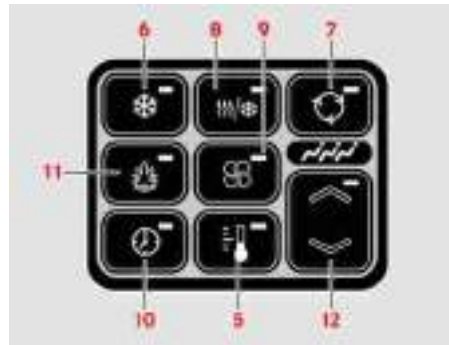

M83\_00-0117-01

- ▶ Press button (9) on the control panel



#### Note:

The LED in rocker switch (12) begins to flash.



M83.00-0866-71

- ▶ The blower speed currently set is represented by bar graph (1) on the instrument cluster display screen.
- ▶ It is now possible to adjust the ceiling blower speed to any value between 20 % and 100 % by pressing rocker switch (12) (+ or -).

## Activating the air-conditioning



### Note:

If button (9) is pressed for longer than 2 seconds, the optimum blower speed is set automatically. At optimum blower speed, the LED in pushbutton (9) remains unlit. "Auto" appears underneath the scale on the display screen.



### Note:

If button (12) is not pressed again within 10 seconds or if a different button is pressed, the indicator on the display screen is cleared and the LED in rocker switch (12) stops flashing.

### Activating the air-conditioning

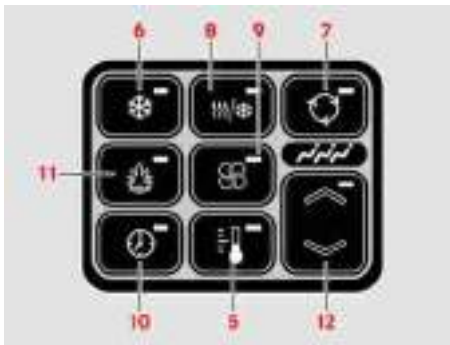

M83\_00-0117-01

- ▶ Press button (6) on the control panel.

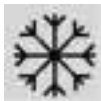

Operational readiness is indicated by the integrated LED lighting up. In addition, when the air-conditioning system is activated, the symbol above appears in the "Betriebsmeldungen" (Operating notifications) submenu on the display screen and the roof hatches are closed automatically.



### Note:

The air-conditioning system is switched on automatically after a delay depending on the desired temperature and the outside and interior temperatures.



### Note:

The status in effect at the time the ignition starter switch is switched to OFF is retained when the ignition is switched back on.



### Note:

If cooling output is inadequate in air-conditioning mode and no malfunction is indicated on the display screen, you can activate the ventilation program by switching off automatic A/C mode.



If this symbol appears on the display screen, current temperature condi-

## Switching on air-recirculation mode in the driver's area and passenger compartment

tions are preventing activation of the air-conditioning system.



If this symbol appears on the display screen, there is no air-conditioning system available.

### Switching on air-recirculation mode in the driver's area and passenger compartment

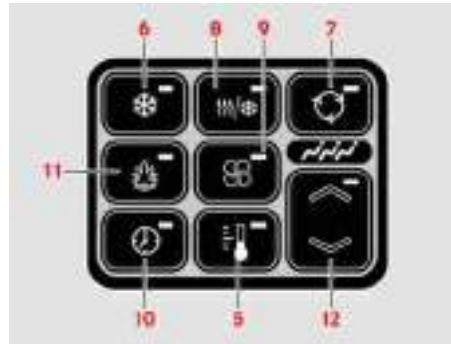

M83\_00-0117-01

- Press button (7) on the control panel.



The symbol above appears in the “Operating notifications” submenu on the instrument cluster display screen. The LED in button (7) lights up. In addition, the roof hatches close automatically.



#### Note:

Use this function when driving through a tunnel, for example. “Smog” mode is limited to a period of approximately 10 minutes. It is possible to switch the driver’s area back to fresh-air mode separately using switch (1); smog mode remains in effect in the passenger compartment. Switch it off by pressing button (7) (LED off) again.

## Activating the reheat function

### Activating the reheat function

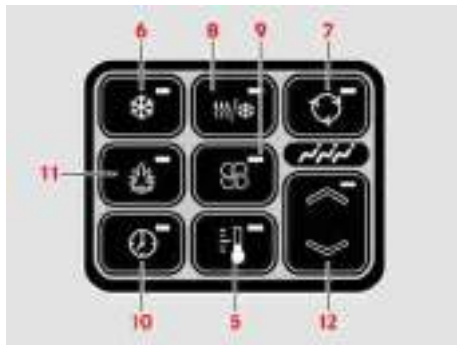

M83\_00-0117-01

- ▶ Press button (8) on the control panel.

### **i** Note:

The recirculated air (i.e. the reduced amount of fresh air) is cooled as it comes into contact with the refrigerant heat exchanger and reheated by the heat exchanger for the heating system. This process condenses water out of the air passed through the system. The air directed to passengers or the driver is thereby dehumidified.

The LED integrated in the pushbutton lights up and the roof hatches close automatically.

### **i** Note:

Reheat mode is available only if the outside temperature is above approximately 12 °C, and it is limited to a period of approximately 30 minutes. To switch it off, press the reheat button again (LED off).



If this symbol appears on the display screen, current temperature conditions are preventing activation of reheat mode.



If this symbol appears on the display screen, there is no air-conditioning system available and reheat mode cannot therefore be activated.

### Activating the auxiliary heating unit

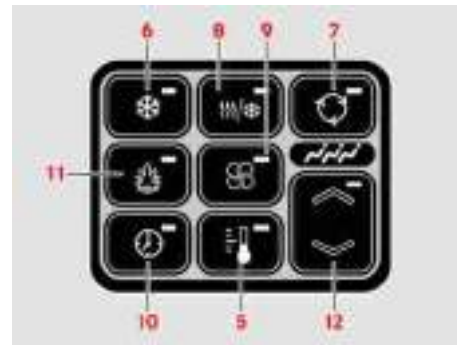

M83\_00-0117-01

- ▶ Press button (11) on the control panel.

### **!** Danger.

Risk of fire and burns. There is a risk of fires and burns due to the high exhaust temperatures and the hot exhaust pipe for the auxiliary heating. For this reason, do not stop or park the bus over ignitable materials (e.g. grass) when the auxiliary heating is in operation, has recently been in operation or has been operated by the instant heating button/preset timer.

## Activating the auxiliary heating unit



### Danger.

Risk of poisoning and asphyxiation. The auxiliary heating must not be used in enclosed spaces such as garages or workshops due to the risk of poisoning and asphyxiation. Timer and preselection mode are similarly prohibited.

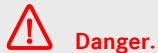

### Danger.

Risk of fire. The auxiliary heating must remain switched off in places where ignitable vapours or dust can accumulate (e.g. in the vicinity of filling stations, fuel depots, or coal, sawdust or grain stores or similar).



### Note:

The integrated LED indicates when the auxiliary heating unit is ready for operation (in standby). The auxiliary heating unit cannot be switched to standby mode unless automatic control has been enabled.



### Note:

The auxiliary heating unit switches to a state of readiness only if the outside temperature is at least 6 °C below the set-point value selected (passenger compartment).



### Note:

With the ignition starter switch OFF, it is possible to switch the auxiliary heating unit on directly by pressing button (11) on the control panel. The LED in button (11) lights up and the auxiliary heating is activated. The auxiliary heating unit switches off automatically after 30 minutes or if the button is pressed again; the LED in button (11) goes out.



Whenever the auxiliary heating unit is active (ignition starter switch position "ON"), the symbol above appears on the display screen after a delay

of approximately 20 seconds. The status in effect at the time the ignition starter switch is switched to OFF is retained when the ignition is switched back on.



If this symbol appears on the display screen, current temperature conditions are preventing activation of heating mode.

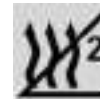

If this symbol appears on the display screen, there is no auxiliary heating unit available.

## Programming auxiliary heating switch-on times

### Programming auxiliary heating switch-on times

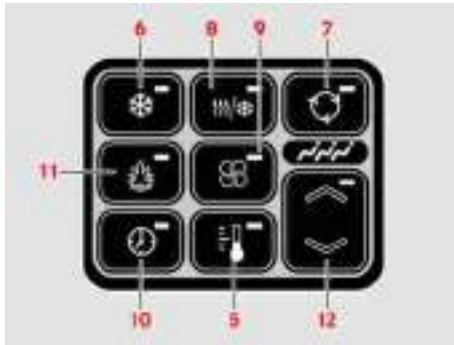

M83\_00-0117-01

- ▶ Keep button (10) pressed down until the preset timer menu is shown on the display screen.



M83.000874-71

Display screen in the preset timer menu (selection mode).

### **i** Note:

In selection mode, rocker switch (12) can be used to select the switch-on duration or timer programs 1 - 3.

### **i** Note:

The driver can close the pop-up window at any time using the "left arrow" button on the steering wheel. In addition, it is necessary to press any button on the HVAC control panel before the "Auswahlmodus" (Selection mode) or "Einstellmodus" (Setting mode) pop-up windows can be reopened.

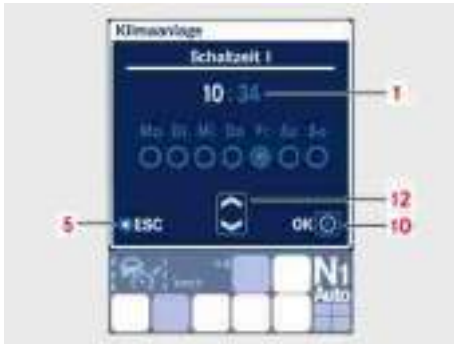

M83.00-0868-71

- ▶ Briefly press button (10) to change to setting mode. The hours (1) can now be set using rocker switch (12). (If it is not necessary to correct the hours, it is possible to move on to change the minutes by pressing button (10).)



M83.00-0869-71

- ▶ The minutes can be adjusted using rocker switch (12). (If it is not necessary to correct the minutes, it is possible to move on to change the weekday by pressing button (10).)

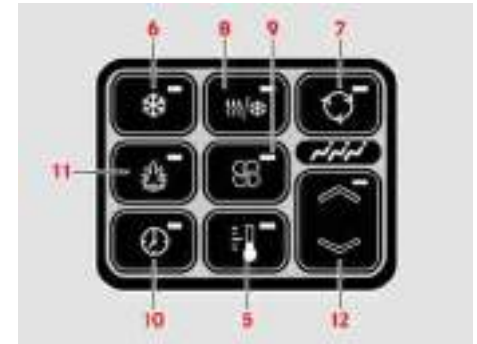

M83\_00-0117-01

- ▶ The relevant weekday is selected using button (10) and set or unset using rocker switch (12).

## Activating a programmed auxiliary heating switch-on time



M83.00-0870-71

Screen display when activating the weekdays.



### Note:

Weekdays shown with a radio button containing a dot (1) have been enabled. An empty radio button (2) indicates a weekday that has yet to be enabled.



M83.00-0872-71

Screen display when saving.



### Note:

The changes are stored when you press button (10) (OK) on reaching the last weekday (Sunday). The display reverts to selection mode automatically and it is now possible to select the next switch-on time (1, 2 or 3) or the switch-on duration.

## Activating a programmed auxiliary heating switch-on time

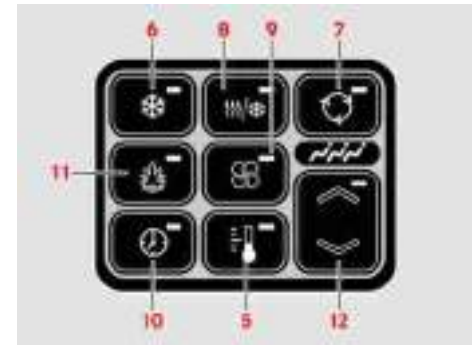

M83\_00-0117-01

- ▶ Press button (10) briefly and select the relevant switch-on program (1, 2 or 3) using rocker switch (12). Confirm the selection by pressing button (10).



## Activating a programmed auxiliary heating switch-on time



### Note:

The LED integrated in button (10) indicates whether a switch-on time has been activated. Steady light for “ignition starter switch ON”. Flashing for “ignition starter switch OFF”.



### Danger.

Risk of poisoning and asphyxiation. The auxiliary heating must not be used in enclosed spaces such as garages or workshops due to the risk of poisoning and asphyxiation. Timer and preselection mode are similarly prohibited.



M83.00-0872-71

Screen display when activating the switch-on times.



### Danger.

Risk of fire and burns. There is a risk of fires and burns due to the high exhaust temperatures and the hot exhaust pipe for the auxiliary heating. For this reason, do not stop or park the bus over ignitable materials (e.g. grass) when the auxiliary heating is in operation, has recently been in operation or has been operated by the instant heating button/preset timer.



### Danger.

Risk of fire. The auxiliary heating must remain switched off in places where ignitable vapours or dust can accumulate (e.g. in the vicinity of filling stations, fuel depots, or coal, sawdust or grain stores or similar).



### Note:

The driver can close the pop-up window at any time using the “left arrow” button on the steering wheel. In addition, it is necessary to press any button on the HVAC control panel before the “Auswahlmodus” (Selection mode) or “Einstellmodus” (Setting mode) pop-up windows can be reopened.

## Deactivating an activated switch-on time

### Deactivating an activated switch-on time

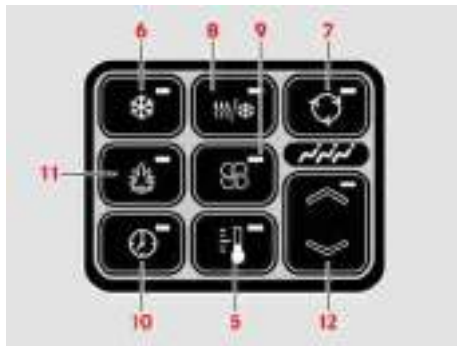

M83\_00-0117-01

- ▶ Press button (10) briefly and select “Aktivierung aus” (Activation off) menu item (1) using rocker switch (12). Confirm the selection by pressing button (10).



#### Note:

The LED in button (10) goes out. No deactivation is possible unless the ignition starter switch is ON.



M83.00-0873-71

Screen display when deactivating the switch-on times.



#### Note:

The driver can close the pop-up window at any time using the “left arrow” button on the steering wheel. In addition, it is necessary to press any button on the HVAC control panel before the “Auswahlmodus” (Selection mode) or “Einstellmodus” (Setting mode) pop-up windows can be reopened.

### Programming the auxiliary heating switch-on duration

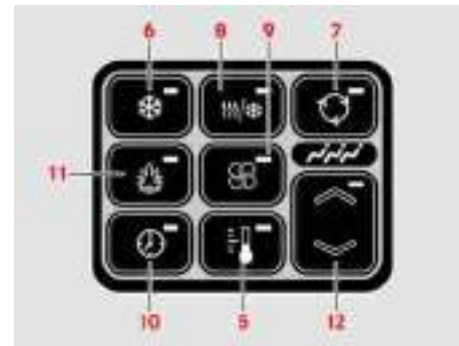

M83\_00-0117-01

- ▶ Keep button (10) pressed until the preset timer menu (selection menu) is shown on the display screen.

## Programming the auxiliary heating switch-on duration



M83.000874-71

- ▶ Press rocker switch (12) (+ or -) repeatedly until switch-on duration (1) on the display screen is selected. Briefly press button (10) to change to setting mode. Rocker switch (12) can now be used to adjust the switch-on duration in the 10-120 minutes range. Confirm the change by pressing button (10).

### **i** Note:

If rocker switch (12) is pressed and held, the switch-on duration is adjusted in increments of 10.

### **i** Note:

The auxiliary heater switch-on duration is programmed once and then applies to all three switch-on times.

### **i** Note:

Recommended switch-on duration: 30 - 40 minutes. A longer switch-on duration could discharge the vehicle batteries.



M83.00-0875-71

Screen display when setting the switch-on duration for the auxiliary heater

### **i** Note:

The driver can close the pop-up window at any time using the "left arrow" button on the steering wheel. In addition, it is necessary to press any button on the HVAC control panel before the "Auswahlmodus" (Selection mode) or "Einstellmodus" (Setting mode) pop-up windows can be reopened.

## Switches/controllers in the driver's rest area

Switches/controllers in the driver's rest area

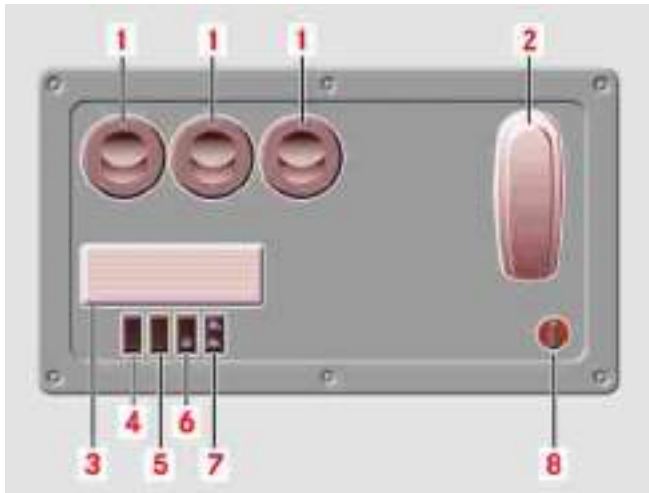

### Air-conditioning switch (6) (option)



This switch enables air conditioning in the driver's rest area.

**i** **Note:**

The function is possible only if the air conditioning in the passenger compartment has been activated.

**i** **Note:**

Maximum air-conditioning output is achieved when controller (8) is turned fully anti-clockwise.

### Switch for ventilation blower speed I and II (7)



When the switch is pressed, the blower for ventilating the driver's rest area operates at half speed or full speed, depending on the switch position.

**i** **Note:**

The air from vents (1) may be hot or cold. This depends on the position of controller (8) and switch position (6).

### Heating controller (8)

Manual, infinitely variable adjustment of the outlet temperature.

**i** **Note:**

Warm: Turn the controller clockwise.

**i** **Note:**

Cold: Turn the controller anti-clockwise.

**i** **Note:**

The engine or the auxiliary heating unit must be running.



|  |     |
|--|-----|
| Door pushbuttons in the driver's area .....  | 300 |
| Anti-entrapment protection (reversing) in the door closing direction .....                                 | 301 |
| Protection against entrapment in the door opening direction .....  | 301 |
| Operating/malfunction displays: doors .....  | 301 |
| Unlocking the door circuit at the front right door .....   | 304 |
| Unlocking the door circuit by key remote (option) .....  | 305 |
| Unlocking the luggage compartment flaps using the pushbuttons in the driver's area .....                   | 305 |
| Locking door 1 .....   | 306 |
| Locking (by key remote) .....  | 307 |
| Emergency operation (depressurising the doors using the emergency valves) .....                            | 309 |
| Emergency unlocking of the luggage compartment flaps in the event of a compressed-air supply failure ..... | 311 |
| Emergency exit through emergency operation of the roof hatches .....                                       | 312 |

### Door pushbuttons in the driver's area

#### Door pushbuttons in the driver's area

Door pushbuttons for front right door (1) and centre right door (2) with integrated warning lamp and emergency valve reset pushbutton (3) (locator lighting also ON when Lights ON).



#### Note:

The warning lamp lights up when: - a door is open - a door is not fully closed (door not latched).



#### Note:

The warning lamp flashes in the event of - operating pressure too low (depressurised bus door) - door malfunction.



#### Danger.

If the display flashes, correct operation of the doors is no longer guaranteed. Do not move the bus if a warning lamp in the door pushbutton lights up or a yellow or red alert is shown on the display screen. If you attempt to do so, a red alert will appear on the display screen and the warning buzzer will sound.



#### Note:

A door cannot be operated unless the ignition starter switch is ON, the bus is stationary and the doors have been unlocked.



#### Note:

After an emergency valve has been operated, the door system cannot be restored to normal operation until emergency valve reset pushbutton (3) has been pressed.



M68.00-0578-71



## Anti-entrapment protection (reversing) in the door closing direction

## Anti-entrapment protection (reversing) in the door closing direction

The anti-entrapment protection is activated if a person or object blocks the door leaf while the door is closing.

The door valve switches to “Open”.

## Protection against entrapment in the door opening direction

Opening pressure is limited to 4.2 bar when the doors are being opened. This ensures that the door opens with a force no higher than the statutory limit.

**Danger.**

If an object or a person becomes trapped during the opening procedure, it is possible to switch the door valve back to closing mode by pressing the door push-button again. The door system can also be depressurised and thus switched to reduced-power pushback by the use of the emergency valve.

## Operating/malfunction displays: doors

## Doors and flaps



M26.00-0182-71

Closed doors, flaps and ramps are greyed out, while opened ones appear in white. An open access point is additionally indicated by an operating display in the lower permanent display field. (If the parking brake is applied, the wheel on the driven axle appears in white.)

#### Yellow/red door alert



M54.00-1988-71

In the event of a door malfunction, a yellow or red alert is displayed, depending on the severity of the malfunction. As soon as the alert has been acknowledged, the bus view appears and the door concerned is highlighted yellow or red.

#### Emergency valve operated



M54.00-1989-71

If an emergency valve has been operated (door depressurised), an “Emergency valve operated” red alert is issued. The driver can acknowledge the red alert using the steering wheel buttons only while the bus is stationary. A yellow alert then appears for the malfunctioning door. As soon as the yellow alert has been acknowledged, the bus view appears and the door concerned is highlighted red. In addition, a red emergency valve symbol is displayed below the door.



#### Note:

A warning signal sounds.



#### Note:

Display shown when an interior or exterior emergency valve is operated at the front right or centre right door.



#### Note:

After an emergency valve has been operated, the door system cannot be restored to normal operation until the emergency valve reset pushbutton (on the instrument panel, next to door pushbutton) has been pressed.

#### Door malfunction warning - door I (front right) or door II (centre right)



A malfunction is present in the door system if this icon appears on the display

screen while the bus is in motion or stationary. At the same time, a RED warning level malfunction message is displayed, the warning lamp in the door pushbutton flashes and the warning buzzer sounds.

**Danger.**

Stop the bus immediately (traffic conditions permitting). It is prohibited to move the bus at any time while this malfunction is present. Have an OMNIplus Service Partner check the door system immediately.

**Danger.**

This display also appears if the compressed-air supply in the door system is too low. Start the bus and charge the compressed-air supply. If the display still does not go out, have the door system checked by an OMNIplus Service Partner.

**Danger.**

This icon also appears in the display if the bus is moving faster than 3 km/h and door I (front right) or door II (centre right) is open.

**Note:**

Symbol is an example for door I (front right door).

**Ready to depart**

This icon appears in connection with the bus stop brake or drive-off lock.

**Note:**

If the bus is equipped with a bus stop brake (option), this icon appears when the bus stop brake pushbutton is pressed.

**Note:**

If the bus is equipped with a drive-off lock, this icon will appear when the doors are completely closed following a closing procedure.

**Note:**

The bus stop brake and the drive-off lock are applied on all axles with reduced braking pressure and are released as soon as the accelerator pedal is depressed.

### Unlocking the door circuit at the front right door



#### **Danger.**

The bus may roll away if the parking brake has not been applied.

### Unlocking the door circuit at the front right door



#### **Danger.**

All doors must be unlocked before the bus is driven off.

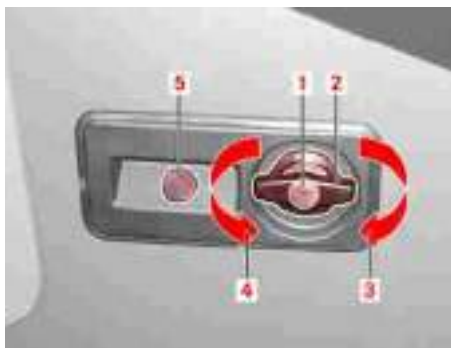

M72\_00-0244-01

- ▶ To unlock the doors, insert the key into lock (1), turn it clockwise and turn handle (2) to the right at the same time (arrow position 3). Turn the key and handle (2) back to their initial position and remove the key. Press exterior pushbutton (5).



#### **Note:**

The fuel filler flaps are unlocked at the same time as the doors.



#### **Note:**

If the bus is equipped with an anti-theft alarm system, this will not be disarmed. Switch on the ignition within 30 seconds.

Door 1 opens automatically.



#### **Note:**

As an option, two exterior pushbuttons may be fitted. Door 2 opens when the pushbutton on the left is pressed.

## Unlocking the door circuit by key remote (option)

## Unlocking the door circuit by key remote (option)

**Danger.**

All doors must be unlocked before the bus is driven off.



M82.00-0140-71

- ▶ Unlock the door circuit (door I, door II, external emergency release handles on the roof hatches and fuel filler flaps) by pressing button (2).

Unlocking of the door circuit is indicated by one short flash of the turn signals.

**Note:**

If button (2) on the key is pressed twice in quick succession, the luggage compartment flaps will also be unlocked.

**Note:**

If a door or luggage compartment flap is not opened within one minute, the circuit will relock automatically. This prevents the bus from remaining unlocked if it was unlocked by accident. If the luggage compartment flaps are still unlocked approximately 43 minutes after the ignition was switched to OFF, forced locking will be initiated to conserve battery charge. If the bus is equipped with an optional anti-theft alarm system, the ignition must be switched on within 30 seconds of the door being opened and unlocked, otherwise the alarm will be triggered.

## Unlocking the luggage compartment flaps using the pushbuttons in the driver's area



M54.00-1900-71

- ▶ Unlock the left-side luggage compartment flaps using pushbutton (1) and the right-side flaps using pushbutton (2).

**Note:**

It is possible to unlock the fuel filler flaps by pressing and holding both pushbuttons simultaneously for longer than 5 seconds.

The left- or right-side luggage compartment flaps can be opened. The

### Locking door 1

LEDs in pushbuttons (1) and (2) light up when the luggage compartment flaps are unlocked.

#### **i** Note:

There must be sufficient compressed air available.

#### **i** Note:

The luggage compartment flaps are relocked when the pushbuttons in the driver's area are pressed again.

#### **i** Note:

The luggage compartment lighting switches on automatically if at least one luggage compartment flap (left or right) is opened.

#### Locking door 1

- ▶ Close door 1

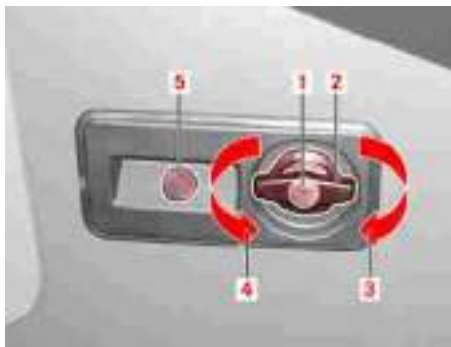

M72\_00-0244-01

- ▶ To lock the front right door, insert the key into lock (1), turn it clockwise and turn handle (2) to the left (arrow position 4). Turn the key and handle (2) back to their initial position and remove the key.

#### **i** Note:

With the ignition switched off, the doors will be locked if both are closed. At the same time, the fuel filler flaps, all luggage compartment flaps and the exterior emergency release handles of the roof hatches are locked.

#### **i** Note:

The turn signals do not give feedback (by flashing three times) unless the complete bus has been closed. This means: All doors, flaps and roof hatches closed and locked. Driver's window closed.

## Locking (by key remote)



M82.00-0140-71

- ▶ Pressing button 1 initiates central locking, i.e. the door circuits and the luggage compartment flap circuits are locked automatically.

**Note:**

The turn signals flash briefly 3 times (approximately 1 second) to confirm that the bus is locked.

**Note:**

The driver's window and service covers are neither closed nor locked automatically; these have to be closed or locked manually.

**Note:**

A buzzer will sound for 10 seconds if an attempt is made to lock the bus even though the bus doors, luggage compartment flaps or driver's window have not been closed and locked. The anti-theft alarm system is not primed (red LED in the driver's area does not flash).

**Note:**

The luggage compartment flaps can also be locked or unlocked by two pushbuttons in the driver's area when the ignition is switched on.

**Note:**

If the luggage compartment flaps are closed but still unlocked 43 minutes after the ignition was switched to OFF, forced locking will be initiated to conserve battery charge.

### Locking (by key remote)



M54.00-1901-71



#### Note:

Always carry out a pre-drive visual check to ensure that all exterior flaps and covers are properly closed.



#### Note:

If a luggage compartment flap has not been closed correctly, the bus graphic shows which luggage compartment flap is open.

- ▶ Optional, automatic priming of the anti-theft alarm system (ATA)



#### Note:

As soon as the bus is locked, the optionally installed anti-theft alarm system is primed automatically (the ATA red LED in the driver's area flashes).



#### Note:

A buzzer will sound for 10 seconds if an attempt is made to prime the anti-theft alarm system even though the bus doors, luggage compartment flaps or driver's window have not been closed and locked. The anti-theft alarm system is not primed (red LED in the driver's area does not flash).



#### Note:

The driver's window and service covers are neither closed nor locked automatically; these have to be closed or locked manually before the anti-theft alarm system can be primed.



#### Note:

It is possible to stay inside the bus even with the central locking system locked. The ignition has to be switched on before the bus is locked with the remote control (button 1). Once the bus has been locked, the anti-theft alarm system is primed but interior motion detection remains deactivated. It is now possible to switch the ignition starter switch to the OFF position. Interior motion detection will remain deactivated until the next time the bus is unlocked and then locked. It is not necessary to switch the ignition starter switch to ON to reactivate interior motion detection in this case.



## Emergency operation (depressurising the doors using the emergency valves)

## Emergency operation (depressurising the doors using the emergency valves)

**Danger.**

The doors must remain centrally unlocked when the bus is in motion.

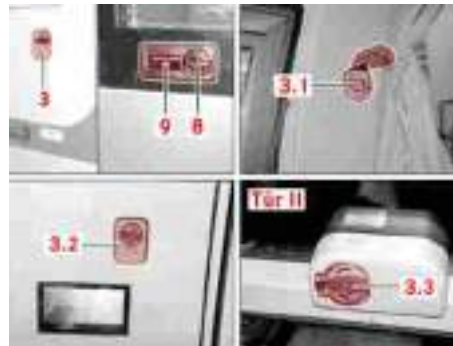

M72\_00-0023-01

**Note:**

3 Exterior emergency valve, front right door

**Note:**

3.1 Interior emergency valve, front right door

**Note:**

3.2 Exterior emergency valve, centre right door

**Note:**

3.3 Interior emergency valve, centre right door

- ▶ Turn interior emergency valve (3.1/3.3) or exterior emergency valve (3/3.2) in the direction of the arrow.

**Note:**

When the emergency valve is operated, the door valve is vented of air. At the same time, the emergency valve also releases the air in the door system. The door system is now depressurised and it must now be possible to move the door manually.

### Emergency operation (depressurising the doors using the emergency valves)

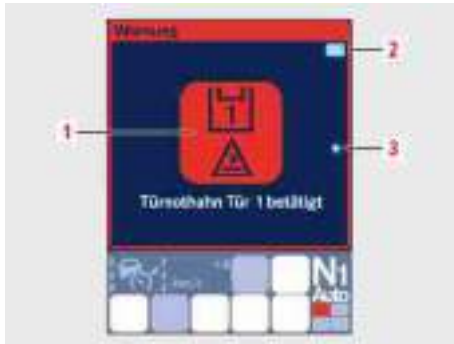

M54.00-2002-71

The warning buzzer sounds in the driver's area. The red warning lamp in the relevant door pushbutton must flash. If an emergency valve has been operated (door depressurised), a red alert (1) is displayed. The red alert displays this icon (1.1) and the message "Tür 1 bzw. Tür 2 Nothahn betätigt" (Door 1/2 emergency valve operated). At the same time, the red parking brake indicator lamp lights up in the instrument cluster.

**i Note:**

The driver is able to acknowledge red alerts using the "OK" button on the steering wheel but not until the vehicle has been brought to a halt and the parking brake has been applied.



M54.00-1989-71

As soon as the red alert has been acknowledged, the bus view appears and the door concerned is highlighted red. In addition, a red emergency valve symbol is displayed below the corresponding door.

- ▶ Restoring operation of the door system: Press the emergency valve reset pushbutton (on instrument panel, next to door pushbutton). Then close the door using the door pushbutton



**Danger.**

Risk of injury. Make sure that nobody is within the sweep of the door leaf when operation of the door system is restored. Doors must not move with a jerky or jolting action after normal operation has been restored.

- ▶ Provide the emergency valve with a new tamper-evident seal.



A tamper-evident seal is not permitted on buses delivered to France.

## Emergency unlocking of the luggage compartment flaps in the event of a compressed-air supply failure

## Emergency unlocking of the luggage compartment flaps in the event of a compressed-air supply failure

**i** Note:

If there has been a complete failure of the central compressed-air supply and the electrical power supply, the luggage compartment flaps can be emergency-unlocked by means of an emergency operating facility (compressed-air supply for spare wheel).



M00\_00-0575-71

- ▶ Open the front cover of the bus using lever (1) in the front right doorway
- ▶ Remove the spare wheel

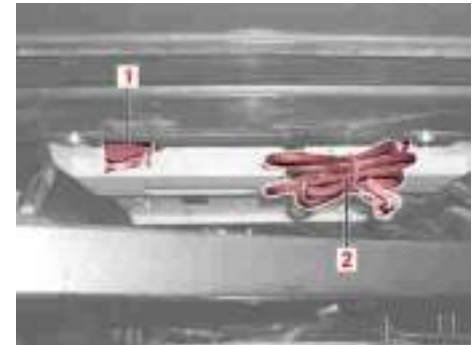

M40\_00-0073-01

- ▶ Take the hose with tyre connection (2) from the plate behind the heating front cabinet and connect it to the tyre inflation valve on the spare wheel.

**i** Note:

The spare wheel has a pressure of approximately 8 bar. The compressed air in the spare wheel passes through shuttle valves to the cylinders of the luggage compartment locking system and unlocks the luggage compartment flaps. The luggage compartment flaps can then be opened.

### Emergency exit through emergency operation of the roof hatches



#### Note:

Reinflate the spare wheel to the specified pressure as soon as possible.

### Emergency exit through emergency operation of the roof hatches



#### Danger.

The emergency release is only for use in an emergency and when the bus is stationary.



#### Note:

Both emergency exits (front and rear roof hatches) are unlocked as soon as the bus is unlocked by the central locking system, the lock at door 1 is unlocked or whenever the ignition starter switch is switched to ON. They are relocked as soon as the ignition starter switch is switched to OFF and the bus is locked by the central locking system or the lock at door 1 is locked.



M77\_00-0017-01

- ▶ Remove cover (1) by pulling on handle (2) (Velcro fastener) to gain access to the emergency exit roof hatch.

## Emergency exit through emergency operation of the roof hatches



M77\_00-0016-01

- ▶ Emergency operation is initiated by means of a red exterior or interior twist handle (1).

**Note:**

In emergencies, interior twist handle (1) must be turned in the direction of the arrow (clockwise). The emergency exit cover (2) can now be secured by a safety rope and placed to one side outside the bus.

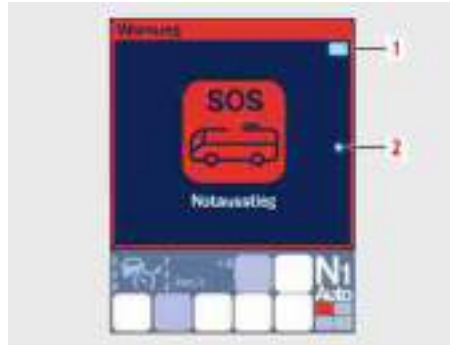

M54.00-1990-71

A red alert is displayed on the display screen in the event of emergency operation or if an exterior handle on one of the emergency exit roof hatches is in locked condition with the ignition starter switch switched to ON. The red alert displays this icon and the message “SOS Notausstieg” (SOS Emergency exit).

**Note:**

The driver is able to acknowledge red alerts using the “OK” button on the steering wheel, but not until the vehicle has been brought to a halt and the parking brake has been applied.

**Danger.**

Following emergency operation of an emergency exit roof hatch, it is necessary to have the cover fitted by specialist personnel at an OMNIplus Service Partner.



|   |            |
|---|------------|
| <b>Safety precautions/general information</b> .....             | <b>317</b> |
| <b>Use for the intended purpose</b> .....                       | <b>318</b> |
| <b>Approved personnel</b> .....                                 | <b>318</b> |
| <b>First use of the kitchenette</b> .....                       | <b>318</b> |
| <b>Switching on the galley</b> .....                            | <b>319</b> |
| <b>Filling the fresh water tank inside the bus</b> .....        | <b>321</b> |
| <b>Filling the fresh water tank outside the bus</b> .....       | <b>322</b> |
| <b>Checking and cleaning the fresh water filter</b> .....       | <b>322</b> |
| <b>Drawing water from the water tap</b> .....                   | <b>323</b> |
| <b>Switching on the sausage heater</b> .....                    | <b>323</b> |
| <b>Cleaning the sausage heater</b> .....                        | <b>326</b> |
| <b>Descaling the sausage heater</b> .....                       | <b>326</b> |
| <b>Switching on the coffee machine</b> .....                    | <b>327</b> |
| <b>Brewing 1/2 a carafe of coffee (10 cups of coffee)</b> ..... | <b>327</b> |
| <b>Brewing 1 carafe of coffee (20 cups of coffee)</b> .....     | <b>328</b> |
| <b>Descaling the coffee machine</b> .....                       | <b>329</b> |

### Table of contents

|   |            |
|---|------------|
| <b>Dispensing cups of hot water (alternative to coffee machine)</b> ..... | <b>330</b> |
| <b>Boiler (option)</b> .....  | <b>331</b> |
| <b>Setting the thermostat of the water heater</b> .....                   | <b>332</b> |
| <b>Descaling the water heater boiler</b> .....                            | <b>333</b> |
| <b>Winter operation</b> .....   | <b>334</b> |
| <b>Draining the fresh water tank</b> .....                                | <b>335</b> |
| <b>Draining the water lines</b> .....                                     | <b>335</b> |
| <b>Draining the boiler</b> .....  | <b>336</b> |
| <b>Draining the siphon</b> .....  | <b>337</b> |
| <b>Replacing fuses</b> .....  | <b>337</b> |
| <b>Malfunctions</b> .....   | <b>340</b> |
| <b>Using the sausage heater again after a malfunction</b> .....           | <b>340</b> |
| <b>Using the coffee machine again after a malfunction</b> .....           | <b>341</b> |
| <b>Using the boiler (option) again after a malfunction</b> .....          | <b>342</b> |
| <b>Other malfunctions</b> .....   | <b>343</b> |
| <b>Switching off the galley</b> .....                                     | <b>344</b> |



### Safety precautions/general information



#### Caution:

Never operate the equipment without water. Risk of thermal damage - loss of warranty.



#### Caution:

Do not use the coffee machine or sausage heater unless the kitchenette is open. Damage caused by heat and steam when the kitchenette is closed is not covered by the warranty.



#### Danger.

To avoid the risk of fire and damage, it is prohibited to store anything inside the sausage heater or microwave oven.



#### Danger.

Secure loose objects in the kitchenette (cans, cups, lids, etc.) properly during the journey.



#### Danger.

Use only clean drinking water.



#### Danger.

To prevent the growth of microbes in water left inside the system, the entire system must be drained (refer to "Winter operation") if the kitchenette and/or lavatory is to remain out of service temporarily.



#### Note:

It is advisable to disinfect water-carrying systems at regular intervals or after operation has been restored. A sodium hypochloride solution (from camping and caravanning retailers) is particularly suitable; observe the manufacturer's instructions.



#### Note:

Waste water from the kitchenette flows into the lavatory's holding tank.



#### Environmental protection

Dispose of waste in an environmentally responsible manner. The rules and regulations of the country in which the vehicle is operated must be observed.

### Use for the intended purpose

#### Use for the intended purpose

The kitchenette and its equipment are intended for normal kitchen use during a bus journey. This includes:

- Sausage heater for preparing sausages
- Coffee machine for brewing coffee
- Boiler (option) for dispensing cups of hot water

Any other use cannot be considered use for the intended purpose.

#### Approved personnel

The galley may only be used by trained personnel. The personnel must be professionally qualified and have read and understood this section.

The safety of the person using the kitchenette and the security of all kitchen utensils are prerequisites for use of the kitchenette while the bus is in motion.



**Danger.**

Objects being thrown out of the kitchenette can cause injuries. The person using the kitchenette must secure loose objects safely while the bus is in motion.

#### First use of the kitchenette

- ▶ Kitchenette switched on
- ▶ Fresh water tank filled and connected
- ▶ All packaging materials must be removed before the kitchenette is used for the first time.



#### Environmental protection

Dispose of the packaging material in an environmentally responsible manner.

- ▶ Before first use, clean the sausage heater tank, the lid and the overflow pipe thoroughly with hot water and a commercially available washing-up liquid, and then rinse well with clean water. Then wipe the sausage heater tank dry to avoid scaling.
- ▶ To clean the coffee machine, fill it with water and brew the water without coffee powder but with the filter fitted, then repeat.

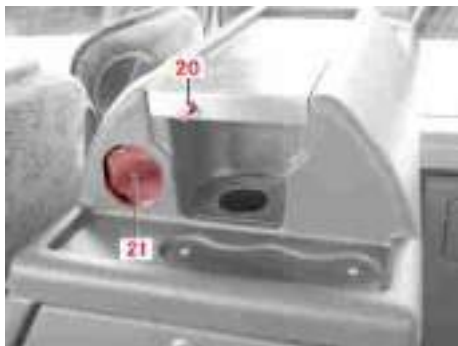

M86\_00-0178-71

- ▶ Before the boiler (option) is switched on, its tank must be filled with water.

### **i** Note:

Switch on the boiler using the kitchenette master switch on the instrument panel. Do not start the engine, otherwise the boiler will begin to heat. Press and hold hot water dispensing button (20) until water flows out of the dispenser with no air (it takes approximately 2 minutes for the boiler to fill). It is advisable to flush the boiler with fresh water. To do this, draw approximately 2 to 3 litres of hot water. Start the engine to heat the boiler

(length of the heating phase approximately 5 minutes).

### **i** Note:

Fill cup dispenser (21) from the front with cups, approximately 100 cups.

The kitchenette is ready for use.

### Switching on the galley

#### **i** Note:

The coffee machine, sausage heater and boiler (option) cannot be operated unless the engine is running.



M54.00-1931-71

- ▶ Press galley master switch (1).

A buzzer sounds in the galley electronics. The LED in master switch (18) lights up.

### Switching on the galley

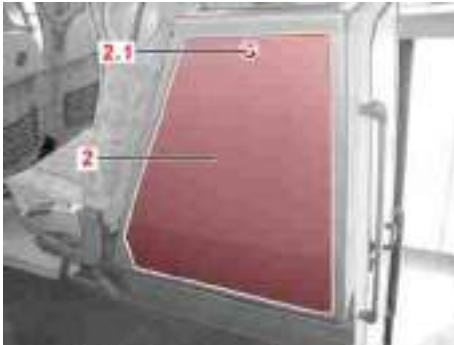

M86\_00-0169-71

- ▶ Release cover (2) on lock (2.1) by unlocking and removing it.



#### Note:

Stow the galley cover safely.



M86\_00-0170-71

- ▶ Switch on the galley lighting using button (3) on the galley control panel.

The galley lighting on the left above the washbasin comes on. The LED in button (3) on the control panel lights up.

The galley is open and ready for use.



#### Note:

If battery (1) does not light up in green on the control panel, there is insufficient on-board voltage to operate the kitchenette. Start the engine to enable the batteries to recharge.

## Filling the fresh water tank inside the bus

### Filling the fresh water tank inside the bus

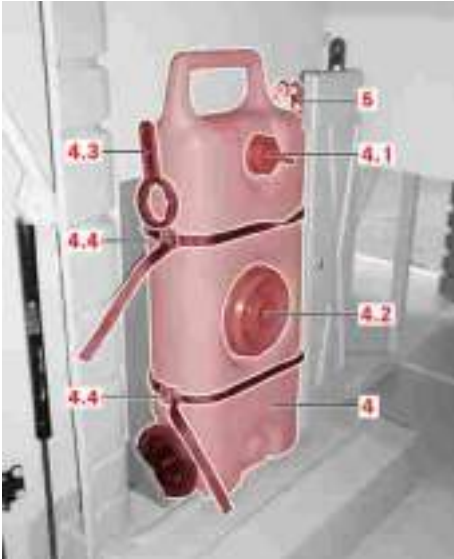

M86\_00-0142-02

- Fill fresh water tank (4) via cap (4.1).

### **Danger.**

The kitchenette must be operated using clean and potable water only. Fresh water for kitchenette requirements must be renewed every day. If the fresh water is stored in the water tank for a long period of time, an additive (Micropur, mat. no. 0.971.407.000) in accordance with the manufacturer's instructions must be mixed with it.

### **Danger.**

The tools used to fill with water (containers, funnels, hoses, etc.) must be sterile.

### **Note:**

It is recommended that fresh water tank (4) be cleaned manually via caps (4.1) and (4.2) and/or that it be flushed thoroughly with fresh water. The fresh water lines should then also be flushed with fresh water by drawing cold/hot water and switching on the coffee machine.

### **Note:**

Use spanner (4.3) if the caps are difficult to turn.

### **Note:**

In new buses, the drinking water may sometimes taste of plastic. An additive (Kunststoff-Frisch, mat. no. 0.971.405.000) can be mixed in accordance with the manufacturer's instructions to neutralise this aftertaste.

### **Note:**

Waste water from the kitchenette flows into the lavatory's holding tank.

### Filling the fresh water tank outside the bus

#### Filling the fresh water tank outside the bus

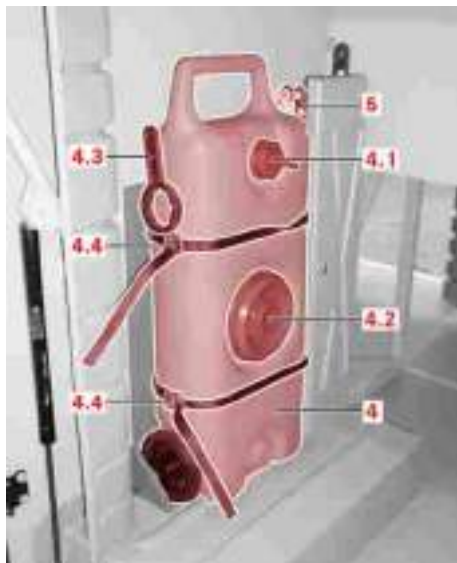

M86\_00-0142-02

- ▶ Disconnect quick-release coupling (5) from fresh water tank (4).

- ▶ Release tensioning straps (4.4). Remove fresh water tank (4).
- ▶ Fill fresh water tank (4) with pure drinking water via cap (4.2). Close cap (4.2) firm and tight.
- ▶ Fit fresh water tank (4) into the bus and secure using tensioning straps (4.4).
- ▶ Connect quick-release coupling (5) to fresh water tank (4).

#### Checking and cleaning the fresh water filter

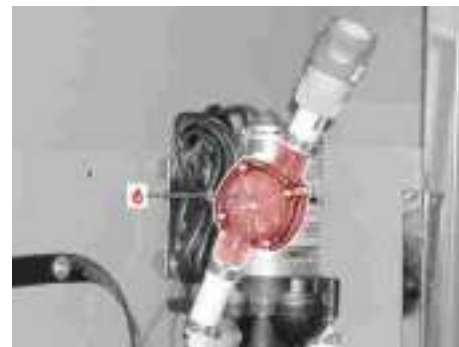

M86\_00-0143-01

- ▶ Check fresh water filter (6) for clogging at regular intervals (depending on the water quality) and clean it if necessary.



#### Note:

The fresh water filter is located between the fresh water tank and the fresh water pump.

### Drawing water from the water tap

#### Drawing water from the water tap

- ▶ Galley switched on
- ▶ Fresh water tank filled and connected



M86\_00-0171-71

- ▶ Press button (7) to draw cold water from tap (8).

Cold water continues to flow while button (7) is pressed.



#### Note:

Tap (8) can be pulled out by approximately 20 cm.

#### Switching on the sausage heater

- ▶ Galley switched on
- ▶ Fresh water tank filled and connected



#### Danger.

There is a risk of scalding when using the sausage heater. Hot steam can rise, which may cause serious burns to the face, arms and hands. Keep at a safe distance, and remove hot sausages using only heat-resistant kitchen utensils.



#### Note:

The heating up time depends on the amount of water, the number of sausages and the temperature of the water used to fill the boiler.

### Switching on the sausage heater



#### Note:

The sausage heater has a capacity of 5 litres.



#### Note:

Waste water from the galley flows into the lavatory's holding tank.



M86\_00-0336-71

- ▶ Insert overflow pipe (1) into the discharge hole, ensuring leak-tightness.



#### Danger.

Never use the sausage heater without water.



#### Note:

Excess water may run out via overflow pipe (1).

- ▶ Fill the sausage heater tank with approximately 4 cm cold or hot water.
- ▶ Add the sausages to the sausage heater tank and replace the lid on the sausage heater tank.



#### Note:

When adding sausages, there is a risk of hot water splashing and causing burns to the face, arms and hands. Add the sausages to the water carefully and keep a safe distance.



## Switching on the sausage heater



M86\_00-0337-71

- ▶ Switch on the sausage heater using button (17) on the control panel.

One of LEDs (17.2) flashes or lights up.

### **i** Note:

Pressing button (17) again switches off the sausage heater. LED (17.2) goes out.

- ▶ Press button (17.1) repeatedly until the desired temperature is set.

### **i** Note:

It is possible to set a temperature of 40, 60, 80 or 95 °C. LED (17.2) indicates the set temperature.

### **i** Note:

LED (17.2) flashes while the sausage heater is heating and lights up when the set temperature has been reached.



M86\_00-0336-71

- ▶ Remove the lid when the sausages are heated.

### **!** Danger.

The sausage heater is hot and generates steam - risk of scalding. Do not remove overflow pipe (1) until the water in the tank has cooled sufficiently that there is no longer a risk of scalding.

- ▶ Take out the sausages using tongs or a suitable, heat-resistant kitchen utensil.

### Cleaning the sausage heater



M86\_00-0336-71

- ▶ The water in the sausage heater tank can be drained as soon as the water has been allowed to cool down. To do this, remove overflow pipe (1) from the discharge hole.

#### Cleaning the sausage heater

- ▶ After use, clean the sausage heater tank, the lid and the overflow pipe with warm water and a commercially available washing up liquid. Use a soft sponge without a scourer or similar abrasive product. Rinse with clean water and wipe the sausage heater tank dry to avoid scaling. Clean the overflow pipe with bottle cleaner at regular intervals.



#### Note:

Clean the sausage heater tank with a commercially available stainless steel cleaner at regular intervals.

#### Descaling the sausage heater

- ▶ Fill the sausage heater tank 2 cm high with descaler.
- ▶ Leave the descaler to work (observe the information issued by the manufacturer).



#### Note:

For heavy scaling, it is possible to operate the sausage heater containing descaler for approximately 30 minutes at 80 °C.

- ▶ Drain the boiler after the descaler reaction time and rinse well with clean water. Wipe the sausage heater tank dry.

### Switching on the coffee machine

#### Switching on the coffee machine

- ▶ Kitchenette switched on
- ▶ Fresh water tank filled and connected



#### Caution:

Running programs cannot be paused. If there is a power failure, it will be necessary to restart the program. If the carafe contains coffee from a previous program, it must be drained first to avoid the risk of overflowing.



#### Caution:

To avoid the risk of overflowing, make sure that the carafe is empty before the brewing process begins.



#### Note:

The coffee filter must equate to size 1 x 6 (commercially available). Add the amount of coffee powder according to taste (e.g. 1 teaspoon per cup).

- ▶ The coffee machine can be used to fill a vacuum carafe with a capacity of 2 litres. This is sufficient to pour 20 100 ml cups of coffee. It is possible to brew 1/2 a carafe or 1 carafe of coffee.

#### Brewing 1/2 a carafe of coffee (10 cups of coffee)



M86\_00-0173-71

- ▶ Remove filter (11) from the filter holder. Insert filter paper and add as much coffee powder as required.



#### Note:

Judge the amount of coffee powder according to taste (e.g. 1 teaspoon per cup).

### Brewing 1 carafe of coffee (20 cups of coffee)

- ▶ Slide filter (11) back into the filter holder.
- ▶ Place an empty carafe (12) under filter (11).



M86\_00-0174-71

- ▶ Press button (13) on the control panel.

The LED in button (13) lights up. The brewing process begins.

- ▶ An electronic signal sounds when brewing has finished.

The LED in button (13) goes out.

### Brewing 1 carafe of coffee (20 cups of coffee)



M86\_00-0173-71

- ▶ Remove filter (11) from the filter holder. Insert filter paper and add as much coffee powder as required.



#### Note:

Judge the amount of coffee powder according to taste (e.g. 1 teaspoon per cup).

- ▶ Slide filter (11) back into the filter holder.
- ▶ Place an empty carafe (12) under filter (11).



M86\_00-0175-71

- ▶ Press button (14) on the control panel.

The LED in button (14) lights up. The brewing process begins.

- ▶ An electronic signal sounds when brewing has finished.

The LED in button (14) goes out.

## Descaling the coffee machine

### Descaling the coffee machine



#### Note:

How frequently the coffee machine should be descaled depends on the water quality but the coffee machine should be descaled immediately if performance deteriorates or if the openings in the spray head (above the filter) begin to scale up.

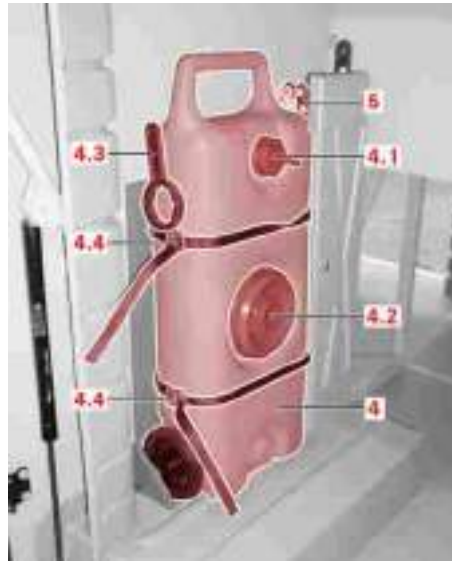

M86\_00-0142-02

- ▶ Disconnect the hose at quick-release coupling (5).

- ▶ Hold the hose in a container of descaler.



#### Note:

Use only descalers that are suitable for domestic appliances. The descaler must not attack plastics and aluminium.

- ▶ Operate the coffee machine with an amount of water sufficient to fill one carafe.
- ▶ Connect the hose to fresh water tank (4).
- ▶ Flush with fresh water. To do this, brew several carafes without coffee.



#### Note:

Repeat the last step until the water no longer tastes or smells of descaler or vinegar.

### Dispensing cups of hot water (alternative to coffee machine)

#### Dispensing cups of hot water (alternative to coffee machine)



#### Note:

The kitchenette is also able to dispense cups of hot water as an alternative if there is no filter (11) in the filter holder. The electronics detect this condition automatically and dispense cups of hot water when the button is pressed.



#### Caution:

There is a risk of scalding when dispensing hot water. There is a possibility of hot steam rising, which could result in severe scalding of the face, arms and hands. Do not dispense hot water unless it is safe to do so.



M86\_00-0173-71

- ▶ Remove filter (11) from the filter holder and remove vacuum carafe (12).



M86\_00-0177-71

- ▶ To ensure stability of the cups, fit cup holder supplied (15) into the filter holder. Place cup dispenser supplied (16) with cups underneath.
- ▶ Remove the cup from cup dispenser (16) and place it in cup holder (15) under the opening of the spray head.



M86\_00-0176-71

- ▶ To dispense hot water into a cup, press button (13) or (14) on the control panel.

One press of button (13) or (14) dispenses one cup of hot water.

### Boiler (option)

- ▶ Kitchenette switched on
- ▶ Fresh water tank filled and connected
- ▶ Boiler filled



#### Caution:

There is a risk of overheating and thermal damage if the boiler is operated with no water. Never operate the boiler without water.

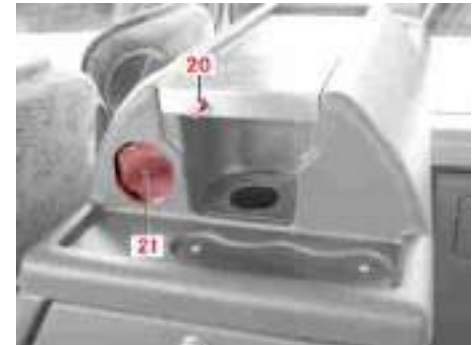

M86\_00-0178-71

- ▶ To make sure that the boiler contains water, press and hold hot water dispensing button (20) before starting the engine until water flows out of the dispenser.

The boiler has been filled with water and bled.

### Setting the thermostat of the water heater

- ▶ The boiler cannot be switched on unless the engine is started first.



#### Note:

The length of the heating phase is approximately 5 minutes.

- ▶ Remove the cup from cup dispenser (21) and place it under the water dispenser.



#### Note:

It is possible to insert approximately 100 cups into the cup dispenser from the front.

- ▶ To dispense hot water into a cup, press hot water dispensing button (20).



#### Caution:

Outflow of hot water - risk of scalding.

Hot water continues to flow while hot water dispensing button (20) is pressed.

### Setting the thermostat of the water heater

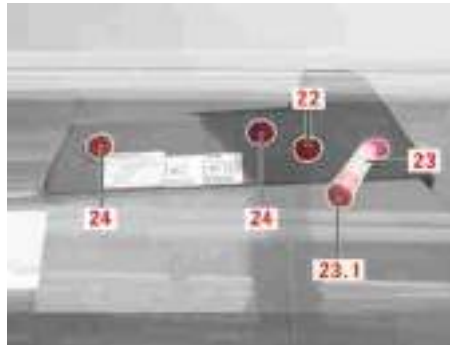

M86\_00-0179-71

- ▶ To set the thermostat, remove cap (22) and turn the thermostat.



#### Note:

The boiler thermostat is located on the back of the water heater.



#### Note:

To set a lower temperature for the boiler, turn the thermostat anti-clockwise.



#### Note:

To set a higher temperature for the boiler, turn the thermostat clockwise.



## Descaling the water heater boiler

### Descaling the water heater boiler

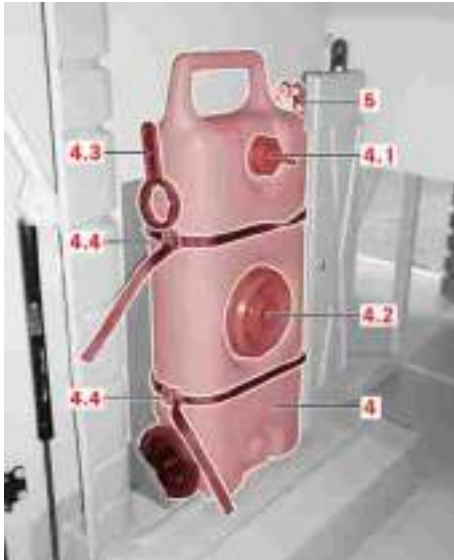

M86\_00-0142-02

- ▶ Disconnect the hose at quick-release coupling (5).

**i** **Note:**

How frequently the boiler should be descaled depends on the water quality but the boiler should be descaled immediately if the heating time is noticeably longer or if the openings in the water dispenser begin to scale up.

- ▶ Hold the hose in a container of descaler (at least 2 litres).

**i** **Note:**

Use only descalers that are suitable for domestic appliances. The descaler must not attack plastics and aluminium. Observe the information provided by the manufacturer.

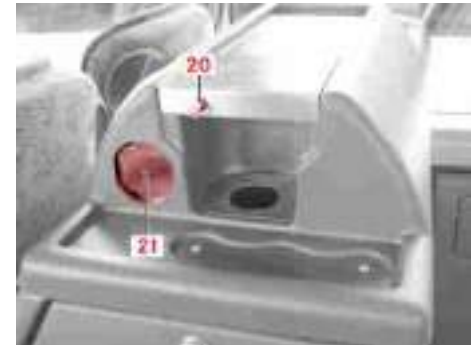

M86\_00-0178-71

- ▶ Place a cup under the water dispenser and press hot water dispensing button (20) until the boiler draws at least 1.5 litres of water.

The boiler is filled with descaler. Observe the manufacturer's instructions on how long to leave the descaler to work.

### Winter operation

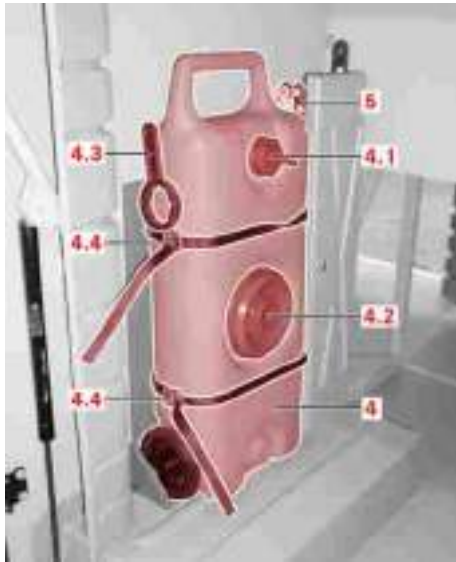

M86\_00-0142-02

- ▶ Connect the hose to fresh water tank (4).

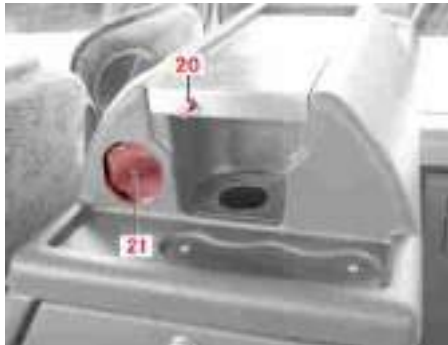

M86\_00-0178-71

- ▶ Flush the boiler with plenty of fresh water. To do this, fill the boiler with fresh water using hot water dispensing button (20) and drain it.

#### **i** Note:

Repeat the last step until the water no longer tastes or smells of descaler or vinegar.

### Winter operation

- ▶ Galley switched on
- ▶ Over winter, drain the fresh water tank, water lines, water heater boiler (option) and siphon.

#### **i** Note:

To prevent damage to water-carrying installations, these must be completely drained before the first frost.

## Draining the fresh water tank

### Draining the fresh water tank

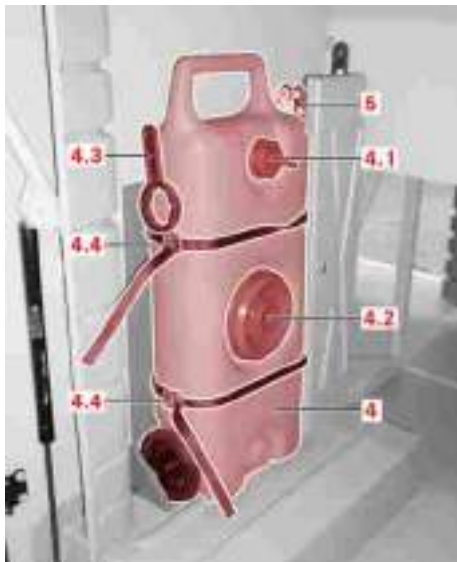

M86\_00-0142-02

- ▶ Disconnect quick-release coupling (5) from fresh water tank (4).

- ▶ Release both tensioning straps (4.4).
- ▶ Remove fresh water tank (4) from the bus and open cap (4.1) to completely drain the water.

### **i** Note:

Use spanner (4.3) if the caps are difficult to turn.

- ▶ Close cap (4.1) firm and tight. Fit fresh water tank (4) into the bus and secure using tensioning straps (4.4). Connect quick-release coupling (5) to fresh water tank (4).

The fresh water tank is completely drained.

### Draining the water lines

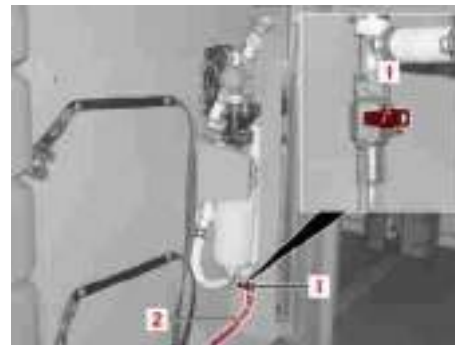

M86\_00-0305-71

- ▶ To drain off the majority of the water, route hose (2) to the outside of the bus and open tap (1).

### **i** Note:

The tap is located in the luggage compartment next to the fresh water tank or below the water pump.

- ▶ To drain off the remaining water, force water through the cold water line using the control panel and run it empty.

### Draining the boiler



M86\_00-0171-71

- ▶ Press and hold button (7) until no more water flows out of tap (8).

The water lines are completely drained.

### Draining the boiler



#### Caution:

There is a risk of overheating if the boiler is operated with no water. Do not start the engine while the boiler is being drained.

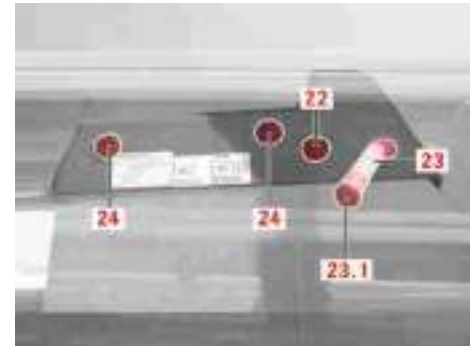

M86\_00-0179-71

- ▶ Pull out winter drain hose (23).



#### Note:

Winter drain hose (23) is located on the back of the boiler.

- ▶ Position a heat-resistant container (minimum capacity of 2 litres) under the end of the hose sealed with a drain plug (23.1).



### Danger.

Hot water may flow out when the boiler is drained. Do not allow your hands or arms to come into contact with the water.

- ▶ Remove drain plug (23.1) and completely drain the water from the boiler into the container underneath.
- ▶ Seal hose (23) with drain plug (23.1) and slide it back.

The boiler is completely drained.

### Draining the siphon



#### Note:

The siphon is located under the washbasin in the lavatory.

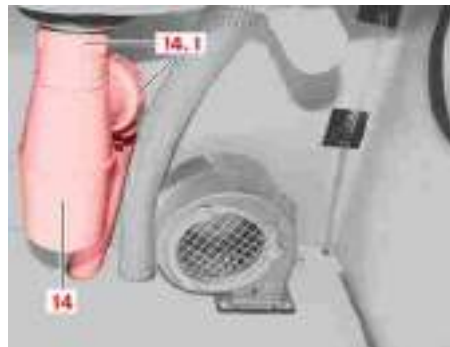

M86\_00-0039-01

- ▶ Dismantle siphon (14) of kitchenette waste water drain at union nuts (14.1) and empty.
- ▶ Fill the siphon with windscreen anti-freeze mat. no. A 001 986 45 71 11 (down to -30 °C) and then reassemble it.

### Replacing fuses



### Danger. Risk of fire.

Do not use fuses with a higher than specified amperage.

The result would be damage to the electrical system or even a fire in the cables.

- Always use fuses of the specified amperage and never attempt to bridge or rewire fuses.
- Fuses should be replaced only when the cause of malfunction has been rectified.



### Danger.

Do not replace fuses unless the power has been switched off.

### Replacing fuses



#### Note:

This description is based on the standard assignment of fuses in the bus. Bus-specific assignment may differ from bus to bus. Not all fuse slots are necessarily occupied in every bus. Furthermore, fuses may occupy unassigned slots because they are protecting special customer options or retrofitted equipment, for example.



M54.00-1931-71

- ▶ Switch off the galley at master switch (1).

The LED goes out.

- ▶ Switch off the engine.



M54.00-2004-71

- ▶ Switch battery isolating switch (01S01) to OFF.

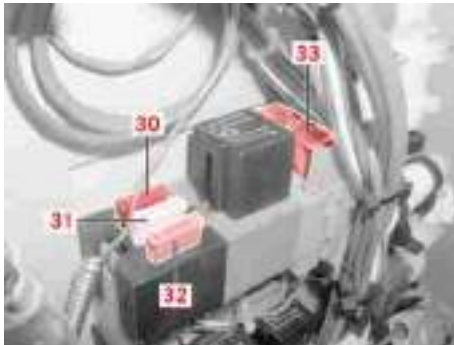

M86\_00-0180-71

- Exchange the defective galley fuse.

**i** **Note:**

The fuses for the galley are located on the back of the galley behind the mirror in the lavatory. The mirror can be removed (screws, mirror bracket or Velcro fasteners).

**i** **Note:**

30 Water pump (10 A)

**i** **Note:**

31 Sausage heater (25 A)

**i** **Note:**

32 Electronics (5 A)

**i** **Note:**

33 Coffee machine (40 A)



M86\_00-0181-71

- Exchange the defective boiler fuse.

**i** **Note:**

The fuses for the boiler are located under the plastic cover. To remove the plastic cover, undo the two screws in the cup recesses and the screw in the carafe recess. Lift the back of the plastic cover approximately 5 cm and slide it forwards to free the plastic cover from the pipe of the cup dispenser.

## Malfunctions



### Note:

34 Terminal 15 (5 A)



### Note:

35 D+ (engine) (5 A)



### Note:

36 Water pump (10 A)



### Note:

37 Boiler (50 A)

## Malfunctions

- ▶ This section describes malfunctions that you can rectify yourself.

## Using the sausage heater again after a malfunction



M86\_00-0337-71

- ▶ The overheating protection is triggered if the sausage heater is operated with no water. The red LED in button (17.3) lights up.



### Note:

Fill the sausage heater with water to rectify the malfunction. Reactivate the overheating protection by pressing button (17.3) on the control panel.



### Using the coffee machine again after a malfunction

#### Using the coffee machine again after a malfunction

- ▶ A continuous tone indicates that the fresh water tank is empty.



#### Note:

Fill the fresh water tank. Press any button on the control panel of the coffee machine. The coffee machine resumes the program from the point at which it was interrupted.



#### Note:

If the kitchenette was switched off at the master switch on the instrument panel, the current program is cleared and it is necessary to restart the coffee machine. Empty the carafe and refill the filter.



M86\_00-0182-71

- ▶ Coffee machine fills with water but does not brew.



#### Note:

To rectify the malfunction, press overheating protection (38). Overheating protection (38) is accessible through an opening (arrowed) in the housing.

- ▶ Overheating protection triggered.



#### Note:

To reactivate the coffee machine, press overheating protection (38). Overheating protection (38) is accessible through an opening (arrowed) in the housing.

### Using the boiler (option) again after a malfunction

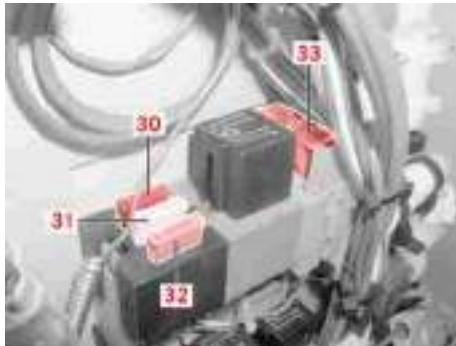

M86\_00-0180-71



**Note:**

Or replace fuse (33).

### Using the boiler (option) again after a malfunction



M86\_00-0181-71

- ▶ The appliance does not dispense water.



**Note:**

Fill the fresh water tank with water. Or replace fuse (36). Or have the water pump exchanged by Customer Service.

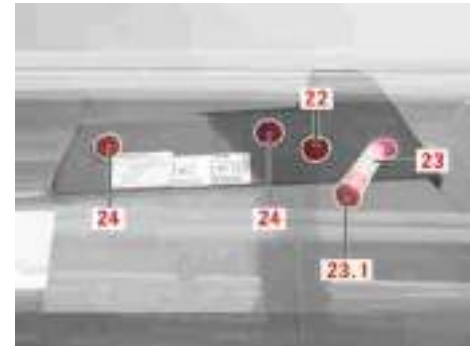

M86\_00-0179-71

- ▶ The overheating protection is triggered if the boiler is operated with no water.



**Note:**

Fill the boiler with water to rectify the malfunction. Press button (24) to reactivate the overheating protection.

### Other malfunctions

- ▶ Temperature of the water too low.



**Note:**

The heating time has not elapsed, it takes approximately 5 minutes.

- ▶ Inadequate flow of hot water.



**Note:**

Symptom of scaling, descale the boiler.

- ▶ Heating time too long.



**Note:**

Symptom of scaling, descale the boiler. Or the overheating protection has been triggered. Reactivate by pressing in button (24).

- ▶ Water flows out of the dispenser when the boiler is heating.



**Note:**

No malfunction, because water expands during the heating process.

#### Other malfunctions

- ▶ The kitchenette does not appear to be working, the battery display remains dark.



**Note:**

The kitchenette undervoltage protection has been triggered. Start the engine and charge the battery to rectify the fault.

### Switching off the galley

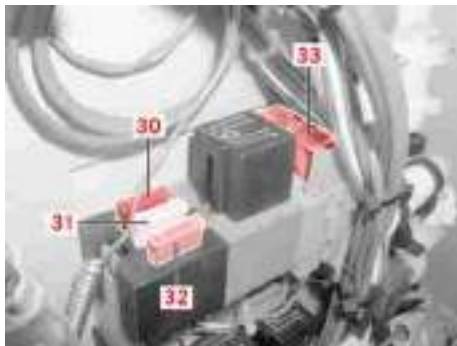

M86\_00-0180-71

- ▶ Galley light does not switch on.

#### **i** Note:

Either change the bulb (24 V/5 W) (prise the left or right-hand lamp out of the kitchenette) or replace fuse (32).

- ▶ No water or irregular flow.

#### **i** Note:

Fill the fresh water tank with water. Check the water supply connection. Check the filter for clogging. Or replace fuse (30). Or have the water pump replaced by the after-sales service.

### Switching off the galley

#### **i** Note:

All appliances must be switched off before the galley can be switched off.



M86\_00-0170-71

- ▶ Switch off the galley lighting using button (3) on the control panel.

The galley lighting LED goes out.

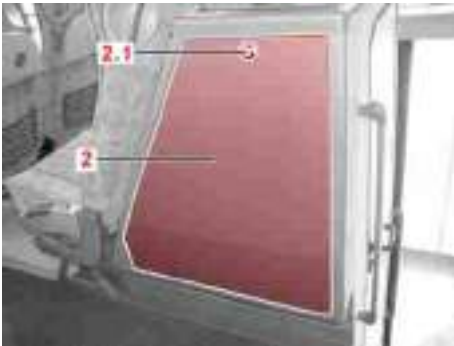

M86\_00-0169-71

- ▶ Fit cover (2) and use lock (2.1) to secure.

The galley is locked away.

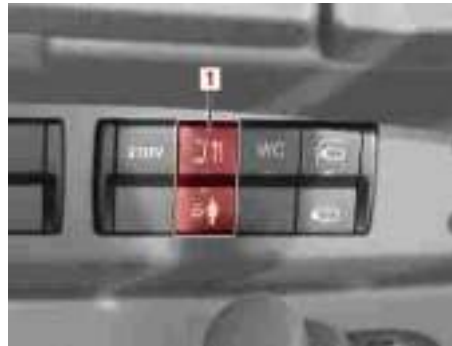

M54.00-1931-71

- ▶ Press galley master switch (1).  
The LED in master switch (1) goes out.  
The galley is switched off.



|   |            |
|---|------------|
| <b>General information</b> .....                          | <b>350</b> |
| <b>Instructions for operating a microwave oven</b> .....  | <b>351</b> |
| <b>Use for the intended purpose</b> .....                 | <b>353</b> |
| <b>Approved personnel</b> .....                           | <b>353</b> |
| <b>First use of the galley</b> .....                      | <b>354</b> |
| <b>Switching on the kitchenette</b> .....                 | <b>355</b> |
| <b>Filling the fresh water tank inside the bus</b> .....  | <b>356</b> |
| <b>Filling the fresh water tank outside the bus</b> ..... | <b>358</b> |
| <b>Checking and cleaning the fresh water filter</b> ..... | <b>358</b> |
| <b>Drawing water from the water tap</b> .....             | <b>359</b> |
| <b>Switching on the boiler</b> .....                      | <b>360</b> |
| <b>Descaling the boiler</b> .....                         | <b>361</b> |
| <b>Switching on the sausage heater</b> .....              | <b>363</b> |
| <b>Cleaning the sausage heater</b> .....                  | <b>366</b> |
| <b>Descaling the sausage heater</b> .....                 | <b>366</b> |
| <b>Switching on the 40-cup coffee machine</b> .....       | <b>367</b> |

### Table of contents

|  |            |
|--|------------|
| <b>Brewing coffee in winter</b> .....                                  | <b>371</b> |
| <b>Cleaning the 40-cup coffee machine</b> .....                        | <b>371</b> |
| <b>Descaling the coffee machine</b> .....                              | <b>372</b> |
| <b>Winter operation</b> .....  | <b>373</b> |
| <b>Draining the fresh water tank</b> .....                             | <b>374</b> |
| <b>Draining the water lines</b> .....                                  | <b>374</b> |
| <b>Draining the boiler</b> .....                                       | <b>375</b> |
| <b>Draining the 40-cup coffee machine</b> .....                        | <b>376</b> |
| <b>Draining the siphon</b> .....                                       | <b>377</b> |
| <b>Replacing fuses</b> .....   | <b>377</b> |
| <b>Malfunctions</b> .....  | <b>380</b> |
| <b>Restoring boiler operation following a malfunction</b> .....        | <b>380</b> |
| <b>Using the sausage heater again after a malfunction</b> .....        | <b>382</b> |
| <b>Using the 40-cup coffee machine again after a malfunction</b> ..... | <b>382</b> |



|   |            |
|---|------------|
| <b>Using the 2-carafe filter system again after a malfunction</b> ..... | <b>383</b> |
| <b>Other malfunctions</b> .....   | <b>384</b> |
| <b>Switching off the kitchenette</b> .....                              | <b>385</b> |

## General information

### General information



#### Caution:

Never operate the equipment without water. Risk of thermal damage - loss of warranty.



#### Danger.

To avoid the risk of fire and damage, it is prohibited to store anything inside the sausage heater or microwave oven.



#### Danger.

Use only clean drinking water.



#### Danger.

To prevent the growth of microbes in water left inside the system, the entire system must be drained (refer to “Winter operation”) if the galley and/or lavatory is to remain out of service temporarily.



#### Note:

It is advisable to disinfect water-carrying systems at regular intervals or after operation has been restored. A sodium hypochloride solution (from camping and caravanning retailers) is particularly suitable; observe the manufacturer's instructions.



#### Caution:

Do not use the coffee machine, water boiler or sausage heater unless the kitchenette is open. Damage caused by heat and steam when the kitchenette is closed is not covered by the warranty.



#### Danger.

Secure loose objects in the kitchenette (cans, cups, lids, etc.) properly during the journey.



#### Note:

Waste water from the galley flows into the lavatory's holding tank.



#### Environmental protection

Dispose of waste in an environmentally responsible manner. The rules and regulations of the country in which the vehicle is operated must be observed.

## Instructions for operating a microwave oven

## Instructions for operating a microwave oven

**Caution:**

Never use the oven when it is empty. Place at least one glass of water in the oven if you want to carry out a test. No metal objects should be placed in the oven interior as this would result in sparking and damage to the oven.

**Danger.**

Living animals or body parts must not be exposed to microwaves.

**Danger.**

To reduce the risk of a fire breaking out as a consequence of overheated food, the microwave oven must never be operated without supervision. If food catches fire, switch the microwave oven off but do not open the oven doors.

**Danger.**

Microwaves only heat up foods containing water; this means that the container may feel cold but the food inside could be boiling hot. To eliminate the risk of burns, the temperature of the food must therefore be checked before the food is served. This applies to the preparation of food for children or babies in particular.

**Danger.**

The rules below for handling microwave ovens must be adhered to in order to reduce the risk of microwaves causing burning, electric shocks, radiation and fire:

- Only use suitable containers. A container is suitable for use in the microwave oven if it remains cold after having been heated in the oven for one minute at maximum power.
- Do not operate the microwave oven with the door open, it is possible that

dangerous microwave energy may escape.

- Do not bridge the door safety circuit.
- Do not place any objects between the microwave oven door and the oven interior, keep the door seals clean.
- Do not use the oven if it is faulty.
- Only allow the microwave oven to be repaired by a specialist workshop.
- All openings on the microwave oven (ventilation in and out) must be free.
- Never allow children to use the microwave oven unless they are supervised.
- To reduce the risk of fire in the oven interior: foodstuffs must never be overheated, binding wires must be removed from paper or plastic packaging.
- Do not heat popcorn in the microwave oven unless you do this using a popcorn insert or use special popcorn.

### Instructions for operating a microwave oven

- Only use thermometers recommended for use in microwave ovens to measure the temperature of foodstuffs in the oven.
- Our instructions must be closely followed when cooking pork. The meat must be heated to at least 70 °C so that any bacteria that may be present will definitely be destroyed.
- Frozen drinks contained in narrow-necked bottles, especially carbonated drinks, must not be defrosted in the microwave oven. Pressure can form even in open containers with the effect that the container may explode and cause injuries.
- Foodstuffs must not be overcooked. If, for instance, potatoes are overcooked they can dry out and become a fire risk.
- Cooking of eggs (in or not in a shell) in the microwave oven cannot be recommended. The pressure in the egg yolk could cause the egg to explode and cause injuries.
- Foodstuffs in skins, such as potatoes, sausages, tomatoes, chicken livers and other offal, eggs, etc., should be pierced so that steam generated by cooking can escape.
- Microwaveable bags and sealed plastic bags should be cut open or pierced to prevent them exploding during cooking and possibly causing injuries. Plastic containers should be opened at least a small amount. After containers have been cooked while they were sealed with plastic foil, the cover must be removed in such a way that escaping steam does not come into contact with the hands or face.
- The microwave oven must not be used to dry paper (newspapers). They can catch fire if overheated.



#### **Danger.**

When liquids (water) are heated in the microwave oven, and especially reheated, it can sometimes happen that the boiling temperature has been reached but the typical steam bubbles do not initially form. The liquid does not boil uniformly. When the container is removed (shaken) this boiling delay, as it is called, can suddenly cause steam bubbles to form and therefore start to boil over suddenly - risk of scalding. To prevent this, it is necessary to place a glass rod in the container, for instance. The glass rod ensures that fluid in the container boils uniformly and therefore the steam bubbles form at the usual time.

**Note:**

Clean microwave ovens after they have been used with a commercially available washing detergent, do not use abrasive cleaner. Switch off the ignition when doing this. If it is necessary to clean dried-on food residue from the oven interior, it can be softened by placing a glass of water in the oven and boiling it for approximately 10 minutes.

**Use for the intended purpose**

The galley and its equipment are intended for normal kitchen use during a bus journey. This includes:

- Boiler for hot water preparation
- Coffee machine for brewing coffee
- Sausage heater for preparing sausages

Any other use cannot be considered use for the intended purpose.

**Approved personnel**

The kitchenette may only be used by trained personnel. The personnel must be professionally qualified and have read and understood this section.

The safety of the person using the kitchenette and the security of all kitchen utensils are prerequisites for use of the kitchenette while the bus is in motion.

**Danger.**

Objects being thrown out of the kitchenette can cause injuries. The person using the kitchenette must secure loose objects safely while the bus is in motion.

### First use of the galley

#### First use of the galley

- ▶ Galley switched on
- ▶ Fresh water tank filled and connected
- ▶ All packaging materials must be removed before the galley is used for the first time. All utensils must be thoroughly cleaned and rinsed in fresh water.



#### Environmental protection

Dispose of the packaging material in an environmentally responsible manner.

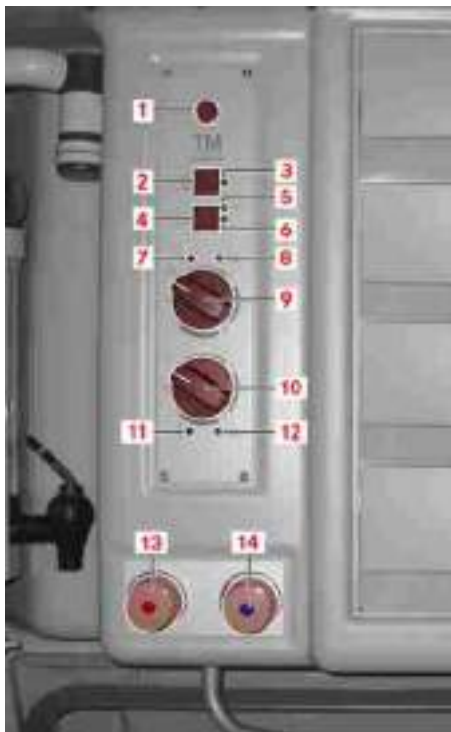

M86\_00-0375-73

- ▶ Press button (4) on the control panel and keep it pressed (yellow LED (6) flashes) until green LED (5) lights up.

The boiler has been filled and bled and can now be switched on using control button (9) to draw hot water.



#### Note:

To avoid scale and steam, do not turn control knob (9) to maximum temperature unless you need very hot water.

- ▶ Before first use, clean the sausage heater tank, the lid and the overflow pipe thoroughly with hot water and a commercially available washing up liquid, and then rinse well with clean water. Then wipe the sausage heater tank dry to avoid scaling.
- ▶ To clean the coffee machine, fill it with water and brew the water without coffee powder but with the filter holder fitted, then repeat.

The galley is ready for use.

### Switching on the kitchenette



#### Note:

The coffee machine, boiler, sausage heater and microwave oven cannot be operated unless the engine is running.



M54.00-1931-71

- ▶ Press kitchenette master switch (1).  
The LED in master switch (1) lights up.

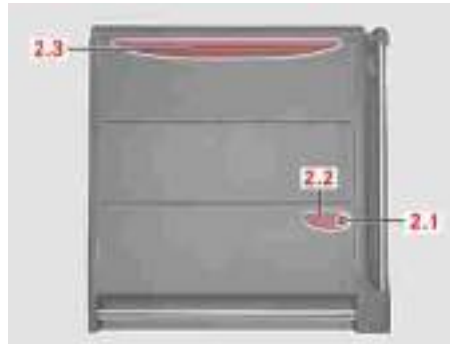

M86\_00-0140-01

- ▶ Release folding cover on lock (2.1) by unlocking and pressing it. Pull handle (2.2). Fold the upper part of the folding cover down by handle (2.3).



#### Danger.

Since the counter protrudes into the steps area, the kitchenette should be switched off and closed before passengers embark or disembark. Risk of injury.



#### Note:

The lower and middle covers can now be used as a counter.

### Filling the fresh water tank inside the bus

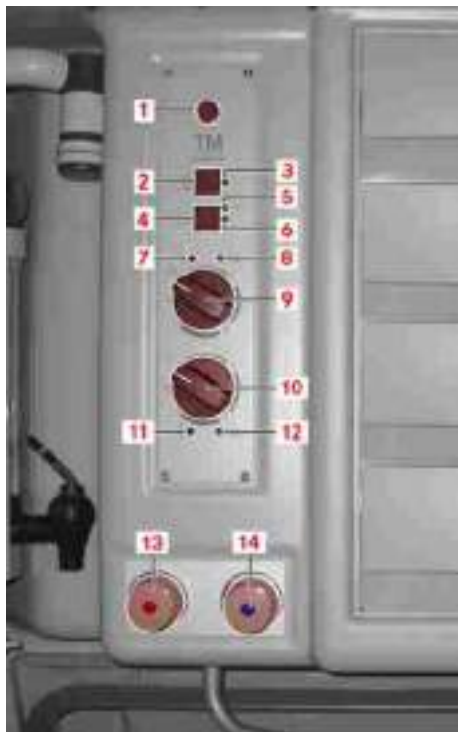

M86\_00-0375-73

- ▶ Switch on the kitchenette lighting using button (2) on the kitchenette control panel.

The LEDs of the kitchenette lighting come on and indicator lamp (3) lights up.

The kitchenette is open and ready for use.



#### Note:

If indicator lamp (3) on the control panel does not light up, there is insufficient on-board voltage to operate the kitchenette. Start the engine to enable the batteries to recharge.

### Filling the fresh water tank inside the bus



M86\_00-0142-02

- ▶ Fill fresh water tank (4) via cap (4.1).



## Filling the fresh water tank inside the bus

**Danger.**

The kitchenette must be operated using clean and potable water only. Fresh water for kitchenette requirements must be renewed every day. If the fresh water is stored in the water tank for a long period of time, an additive (Micropur, mat. no. 0.971.407.000) in accordance with the manufacturer's instructions must be mixed with it.

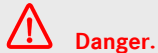
**Danger.**

The tools used to fill with water (containers, funnels, hoses, etc.) must be sterile.

**Note:**

It is recommended that fresh water tank (4) be cleaned manually via caps (4.1) and (4.2) and/or that it be flushed thoroughly with fresh water. The fresh water lines should then also be flushed with fresh water by drawing cold/hot water and switching on the coffee machine.

**Note:**

Use spanner (4.3) if the caps are difficult to turn.

**Note:**

In new buses, the drinking water may sometimes taste of plastic. An additive (Kunststoff-Frisch, mat. no. 0.971.405.000) can be mixed in accordance with the manufacturer's instructions to neutralise this aftertaste.

**Note:**

The fresh water tank is located in the luggage compartment in front of the lavatory, and in the right-hand luggage compartment to the rear of the driven axle on earlier bus models.

**Note:**

Waste water from the kitchenette flows into the lavatory's holding tank.

### Filling the fresh water tank outside the bus

#### Filling the fresh water tank outside the bus

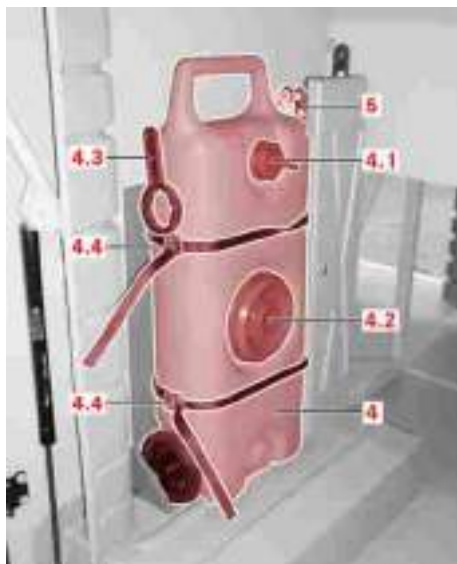

M86\_00-0142-02

- ▶ Disconnect quick-release coupling (5) from fresh water tank (4).

- ▶ Release tensioning straps (4.4). Remove fresh water tank (4).
- ▶ Fill fresh water tank (4) with pure drinking water via cap (4.2). Close cap (4.2) firm and tight.
- ▶ Fit fresh water tank (4) into the bus and secure using tensioning straps (4.4).
- ▶ Connect quick-release coupling (5) to fresh water tank (4).

#### Checking and cleaning the fresh water filter

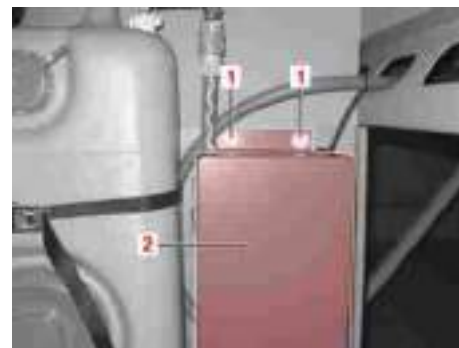

M86\_00-0376-71

- ▶ The fresh water filter is located behind cover (2). Unscrew knurled screws (1) to permit removal of the cover.

## Drawing water from the water tap

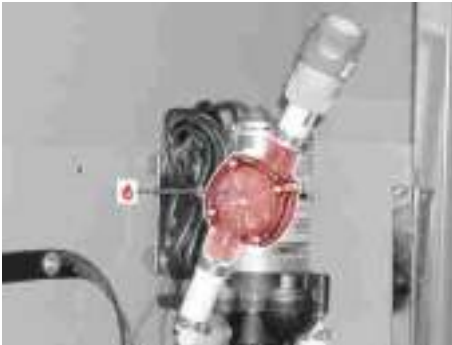

M86\_00-0143-01

- ▶ Check fresh water filter (6) for clogging at regular intervals (depending on the water quality) and clean it if necessary.

### **i** Note:

The fresh water filter is located between the fresh water tank and the fresh water pump.

### Drawing water from the water tap

- ▶ Galley switched on
- ▶ Fresh water tank filled and connected

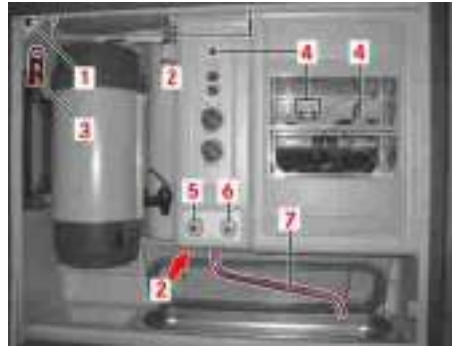

M86\_00-0377-71

- ▶ Open rotary knob (6) to draw cold water from tap (7).

- ▶ Open rotary knob (5) to draw hot water from tap (7).



**Danger.**

Outflow of hot water - danger of scalding.



**Note:**

No hot water can be drawn unless the boiler is in operation. It takes approximately 20 minutes for the water to heat up to a set temperature of 80 °C.



**Note:**

Opening both rotary knobs (5) and (6) draws a mixture of hot and cold water.

## Switching on the boiler

### Switching on the boiler

- ▶ Galley switched on
- ▶ Fresh water tank filled and connected



#### Caution:

There is a risk of overheating and thermal damage if the boiler is operated with no water. Never operate the boiler without water.

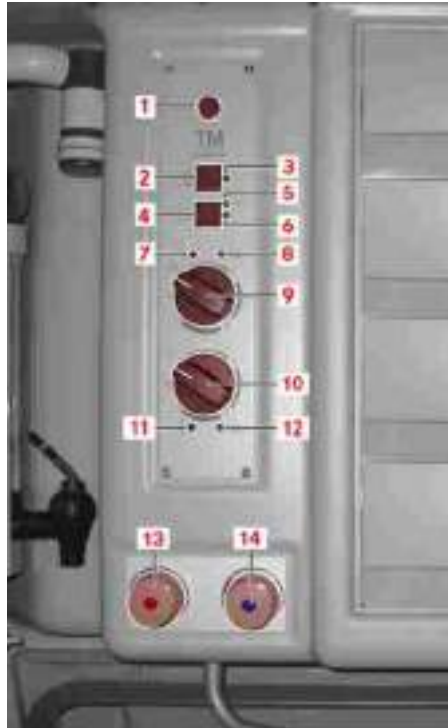

M86\_00-0375-73

- ▶ Before you switch on the boiler, press and hold button (4) until green LED (5) lights up in order to make sure that the boiler contains water.

The boiler has been filled with water and bled.

- ▶ To switch on the boiler, turn control knob (9) clockwise.

Green LED (8) above control knob (9) lights up and the water is heated.



#### Note:

The boiler switches off when you turn control knob (9) back. Green LED (8) goes out.



#### Note:

If red LED (7) lights up, the boiler has overheated and must be switched off by turning control knob (9) fully anti-clockwise (position 0) until the boiler has cooled down.

The boiler heats up the water and automatically switches off when the

## Descaling the boiler

temperature set at the control knob has been reached. LED (8) goes out.

### **i** Note:

The boiler has a capacity of approximately 5 litres and it takes approximately 20 minutes for the water to heat up to a set temperature of 80 °C.

### Descaling the boiler

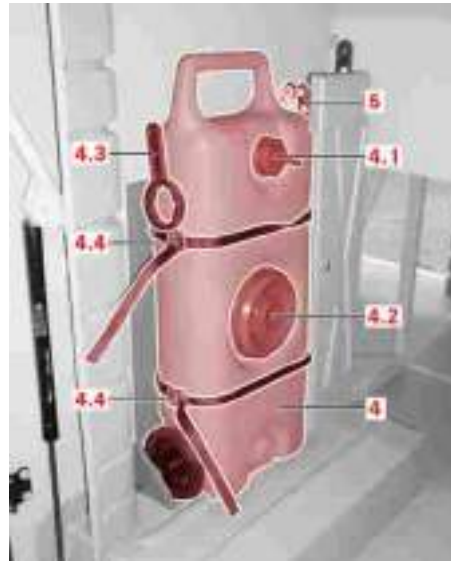

M86\_00-0142-02

- ▶ Disconnect the hose at quick-release coupling (5).

### **i** Note:

How frequently the galley should be descaled depends on the water quality but the boiler should be descaled immediately if there is a noticeable increase in the length of the heating phase. It is advisable to descale the boiler twice a year.

- ▶ Hold the hose in a container of descaler (at least 10 litres).

### **i** Note:

Use only descalers that are suitable for domestic appliances. The descaler must be non-aggressive to plastics and aluminium. Observe the information provided by the manufacturer.

### Descaling the boiler



#### Note:

Fully drain the boiler descaling.

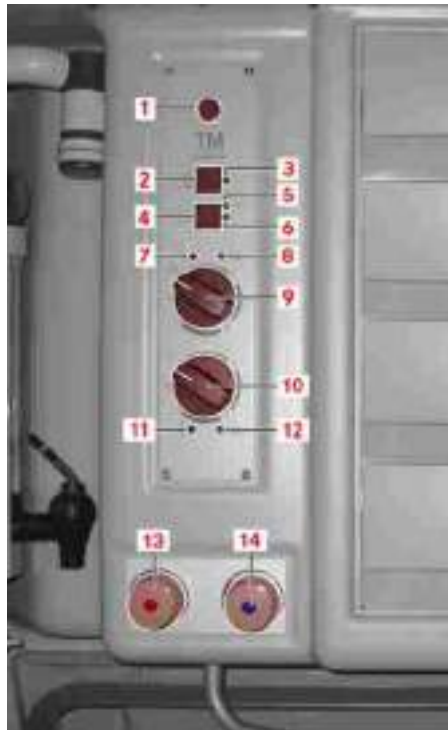

M86\_00-0375-73

- ▶ Press and hold pushbutton (4) until green LED (5) lights up.

The boiler has been filled with descaler.

- ▶ To switch on the boiler, turn control knob (9) fully clockwise (position 3).

LED (8) lights up and the water containing descaler is heated.

- ▶ Wait until LED (8) goes out.

The contents of the boiler have been heated.



#### Note:

The boiler has a capacity of approximately 5 litres and it takes approximately 20 minutes for the water to heat up to a set temperature of 80 °C.

- ▶ Drain the water and descaler by opening tap (5).

## Switching on the sausage heater

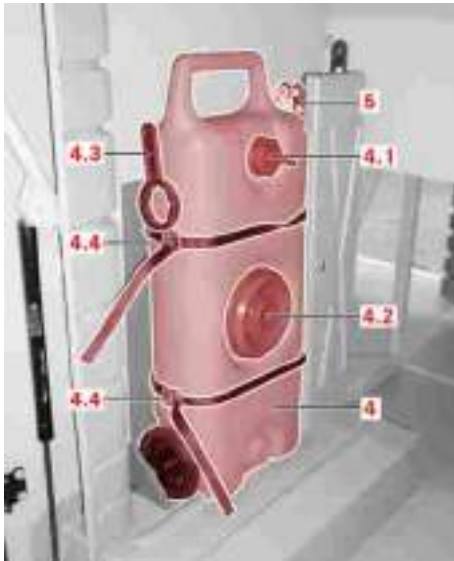

M86\_00-0142-02

- ▶ Connect the hose to fresh water tank (4).

- ▶ Flush the boiler with plenty of fresh water. To do this, fill the boiler with fresh water, heat the water and drain it.

**i** **Note:**

Repeat the last step until the water no longer tastes or smells of descaler or vinegar.

### Switching on the sausage heater

- ▶ Galley switched on
- ▶ Fresh water tank filled and connected

**!** **Danger.**

There is a risk of scalding when using the sausage heater. Hot steam can rise, which may cause serious burns to the face, arms and hands. Keep at a safe distance, and remove hot sausages using only heat-resistant kitchen utensils.

**i** **Note:**

The length of the heating phase depends on the amount of water, the number of sausages and the temperature of the water used to fill the boiler.

### Switching on the sausage heater



**Note:**

The sausage heater has a capacity of 8.5 litres.



**Note:**

Waste water from the galley flows into the lavatory's holding tank.

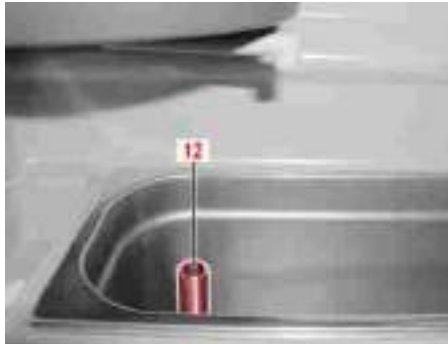

M86\_00-0149-01

- ▶ Insert overflow pipe (12) into the discharge hole, ensuring leak-tightness.



**Danger.**

Never use the sausage heater without water.



**Note:**

Excess water may run out via overflow pipe (12).

- ▶ Fill the sausage heater tank half full (approximately 2 - 3 litres) with cold or hot water.
- ▶ Add the sausages to the sausage heater tank and replace the lid on the sausage heater tank.



**Note:**

When adding sausages, there is a risk of hot water splashing and causing burns to the face, arms and hands. Add the sausages to the water carefully and keep a safe distance.



## Switching on the sausage heater

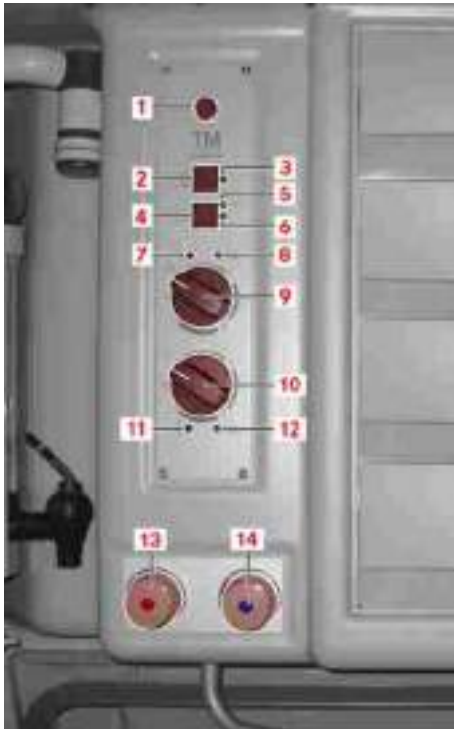

M86\_00-0375-73

- ▶ Switch on the sausage heater by turning control knob (10).  
Green LED (12) lights up during the heating phase.

**i** **Note:**

If red LED (11) lights up, the sausage heater has overheated and must be switched off by turning the control knob fully anti-clockwise (position 0) until the heater has cooled down.

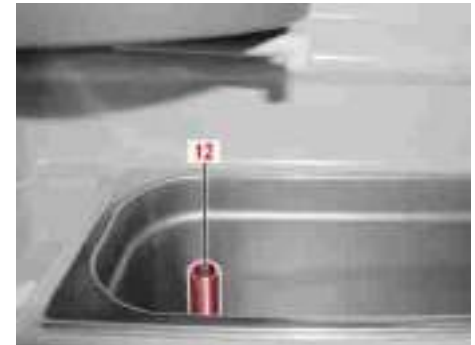

M86\_00-0149-01

- ▶ At the end of the heating phase, remove the lid.

**!** **Danger.**

The sausage heater is hot and generates steam - risk of scalding. Do not remove overflow pipe (12) until the water in the tank has cooled sufficiently that there is no longer a risk of scalding.

- ▶ Take out the sausages using tongs or a suitable heat-resistant kitchen utensil.

### Cleaning the sausage heater

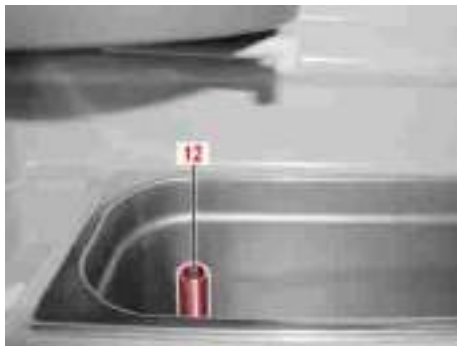

M86\_00-0149-01

- ▶ The water in the sausage heater tank can be drained as soon as the water has been allowed to cool down. To do this, remove overflow pipe (12) from the discharge hole.

#### Cleaning the sausage heater

- ▶ After use, clean the sausage heater tank, the lid and the overflow pipe with warm water and a commercially available washing up liquid. Use a soft sponge without a scourer or similar abrasive product. Rinse with clean water and wipe the sausage heater tank dry to avoid scaling. Clean the overflow pipe with bottle cleaner at regular intervals.



#### Note:

Clean the sausage heater tank with a commercially available stainless steel cleaner at regular intervals.

#### Descaling the sausage heater

- ▶ Fill the sausage heater tank 2 cm high with descaler.
- ▶ Leave the descaler to work (observe the information issued by the manufacturer).



#### Note:

For heavy scaling, it is possible to operate the sausage heater containing descaler for approximately 30 minutes at 80 °C.

- ▶ Drain the boiler after the descaler reaction time and rinse well with clean water. Wipe the sausage heater tank dry.

### Switching on the 40-cup coffee machine

- ▶ Galley switched on
- ▶ Fresh water tank filled and connected



#### Note:

There is a risk of scalding when serving hot drinks. There is a risk of serious burns. Do not pour the coffee until it is safe to do so.



#### Danger.

Do not switch on the coffee machine unless its tank has been filled with water - risk of overheating.

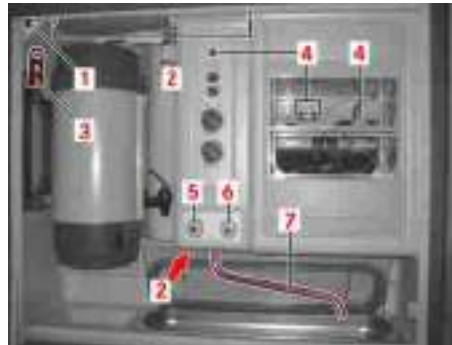

M86\_00-0377-71

- ▶ Pulling release handle (3) up makes it possible to pivot the coffee machine out of the kitchenette



M86\_00-0010-01

- ▶ Pivot the 40-cup coffee machine out of the galley. Close residual drain valve (24) and tap (23).

### Switching on the 40-cup coffee machine



M86\_00-0008-01

- ▶ Open the lid. Turn lock ring (17) anti-clockwise and unlock it.



M86\_00-0010-01

- ▶ Remove lock ring (17) and lid (18) and take out filter holder (19).
- ▶ Pivot the 40-cup coffee machine into the galley until it engages.



M86\_00-0378-71

- ▶ Open tap (1) to fill the 40-cup coffee machine with water.



#### Note:

The minimum amount of water to fill the 40-cup coffee machine is the equivalent of 10 cups. The maximum amount of water is the equivalent of 40 cups. The number of cups is indicated at water level glass (21).

## Switching on the 40-cup coffee machine



M86\_00-0010-01

- ▶ Insert the filter paper into filter holder (19) and fill filter holder (19) with the required amount of coffee (1 mark ring = 10 cups).

**i** **Note:**

You can also use the machine without paper if the coffee has not been ground too fine.

- ▶ Close filter holder (19) and lid (18) and place it on the riser pipe in the machine.



M86\_00-0008-01

- ▶ Position lid (18) and lock ring (17) on top and engage by turning anti-clockwise:

**i** **Note:**

Lug (17.1) must be positioned over water level glass (21).



M86\_00-0010-01

- ▶ Switch on the 40-cup coffee machine using rocker switch (22). The brewing process begins.

**⚠** **Danger.**

Whilst coffee is being brewed, steam escapes from the openings in the lid. Do not open the lid when the coffee machine is switched on.

### Switching on the 40-cup coffee machine



#### Note:

Indicator lamp (22.1) lights up when the coffee has finished brewing.



#### Note:

The coffee is kept warm as long as rocker switch (22) has not been switched off.



#### Note:

Do not switch off the coffee machine during the keep-warm phase because a new brewing process would begin when the machine were switched back on - coffee quality would be degraded.

- ▶ Push tap (23) down to pour coffee. Lock it in the vertical position for continuous pouring.



#### Note:

Lock the tap in the vertical position for continuous pouring.

- ▶ Switch off rocker switch (22) if there is no more coffee in the coffee machine or no more coffee is needed.



M86\_00-0159-02

- ▶ Drain off the remaining coffee with residual drain valve (24).

### Brewing coffee in winter



#### Caution:

Operation of the 40-cup coffee machine in winter is permitted only once it has been established that the interior of the kitchenette is not frozen, otherwise there is a risk of damage. The interior compartment of the bus should be heated for some time beforehand.



M86\_00-0010-01

- ▶ Remove lid (18) and filter holder (19). Use a suitable vessel to fill water into the coffee machine container and switch on the machine.

### Cleaning the 40-cup coffee machine

- ▶ Galley switched on



#### Note:

Regular cleaning after each use ensures optimum coffee quality and full taste.

- ▶ Clean the filter holder using a commercially available washing up liquid and a brush. Do not use a descaler when cleaning the filter holder.
- ▶ Clean the inside of the riser pipe of the 40-cup coffee machine with a cloth and stainless steel cleaner.



#### Note:

The bottom of the tank, the opening on the riser pipe and the diaphragm must be free of coffee residues.

- ▶ To remove the water level glass, remove the catch at the top. Clean the water level glass using a pipe cleaner or a bottle brush. After cleaning, press the catch back into the water level glass, ensuring leak-tightness.

### Descaling the coffee machine

- ▶ To clean the tap, unscrew the upper part with rocker arm and flush with clean water.
- ▶ Flush the residual drain valve with clean water.

#### Descaling the coffee machine



#### Note:

How frequently the galley should be descaled depends on the water quality but the coffee machine should be descaled immediately if performance deteriorates or if the openings in the filter begin to scale up.



M86\_00-0142-02

- ▶ Disconnect the hose at quick-release coupling (5).



- ▶ Hold hose in a container of descaler (at least 10 litres).

**Note:**

Use only descalers that are suitable for domestic appliances. The descaler must not attack plastics and aluminium.

- ▶ Operate the 40-cup coffee machine without the filter holder and with the tank full or operate the 2-carafe filter system with two carafes.

**Note:**

Clean the filter holder of the 40-cup coffee machine using only a commercially available washing up liquid and a brush.

- ▶ Connect the hose to fresh water tank (4).

- ▶ Flush with fresh water. To do this, brew several carafes without coffee.

**Note:**

Repeat the last step until the water no longer tastes or smells of descaler or vinegar.

**Winter operation**

- ▶ Galley switched on
- ▶ Over winter, drain the fresh water tank, water lines, boiler, coffee machines and siphon.

**Note:**

To prevent damage to water-carrying installations, these must be completely drained before the first frost.

## Draining the fresh water tank

### Draining the fresh water tank

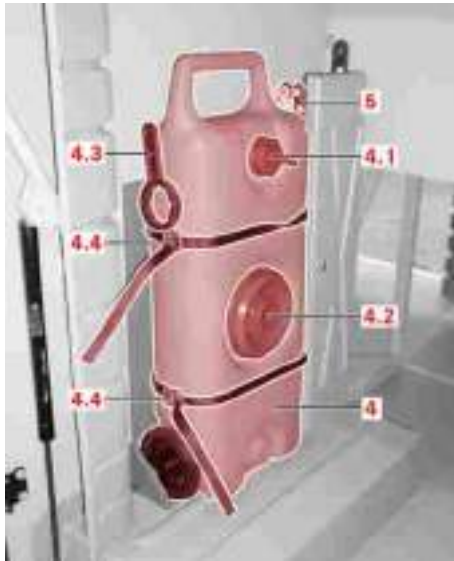

M86\_00-0142-02

- ▶ Disconnect quick-release coupling (5) from fresh water tank (4).

- ▶ Release both tensioning straps (4.4).
- ▶ Remove fresh water tank (4) from the bus and open cap (4.1) to completely drain the water.



#### Note:

Use spanner (4.3) if the caps are difficult to turn.

- ▶ Close cap (4.1) firm and tight. Fit fresh water tank (4) into the bus and secure using tensioning straps (4.4). Connect quick-release coupling (5) to fresh water tank (4).

The fresh water tank is completely drained.

### Draining the water lines

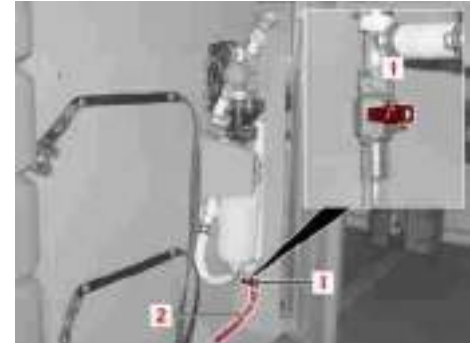

M86\_00-0305-71

- ▶ To drain off the majority of the water, route hose (2) to the outside of the bus and open tap (1).



#### Note:

The tap is located in the luggage compartment next to the fresh water tank or below the water pump.

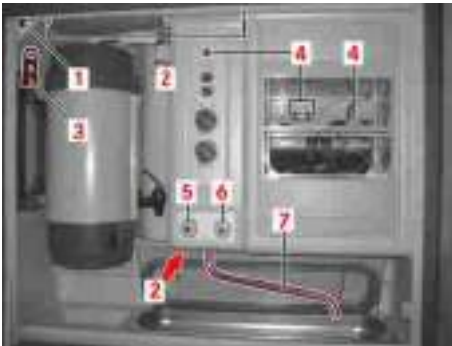

M86\_00-0377-71

- ▶ To drain off the remaining water, open cold water tap (5) and hot water tap (6) and allow the boiler to drain empty.

The water lines are completely drained.

### Draining the boiler



#### Caution:

There is a risk of overheating if the boiler is operated with no water. Switch off the boiler before draining it.



#### Note:

The drain plug is located on the bottom left behind the folding cover of the galley.



M86\_00-0306-71

- ▶ Pull out hose (36) on the left-hand side behind the folding cover.
- ▶ Position a heat-resistant container (minimum capacity of 5 litres) under the end of the hose sealed with a red or black drain plug (36.1).



#### Danger.

Hot water may flow out when the boiler is drained. Do not allow your hands or arms to come into contact with the water.

### Draining the 40-cup coffee machine

- ▶ Open hose clamp (36.2), remove red or black drain plug (36.1) and drain all the water from the boiler into the container underneath.
- ▶ Seal hose (36) with the red or black drain plug (36.1). Secure drain plug (36.1) firmly in place using hose clamp (36.2). Slide hose (36) back into the galley.

The boiler is completely drained.

#### Draining the 40-cup coffee machine



M86\_00-0159-02

- ▶ Position residual drain valve (37) over drainage basin (38).

- ▶ Turn residual drain valve (24) to the open position to drain the residual water from the 40-cup coffee machine.

The residual water drains out.

- ▶ Turn residual drain valve (24) back to the closed position.

The 40-cup coffee machine is completely drained and sealed.

### Draining the siphon



#### Note:

The siphon of the galley waste water drain is located in the 2nd step in doorway II.



M86\_00-0160-01

- Disassemble and empty the siphon (39) (odour trap) for the kitchenette waste water drain at union nuts (39.1).

- Fill the siphon with windscreen anti-freeze mat. no. A 001 986 45 71 11 (down to  $-30\text{ }^{\circ}\text{C}$ ) and then reassemble it.

### Replacing fuses



#### Danger. Risk of fire.

Do not use fuses with a higher than specified amperage.

The result would be damage to the electrical system or even a fire in the cables.

- Always use fuses of the specified amperage and never attempt to bridge or rewire fuses.
- Fuses should be replaced only when the cause of malfunction has been rectified.



#### Danger.

Do not replace fuses unless the power has been switched off.

### Replacing fuses



#### Note:

This description is based on the standard assignment of fuses in the bus. Bus-specific assignment may differ from bus to bus. Not all fuse slots are necessarily occupied in every bus. Furthermore, fuses may occupy unassigned slots because they are protecting special customer options or retrofitted equipment, for example.



M54.00-1931-71

- ▶ Switch off the galley at master switch (1).

The LED goes out.

- ▶ Switch off the engine.



M54.00-2004-71

- ▶ Switch battery isolating switch (01S01) to OFF.

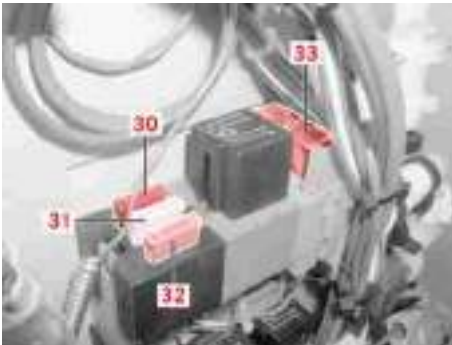

M86\_00-0180-71

- Exchange the defective galley fuse.

**i** **Note:**

The fuses for the galley are located on the back of the galley behind the mirror in the lavatory. The mirror can be removed (screws, mirror bracket or Velcro fasteners).

**i** **Note:**

30 Water pump (10 A)

**i** **Note:**

31 Sausage heater (25 A)

**i** **Note:**

32 Electronics (5 A)

**i** **Note:**

33 Coffee machine (40 A)



M86\_00-0181-71

- Exchange the defective boiler fuse.

**i** **Note:**

The fuses for the boiler are located under the plastic cover. To remove the plastic cover, undo the two screws in the cup recesses and the screw in the carafe recess. Lift the back of the plastic cover approximately 5 cm and slide it forwards to free the plastic cover from the pipe of the cup dispenser.

## Malfunctions



### Note:

34 Terminal 15 (5 A)



### Note:

35 D+ (engine) (5 A)



### Note:

36 Water pump (10 A)



### Note:

37 Boiler (50 A)

## Malfunctions

- ▶ This section describes malfunctions that you can rectify yourself.

## Restoring boiler operation following a malfunction

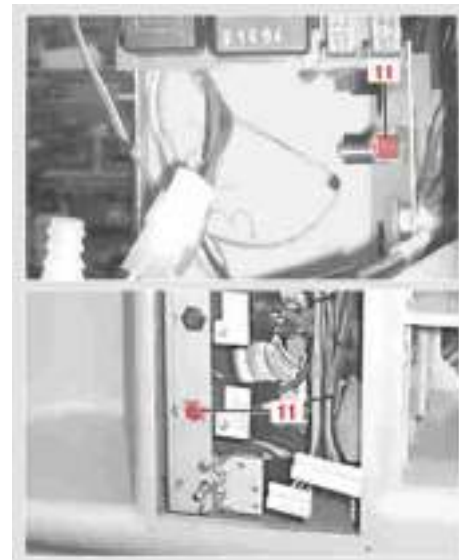

M86\_00-0148-02



## Restoring boiler operation following a malfunction

- ▶ The overheating protection is triggered if the boiler is operated with no water.

**i** **Note:**

Fill the boiler with water to rectify the malfunction. Reactivate the overheating protection by pressing button (11) behind the control panel.

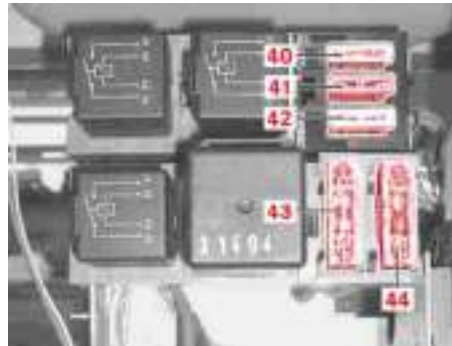

M86\_00-0162-01

- ▶ The boiler does not heat up.

**i** **Note:**

Replace fuse (44) to rectify the malfunction.

- ▶ Insufficient hot water flow or excessive heating time.

**i** **Note:**

Symptom of scaling, descale the boiler.

- ▶ Water flows out of the tap when the boiler is heating.

**i** **Note:**

No malfunction, because water expands during the heating process.

### Using the sausage heater again after a malfunction

#### Using the sausage heater again after a malfunction

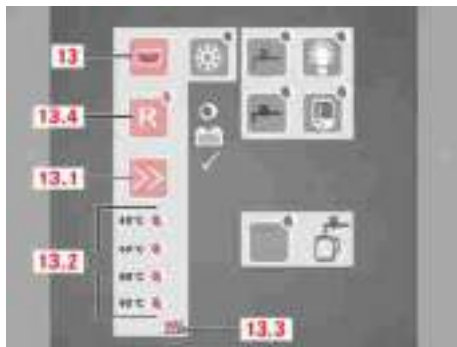

M86\_00-0165-01

- ▶ The overheating protection is triggered if the sausage heater is operated with no water. The red LED in button (13.4) lights up.

#### **i** Note:

Fill the sausage heater with water to rectify the malfunction. Reactivate the overheating protection by pressing button (13.4) on the control panel.

#### Using the 40-cup coffee machine again after a malfunction

- ▶ Heating is switched off by a temperature limiter if the coffee machine overheats.

#### **i** Note:

Pressing in the red pin at the base of the appliance reactivates the coffee machine (after approximately 5 - 10 minutes cooling down period)

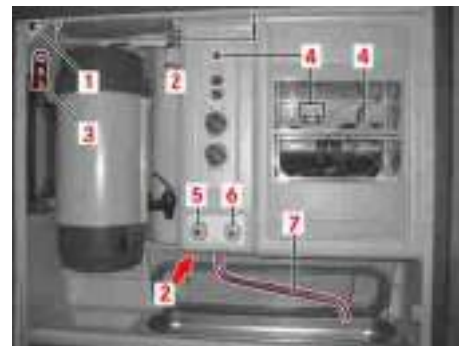

M86\_00-0377-71

- ▶ The indicator lamp does not light up.

#### **i** Note:

Check the power supply or replace fuse (4) if necessary.

## Using the 2-carafe filter system again after a malfunction

- ▶ The brewing process for 40 cups still has not finished after approximately 40 minutes.

**i** **Note:**

The riser pipe is not seated in the centre of the brewing chamber. Riser pipe or diaphragm blocked.

- ▶ Coffee machine boils over.

**i** **Note:**

Too much water added. Coffee powder too fine. Filter holder clogged or blocked. Lid not locked.

- ▶ Dripping tap.

**i** **Note:**

Dirt, e.g. coffee residue, clean the tap. Screw connection leaking, replace the seal.

- ▶ No water level in the water level glass even though the coffee machine is full.

**i** **Note:**

Lower inlet opening blocked. Clean the inlet opening from the inside, remove the water level glass if necessary.

- ▶ Water dripping from residual drain valve.

**i** **Note:**

Dirt, e.g. coffee residue, unscrew the angle piece and clean the tap. Screw connection leaking, replace the seal.

### Using the 2-carafe filter system again after a malfunction

- ▶ A continuous tone indicates that the fresh water tank is empty.

**i** **Note:**

Fill the fresh water tank. Press any button on the control panel of the 2-carafe filter system. The 2-carafe filter system resumes the program from the point at which it was interrupted.

## Other malfunctions



M86\_00-0157-01

- ▶ Overheating protection triggered.



### Note:

To reactivate the 2-carafe filter system, press the overheat protection switch for left-hand carafe (34) or right-hand carafe (35) behind the control panel.

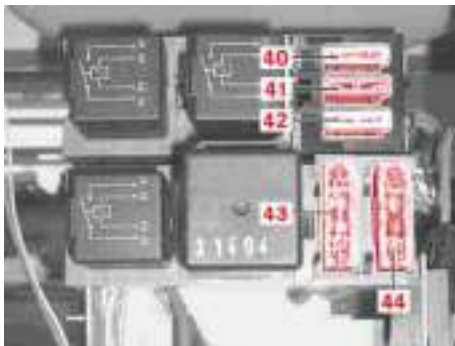

M86\_00-0162-01

- ▶ 2-carafe filter system fills with water but does not brew.



### Note:

Replace fuse (43) to rectify the malfunction.

## Other malfunctions

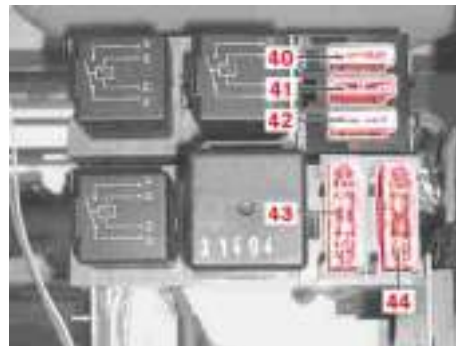

M86\_00-0162-01

- ▶ The control panel is not working.



### Note:

Either the fuse or the control panel is defective. Replace fuse (42) or have the control panel repaired by the after-sales service.

- ▶ Galley light does not switch on.



**Note:**

Change bulb (24 V/5 W) or replace fuse (42).



**Note:**

In the case of on-board kitchenettes with 40-cup coffee machine, the lighting features LED technology.

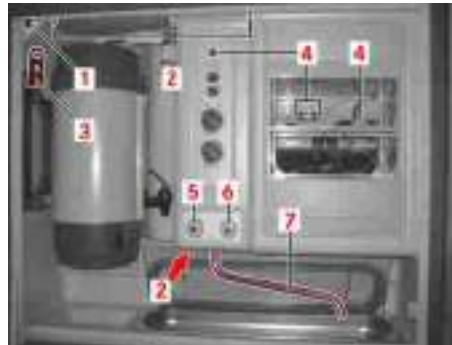

M86\_00-0377-71

► No water or irregular flow.



**Note:**

Fill the fresh water tank with water. Or replace fuse (41). Or have the water pump replaced by the after-sales service.



**Note:**

In the case of on-board kitchenettes with 40-cup coffee machine, replace defective fuse (4).

### Switching off the kitchenette



**Note:**

All appliances must be switched off before the kitchenette can be switched off.

### Switching off the kitchenette

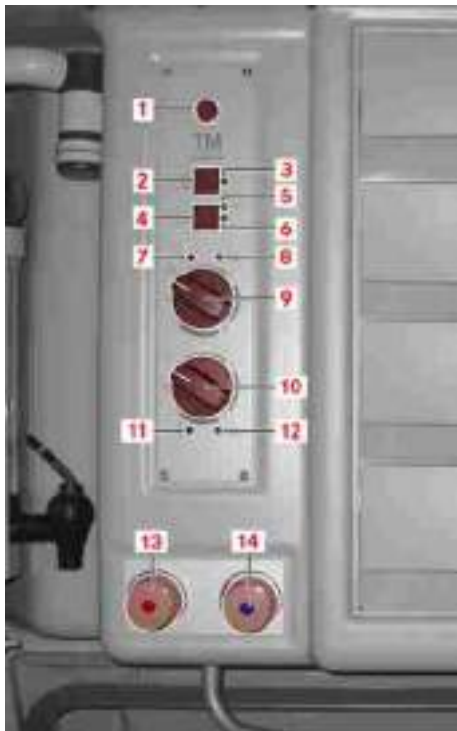

M86\_00-0375-73

- ▶ Switch off the kitchenette lighting using button (2) on the control panel.
- ▶ Fold the upper folding cover upwards through 90° and press against the guide rails. Pull the entire folding cover upwards by the upper folding cover.

The kitchenette is locked away.



M54.00-1931-71

- ▶ Press kitchenette master switch (1).  
The LED goes out.  
The kitchenette is switched off.

|   |            |
|---|------------|
| <b>General information</b> .....                          | <b>390</b> |
| <b>Instructions for operating a microwave oven</b> .....  | <b>391</b> |
| <b>Use for the intended purpose</b> .....                 | <b>393</b> |
| <b>Approved personnel</b> .....                           | <b>393</b> |
| <b>First use of the galley</b> .....                      | <b>394</b> |
| <b>Switching on the galley</b> .....                      | <b>395</b> |
| <b>Filling the fresh water tank inside the bus</b> .....  | <b>396</b> |
| <b>Filling the fresh water tank outside the bus</b> ..... | <b>397</b> |
| <b>Checking and cleaning the fresh water filter</b> ..... | <b>398</b> |
| <b>Drawing water from the water tap</b> .....             | <b>399</b> |
| <b>Switching on the boiler</b> .....                      | <b>400</b> |
| <b>Setting the thermostat</b> .....                       | <b>401</b> |
| <b>Descaling the boiler</b> .....                         | <b>402</b> |
| <b>Switching on the sausage heater</b> .....              | <b>404</b> |
| <b>Cleaning the sausage heater</b> .....                  | <b>407</b> |
| <b>Descaling the sausage heater</b> .....                 | <b>407</b> |

### Table of contents

|   |            |
|---|------------|
| <b>Switching on the 2-carafe filter system</b> .....            | <b>407</b> |
| <b>Brewing 1/2 a carafe of coffee (10 cups of coffee)</b> ..... | <b>408</b> |
| <b>Brewing 1 carafe of coffee (20 cups of coffee)</b> .....     | <b>409</b> |
| <b>Brewing 2 carafes of coffee (40 cups of coffee)</b> .....    | <b>409</b> |
| <b>Manual operation of the 2-carafe filter system</b> .....     | <b>410</b> |
| <b>Descaling the coffee machine</b> .....                       | <b>411</b> |
| <b>Winter operation</b> .....                                   | <b>412</b> |
| <b>Draining the fresh water tank</b> .....                      | <b>413</b> |
| <b>Draining the water lines</b> .....                           | <b>413</b> |
| <b>Draining the boiler</b> .....                                | <b>414</b> |
| <b>Draining the 2-carafe filter system</b> .....                | <b>415</b> |
| <b>Draining the siphon</b> .....                                | <b>416</b> |
| <b>Replacing fuses</b> .....                                    | <b>416</b> |
| <b>Malfunctions</b> .....                                       | <b>419</b> |
| <b>Restoring boiler operation following a malfunction</b> ..... | <b>419</b> |
| <b>Using the sausage heater again after a malfunction</b> ..... | <b>421</b> |



|   |            |
|---|------------|
| <b>Using the 2-carafe filter system again after a malfunction</b> ..... | <b>421</b> |
| <b>Other malfunctions</b> .....   | <b>422</b> |
| <b>Switching off the kitchenette</b> .....                              | <b>423</b> |

### General information

#### General information



#### Caution:

Never operate the equipment without water. Risk of thermal damage - loss of warranty.



#### Danger.

To avoid the risk of fire and damage, it is prohibited to store anything inside the sausage heater or microwave oven.



#### Danger.

Use only clean drinking water.



#### Danger.

To prevent the growth of microbes in water left inside the system, the entire system must be drained (refer to “Winter operation”) if the galley and/or lavatory is to remain out of service temporarily.



#### Note:

It is advisable to disinfect water-carrying systems at regular intervals or after operation has been restored. A sodium hypochloride solution (from camping and caravanning retailers) is particularly suitable; observe the manufacturer's instructions.



#### Caution:

Do not use the coffee machine, water boiler or sausage heater unless the kitchenette is open. Damage caused by heat and steam when the kitchenette is closed is not covered by the warranty.



#### Danger.

Secure loose objects in the kitchenette (cans, cups, lids, etc.) properly during the journey.



#### Note:

Waste water from the galley flows into the lavatory's holding tank.



#### Environmental protection

Dispose of waste in an environmentally responsible manner. The rules and regulations of the country in which the vehicle is operated must be observed.

## Instructions for operating a microwave oven

## Instructions for operating a microwave oven

**Caution:**

Never use the oven when it is empty. Place at least one glass of water in the oven if you want to carry out a test. No metal objects should be placed in the oven interior as this would result in sparking and damage to the oven.

**Danger.**

Living animals or body parts must not be exposed to microwaves.

**Danger.**

To reduce the risk of a fire breaking out as a consequence of overheated food, the microwave oven must never be operated without supervision. If food catches fire, switch the microwave oven off but do not open the oven doors.

**Danger.**

Microwaves only heat up foods containing water; this means that the container may feel cold but the food inside could be boiling hot. To eliminate the risk of burns, the temperature of the food must therefore be checked before the food is served. This applies to the preparation of food for children or babies in particular.

**Danger.**

The rules below for handling microwave ovens must be adhered to in order to reduce the risk of microwaves causing burning, electric shocks, radiation and fire:

- Only use suitable containers. A container is suitable for use in the microwave oven if it remains cold after having been heated in the oven for one minute at maximum power.
- Do not operate the microwave oven with the door open, it is possible that

dangerous microwave energy may escape.

- Do not bridge the door safety circuit.
- Do not place any objects between the microwave oven door and the oven interior, keep the door seals clean.
- Do not use the oven if it is faulty.
- Only allow the microwave oven to be repaired by a specialist workshop.
- All openings on the microwave oven (ventilation in and out) must be free.
- Never allow children to use the microwave oven unless they are supervised.
- To reduce the risk of fire in the oven interior: foodstuffs must never be overheated, binding wires must be removed from paper or plastic packaging.
- Do not heat popcorn in the microwave oven unless you do this using a popcorn insert or use special popcorn.

### Instructions for operating a microwave oven

- Only use thermometers recommended for use in microwave ovens to measure the temperature of foodstuffs in the oven.
- Our instructions must be closely followed when cooking pork. The meat must be heated to at least 70 °C so that any bacteria that may be present will definitely be destroyed.
- Frozen drinks contained in narrow-necked bottles, especially carbonated drinks, must not be defrosted in the microwave oven. Pressure can form even in open containers with the effect that the container may explode and cause injuries.
- Foodstuffs must not be overcooked. If, for instance, potatoes are overcooked they can dry out and become a fire risk.
- Cooking of eggs (in or not in a shell) in the microwave oven cannot be recommended. The pressure in the egg yolk could cause the egg to explode and cause injuries.
- Foodstuffs in skins, such as potatoes, sausages, tomatoes, chicken livers and other offal, eggs, etc., should be pierced so that steam generated by cooking can escape.
- Microwaveable bags and sealed plastic bags should be cut open or pierced to prevent them exploding during cooking and possibly causing injuries. Plastic containers should be opened at least a small amount. After containers have been cooked while they were sealed with plastic foil, the cover must be removed in such a way that escaping steam does not come into contact with the hands or face.
- The microwave oven must not be used to dry paper (newspapers). They can catch fire if overheated.



#### **Danger.**

When liquids (water) are heated in the microwave oven, and especially reheated, it can sometimes happen that the boiling temperature has been reached but the typical steam bubbles do not initially form. The liquid does not boil uniformly. When the container is removed (shaken) this boiling delay, as it is called, can suddenly cause steam bubbles to form and therefore start to boil over suddenly - risk of scalding. To prevent this, it is necessary to place a glass rod in the container, for instance. The glass rod ensures that fluid in the container boils uniformly and therefore the steam bubbles form at the usual time.

**Note:**

Clean microwave ovens after they have been used with a commercially available washing detergent, do not use abrasive cleaner. Switch off the ignition when doing this. If it is necessary to clean dried-on food residue from the oven interior, it can be softened by placing a glass of water in the oven and boiling it for approximately 10 minutes.

**Use for the intended purpose**

The galley and its equipment are intended for normal kitchen use during a bus journey. This includes:

- Boiler for hot water preparation
- Coffee machine for brewing coffee
- Sausage heater for preparing sausages

Any other use cannot be considered use for the intended purpose.

**Approved personnel**

The kitchenette may only be used by trained personnel. The personnel must be professionally qualified and have read and understood this section.

The safety of the person using the kitchenette and the security of all kitchen utensils are prerequisites for use of the kitchenette while the bus is in motion.

**Danger.**

Objects being thrown out of the kitchenette can cause injuries. The person using the kitchenette must secure loose objects safely while the bus is in motion.

### First use of the galley

#### First use of the galley

- ▶ Galley switched on
- ▶ Fresh water tank filled and connected
- ▶ All packaging materials must be removed before the galley is used for the first time.



#### Environmental protection

Dispose of the packaging material in an environmentally responsible manner.

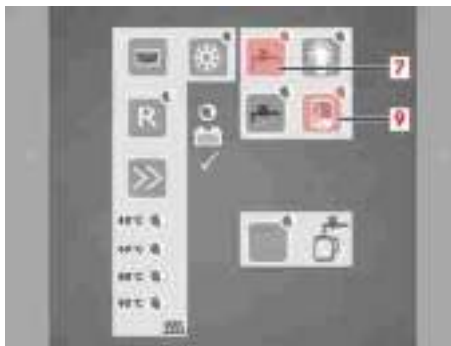

M86\_00-0147-01

- ▶ Press hot water button (7) on the control panel until cold water flows out of the tap.

The boiler has been filled and bled and can now be switched on using button (9) to draw hot water.

- ▶ Before first use, clean the sausage heater tank, the lid and the overflow pipe thoroughly with hot water and a commercially available washing up liquid, and then rinse well with clean water. Then wipe the sausage heater tank dry to avoid scaling.

- ▶ To clean the coffee machine, fill it with water and brew the water without coffee powder but with the filter holder fitted, then repeat.

The galley is ready for use.

### Switching on the galley



#### Note:

The coffee machine, boiler, sausage heater and microwave oven cannot be operated unless the engine is running.



M54.00-1931-71

- ▶ Press galley master switch (1).  
The LED in master switch (1) lights up.

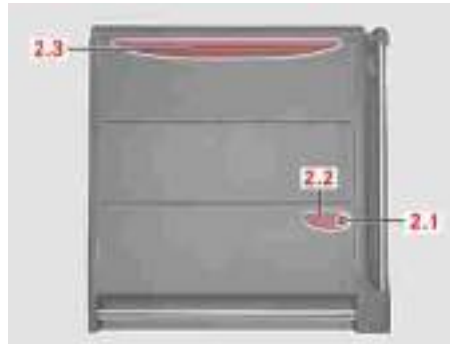

M86\_00-0140-01

- ▶ Release folding cover on lock (2.1) by unlocking and pressing it. Pull handle (2.2). Fold the upper part of the folding cover down by handle (2.3).



#### Danger.

Since the counter protrudes into the steps area, the kitchenette should be switched off and closed before passengers embark or disembark. Risk of injury.



#### Note:

The lower and middle covers can now be used as a counter.

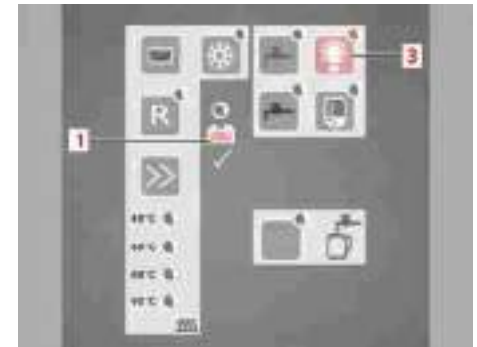

M86\_00-0141-01

- ▶ Switch on the galley lighting using button (2) on the galley control panel.  
The galley lighting LED lights up.  
The galley is open and ready for use.

### Filling the fresh water tank inside the bus



#### Note:

If battery (1) does not light up in green on the control panel, there is insufficient on-board voltage to operate the kitchenette. Start the engine to enable the batteries to recharge.

#### Filling the fresh water tank inside the bus

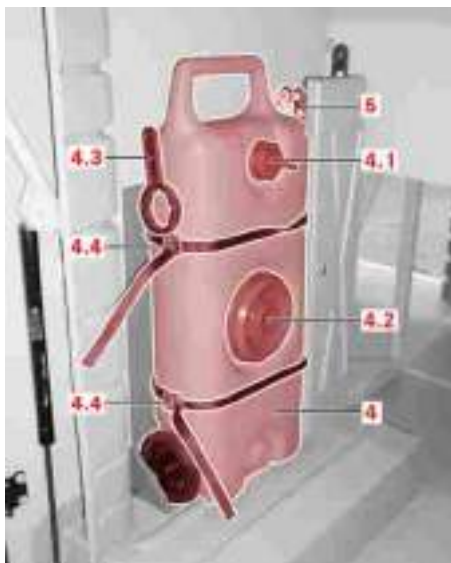

M86\_00-0142-02

- Fill fresh water tank (4) via cap (4.1).



#### Danger.

The kitchenette must be operated using clean and potable water only. Fresh water for kitchenette requirements must be renewed every day. If the fresh water is stored in the water tank for a long period of time, an additive (Micropur, mat. no. 0.971.407.000) in accordance with the manufacturer's instructions must be mixed with it.



#### Danger.

The tools used to fill with water (containers, funnels, hoses, etc.) must be sterile.



#### Note:

It is recommended that fresh water tank (4) be cleaned manually via caps (4.1) and (4.2) and/or that it be flushed thoroughly with fresh water. The fresh water lines should then also be flushed with fresh water by drawing cold/hot water and switching on the coffee machine.



## Filling the fresh water tank outside the bus



### Note:

Use spanner (4.3) if the caps are difficult to turn.



### Note:

In new buses, the drinking water may sometimes taste of plastic. An additive (Kunststoff-Frisch, mat. no. 0.971.405.000) can be mixed in accordance with the manufacturer's instructions to neutralise this aftertaste.



### Note:

The fresh water tank is located in the luggage compartment in front of the lavatory, and in the right-hand luggage compartment to the rear of the driven axle on earlier bus models.



### Note:

Waste water from the kitchenette flows into the lavatory's holding tank.

### Filling the fresh water tank outside the bus

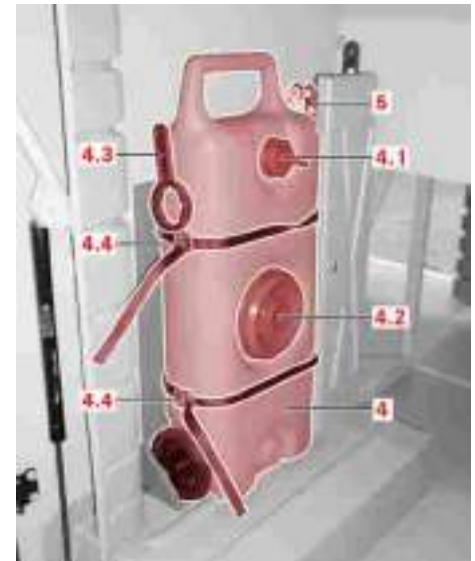

M86\_00-0142-02

- ▶ Disconnect quick-release coupling (5) from fresh water tank (4).

### Checking and cleaning the fresh water filter

- ▶ Release tensioning straps (4.4). Remove fresh water tank (4).
- ▶ Fill fresh water tank (4) with pure drinking water via cap (4.2). Close cap (4.2) firm and tight.
- ▶ Fit fresh water tank (4) into the bus and secure using tensioning straps (4.4).
- ▶ Connect quick-release coupling (5) to fresh water tank (4).

#### Checking and cleaning the fresh water filter

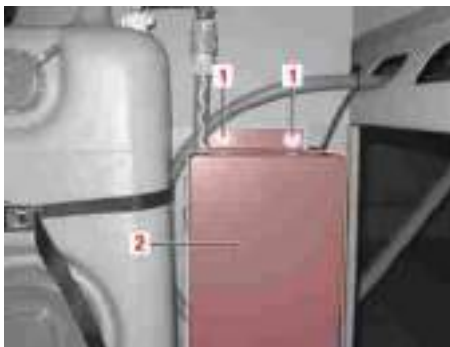

M86\_00-0376-71

- ▶ The fresh water filter is located behind cover (2). Unscrew knurled screws (1) to permit removal of the cover.

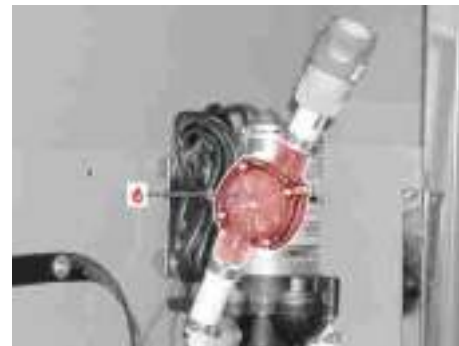

M86\_00-0143-01

- ▶ Check fresh water filter (6) for clogging at regular intervals (depending on the water quality) and clean it if necessary.



#### Note:

The fresh water filter is located between the fresh water tank and the fresh water pump.

## Drawing water from the water tap

### Drawing water from the water tap

- ▶ Galley switched on
- ▶ Fresh water tank filled and connected



M86\_00-0144-02

- ▶ Press button (6) to draw cold water from tap (8).
- Cold water continues to flow while button (6) is pressed.
- ▶ Press button (7) to draw hot water from tap (8).



### **Danger.**

Outflow of hot water - danger of scalding.

Hot water continues to flow while button (7) is pressed.



### **Note:**

No hot water can be drawn unless the boiler is in operation. It takes approximately 20 minutes for the water to heat up to a set temperature of 80 °C.



### **Note:**

Pressing both buttons (6) and (7) draws a mixture of hot and cold water.

### Switching on the boiler

#### Switching on the boiler

- ▶ Galley switched on
- ▶ Fresh water tank filled and connected



#### Caution:

There is a risk of overheating and thermal damage if the boiler is operated with no water. Never operate the boiler without water.

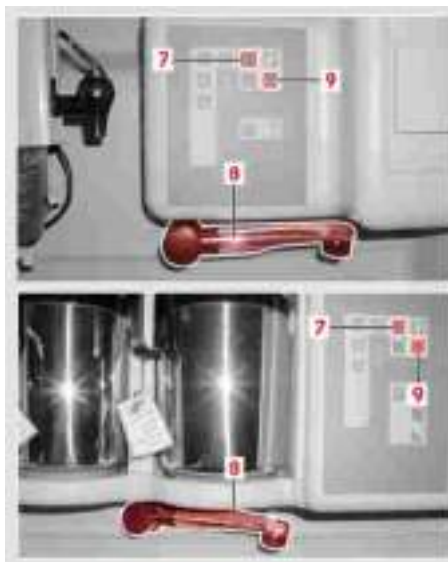

M86\_00-0145-02

- ▶ Before you switch on the boiler, press and hold button (7) until water flows out of tap (5) in order to make sure that the boiler contains water.

The boiler has been filled with water and bled.

- ▶ Press button (9) to switch on the boiler.

The LED in button (9) lights up and the water is heated.



#### Note:

Pressing button (9) again switches off the boiler. The LED goes out.

The boiler heats up the water and automatically switches off when the temperature set at the thermostat has been reached. The LED goes out.



#### Note:

The boiler has a capacity of approximately 5 litres and it takes approximately 20 minutes for the water to heat up to a set temperature of 80 °C.

### Setting the thermostat

- ▶ Remove the control panel by loosening the four crosshead screws under the film.



#### Note:

The boiler thermostat is located behind the removable control panel.

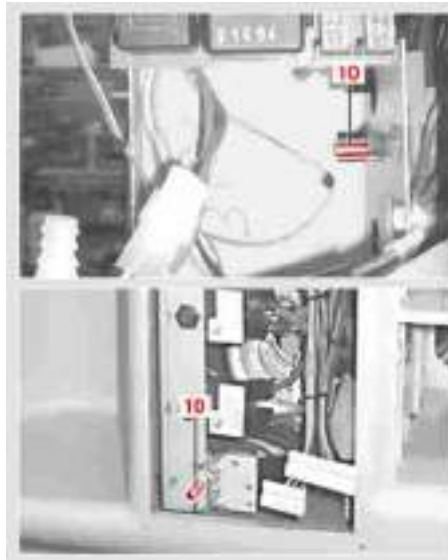

M86\_00-0146-02

- ▶ Set thermostat (10).



#### Note:

To set a lower temperature for the boiler, turn thermostat (10) anti-clockwise.



#### Note:

To set a higher temperature for the boiler, turn thermostat (10) clockwise.

- ▶ Move the control panel into position and secure using the four crosshead screws.

## Descaling the boiler

### Descaling the boiler

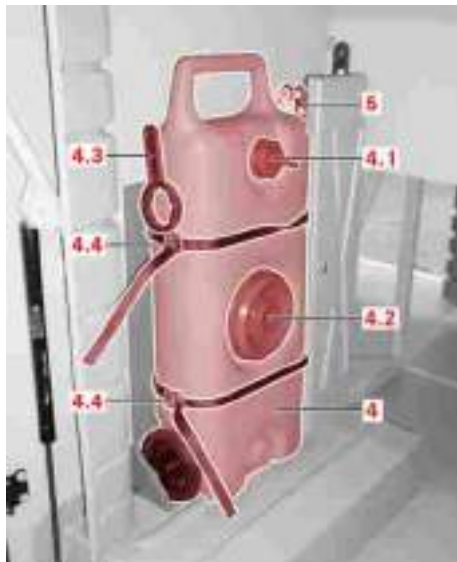

M86\_00-0142-02

- ▶ Disconnect the hose at quick-release coupling (5).

#### **i** Note:

How frequently the galley should be descaled depends on the water quality but the boiler should be descaled immediately if there is a noticeable increase in the length of the heating phase. It is advisable to descale the boiler twice a year.

- ▶ Hold the hose in a container of descaler (at least 10 litres).

#### **i** Note:

Use only descalers that are suitable for domestic appliances. The descaler must be non-aggressive to plastics and aluminium. Observe the information provided by the manufacturer.

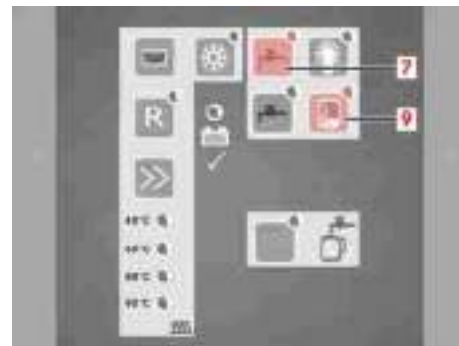

M86\_00-0147-01

- ▶ Press button (7) until descaler flows out of the tap.

The boiler has been filled with descaler.

- ▶ Press button (9) to switch on the boiler.

The LED in button (9) lights up and the water containing descaler is heated.

- ▶ Wait until the LED in the boiler goes out.  
The contents of the boiler have been heated.



### Note:

The boiler has a capacity of approximately 5 litres and it takes approximately 20 minutes for the water to heat up to a set temperature of 80 °C.

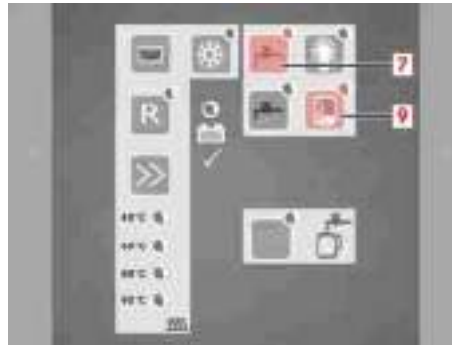

M86\_00-0147-01

- ▶ Press button (7) to drain the water and descaler.

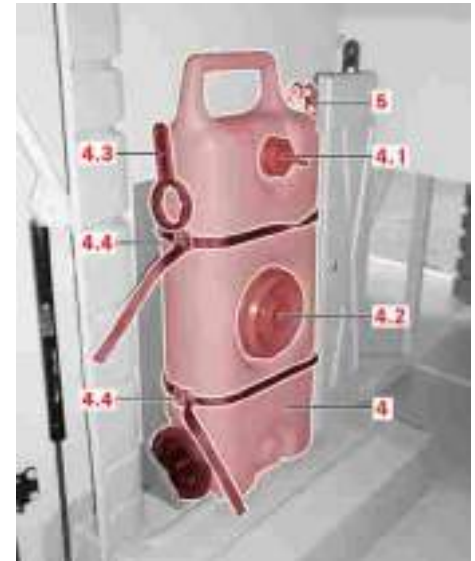

M86\_00-0142-02

- ▶ Connect the hose to fresh water tank (4).

### Switching on the sausage heater

- ▶ Flush the boiler with plenty of fresh water. To do this, fill the boiler with fresh water, heat the water and drain it.



#### Note:

Repeat the last step until the water no longer tastes or smells of descaler or vinegar.

### Switching on the sausage heater

- ▶ Galley switched on
- ▶ Fresh water tank filled and connected



#### Danger.

There is a risk of scalding when using the sausage heater. Hot steam can rise, which may cause serious burns to the face, arms and hands. Keep at a safe distance, and remove hot sausages using only heat-resistant kitchen utensils.



#### Note:

The length of the heating phase depends on the amount of water, the number of sausages and the temperature of the water used to fill the boiler.



#### Note:

The sausage heater has a capacity of 8.5 litres.



#### Note:

Waste water from the galley flows into the lavatory's holding tank.



## Switching on the sausage heater

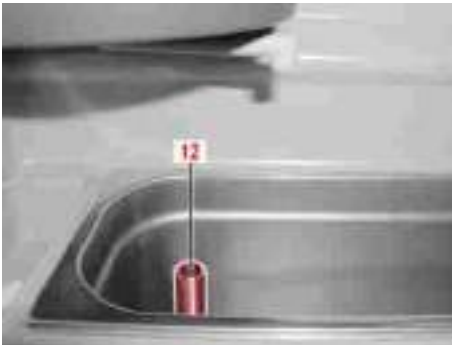

M86\_00-0149-01

- ▶ Insert overflow pipe (12) into the discharge hole, ensuring leak-tightness.

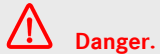

**Danger.**

Never use the sausage heater without water.



**Note:**

Excess water may run out via overflow pipe (12).

- ▶ Fill the sausage heater tank half full (approximately 2–3 litres) with cold or hot water.
- ▶ Add the sausages to the sausage heater tank and replace the lid on the sausage heater tank.



**Note:**

When adding sausages, there is a risk of hot water splashing and causing burns to the face, arms and hands. Add the sausages to the water carefully and keep a safe distance.

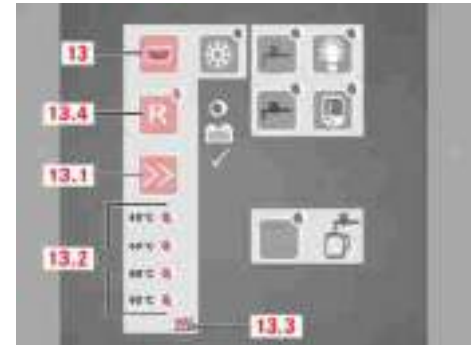

M86\_00-0165-01

- ▶ Switch on the sausage heater using button (13) on the control panel.

The LED in button (13) lights up.



**Note:**

Pressing button (13) again switches off the sausage heater. The LED goes out.

- ▶ Press button (13.1) repeatedly until the desired temperature is set.

### Switching on the sausage heater



#### Note:

It is possible to set a temperature of 40, 60, 80 or 95 °C. LED (13.2) indicates the set temperature.



#### Note:

LED (13.2) flashes while the sausage heater is heating and lights up when the set temperature has been reached.

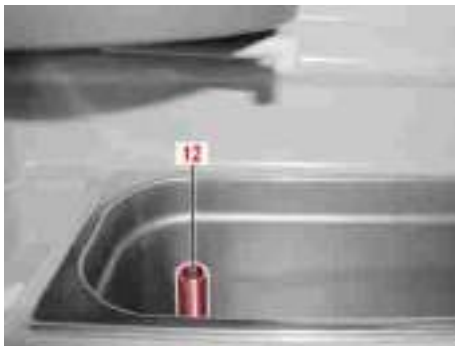

M86\_00-0149-01

- ▶ At the end of the heating phase, remove the lid.



#### Danger.

The sausage heater is hot and generates steam - risk of scalding. Do not remove overflow pipe (12) until the water in the tank has cooled sufficiently that there is no longer a risk of scalding.

- ▶ Take out the sausages using tongs or a suitable heat-resistant kitchen utensil.

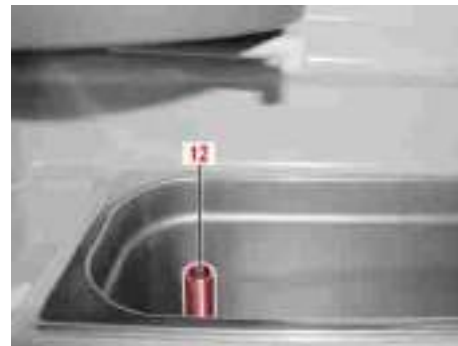

M86\_00-0149-01

- ▶ The water in the sausage heater tank can be drained as soon as the water has been allowed to cool down. To do this, remove overflow pipe (12) from the discharge hole.

## Cleaning the sausage heater

## Cleaning the sausage heater

- ▶ After use, clean the sausage heater tank, the lid and the overflow pipe with warm water and a commercially available washing up liquid. Use a soft sponge without a scourer or similar abrasive product. Rinse with clean water and wipe the sausage heater tank dry to avoid scaling. Clean the overflow pipe with bottle cleaner at regular intervals.

**Note:**

Clean the sausage heater tank with a commercially available stainless steel cleaner at regular intervals.

## Descaling the sausage heater

- ▶ Fill the sausage heater tank 2 cm high with descaler.
- ▶ Leave the descaler to work (observe the information issued by the manufacturer).

**Note:**

For heavy scaling, it is possible to operate the sausage heater containing descaler for approximately 30 minutes at 80 °C.

- ▶ Drain the boiler after the descaler reaction time and rinse well with clean water. Wipe the sausage heater tank dry.

## Switching on the 2-carafe filter system

- ▶ Galley switched on
- ▶ Fresh water tank filled and connected

**Caution:**

Running programs cannot be interrupted. If there is a power failure, it will be necessary to restart the program. If the carafes contain coffee from a previous program, they must be drained first to avoid the risk of overflowing.

**Caution:**

To avoid the risk of overflowing, make sure that the carafes are empty before the brewing process begins.

### Brewing 1/2 a carafe of coffee (10 cups of coffee)



#### Note:

The coffee filter must equate to size 1 x 6 (commercially available). Add the amount of coffee powder according to taste (e.g. 1 teaspoon per cup).

- ▶ The 2-carafe filter system is able to fill two carafes with a capacity of 2 litres. This is sufficient to pour 40 100 ml cups of coffee. It is possible to brew 1/2 a carafe, 1 carafe or 2 carafes of coffee.

### Brewing 1/2 a carafe of coffee (10 cups of coffee)



M86\_00-0151-01

- ▶ Remove left-hand filter (25). Insert filter paper and add as much coffee powder as required.



#### Note:

Add coffee powder to taste (e.g. 1 teaspoon per cup, which corresponds to 10 teaspoons for half a carafe of coffee).

- ▶ Slide left-hand filter (25) back into position.
- ▶ Place an empty carafe (26) under left-hand filter (25).



M86\_00-0153-01

- ▶ Press button (30) on the control panel.

The LED in button (30) lights up. The brewing process begins.

- ▶ An electronic signal sounds when brewing has finished.

The LED in button (30) goes out.

## Brewing 1 carafe of coffee (20 cups of coffee)

### Brewing 1 carafe of coffee (20 cups of coffee)



M86\_00-0151-01

- ▶ Remove left-hand filter (25). Insert right filter paper and add as much coffee powder as required.



#### Note:

Add coffee powder to taste (e.g. 1 teaspoon per cup, which corresponds to 20 teaspoons for one carafe of coffee).

- ▶ Slide left-hand filter (25) back into position.
- ▶ Place an empty carafe (26) under left-hand filter (25).



M86\_00-0154-01

- ▶ Press button (31) on the control panel.

The LED in button (31) lights up. The brewing process begins.

- ▶ An electronic signal sounds when brewing has finished.

The LED in button (31) goes out.

### Brewing 2 carafes of coffee (40 cups of coffee)



M86\_00-0152-01

- ▶ Remove left-hand filter (25) and right-hand filter (27). Insert filter paper and add as much coffee powder as required.



#### Note:

Add coffee powder to taste (e.g. 1 teaspoon per cup, which corresponds to 20 teaspoons for one carafe of coffee).

### Manual operation of the 2-carafe filter system

- ▶ Slide left-hand filter (25) and right-hand filter (27) back into position.
- ▶ Place two empty carafes (26) and (28) under left-hand filter (25) and right-hand filter (27) respectively.
- ▶ An electronic signal sounds when brewing has finished.  
The LED in button (32) goes out.

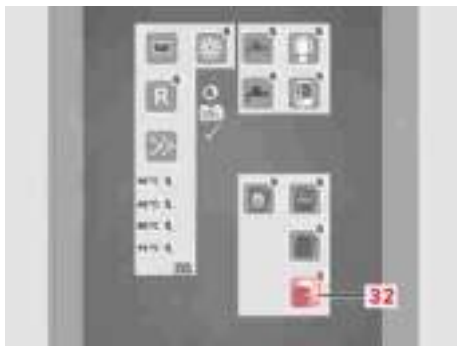

M86\_00-0155-01

- ▶ Press button (32) on the control panel.  
The LED in button (32) lights up. The brewing process begins.

### Manual operation of the 2-carafe filter system



#### Note:

Button (33) is not required for normal operation. It can be used to drain off any residual water in the coffee machine water tank.



M86\_00-0151-01

- ▶ Place an empty carafe on the left-hand side.

## Descaling the coffee machine



M86\_00-0156-01

- ▶ Press button (33).

The water in the 2-carafe filter system is boiled out.

The water in the 2-carafe filter system is completely drained.

### Descaling the coffee machine

#### **i** Note:

How frequently the galley should be descaled depends on the water quality but the coffee machine should be descaled immediately if performance deteriorates or if the openings in the filter begin to scale up.

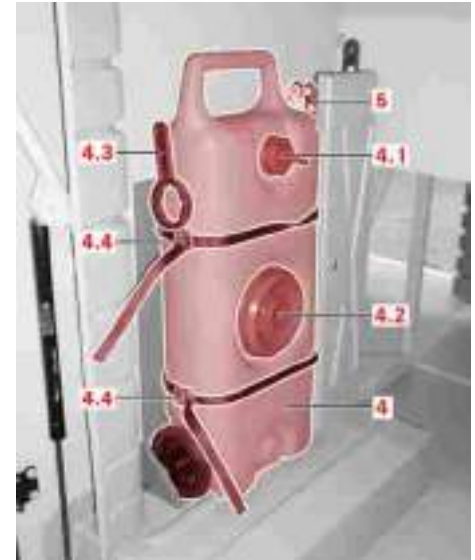

M86\_00-0142-02

- ▶ Disconnect the hose at quick-release coupling (5).

### Winter operation

- ▶ Hold hose in a container of descaler (at least 10 litres).



#### Note:

Use only descalers that are suitable for domestic appliances. The descaler must not attack plastics and aluminium.

- ▶ Operate the 40-cup coffee machine without the filter holder and with the tank full or operate the 2-carafe filter system with two carafes.



#### Note:

Clean the filter holder of the 40-cup coffee machine using only a commercially available washing up liquid and a brush.

- ▶ Connect the hose to fresh water tank (4).

- ▶ Flush with fresh water. To do this, brew several carafes without coffee.



#### Note:

Repeat the last step until the water no longer tastes or smells of descaler or vinegar.

### Winter operation

- ▶ Galley switched on
- ▶ Over winter, drain the fresh water tank, water lines, boiler, coffee machines and siphon.



#### Note:

To prevent damage to water-carrying installations, these must be completely drained before the first frost.



## Draining the fresh water tank

### Draining the fresh water tank

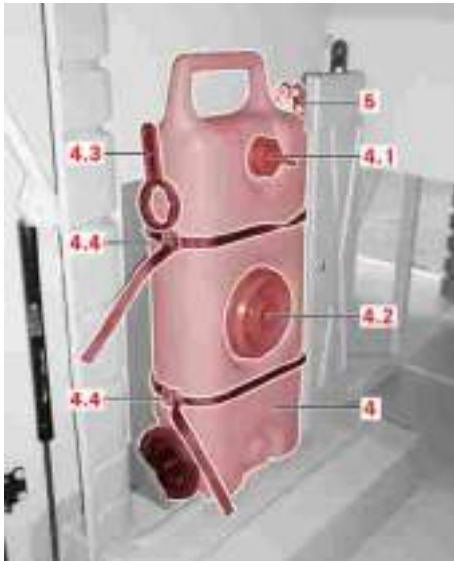

M86\_00-0142-02

- ▶ Disconnect quick-release coupling (5) from fresh water tank (4).

- ▶ Release both tensioning straps (4.4).
- ▶ Remove fresh water tank (4) from the bus and open cap (4.1) to completely drain the water.

#### **i** Note:

Use spanner (4.3) if the caps are difficult to turn.

- ▶ Close cap (4.1) firm and tight. Fit fresh water tank (4) into the bus and secure using tensioning straps (4.4). Connect quick-release coupling (5) to fresh water tank (4).

The fresh water tank is completely drained.

### Draining the water lines

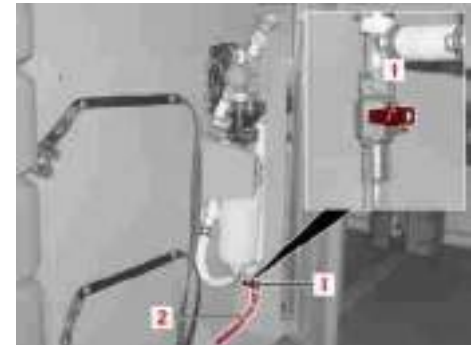

M86\_00-0305-71

- ▶ To drain off the majority of the water, route hose (2) to the outside of the bus and open tap (1).

#### **i** Note:

The tap is located in the luggage compartment next to the fresh water tank or below the water pump.

### Draining the boiler

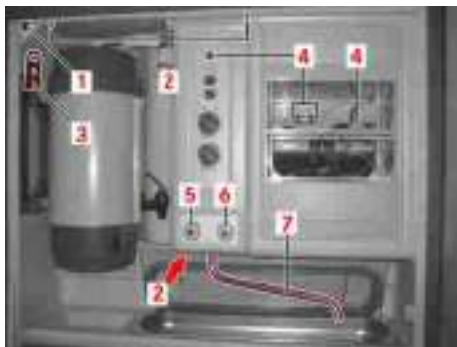

M86\_00-0377-71

- ▶ To drain off the remaining water, open cold water tap (5) and hot water tap (6) and allow the boiler to drain empty.

The water lines are completely drained.

#### Draining the boiler



#### Caution:

There is a risk of overheating if the boiler is operated with no water. Switch off the boiler before draining it.



#### Note:

The drain plug is located on the bottom left behind the folding cover of the galley.



M86\_00-0306-71

- ▶ Pull out hose (36) on the left-hand side behind the folding cover.
- ▶ Position a heat-resistant container (minimum capacity of 5 litres) under the end of the hose sealed with a red or black drain plug (36.1).



#### Danger.

Hot water may flow out when the boiler is drained. Do not allow your hands or arms to come into contact with the water.

## Draining the 2-carafe filter system

- ▶ Open hose clamp (36.2), remove red or black drain plug (36.1) and drain all the water from the boiler into the container underneath.
- ▶ Seal hose (36) with the red or black drain plug (36.1). Secure drain plug (36.1) firmly in place using hose clamp (36.2). Slide hose (36) back into the galley.

The boiler is completely drained.

### Draining the 2-carafe filter system



#### Note:

The 2-carafe filter system is automatically drained after every brewing process.

- ▶ Proceed as follows if you wish to make sure that there is no more water in the 2-carafe filter system:



M86\_00-0151-01

- ▶ Place an empty carafe (26) on the left-hand side.



M86\_00-0156-01

- ▶ Press button (33).

The water in the coffee machine tank is boiled out.

The 2-carafe filter system is drained.

### Draining the siphon

#### Draining the siphon



#### Note:

The siphon of the galley waste water drain is located in the 2nd step in doorway II.



M86\_00-0160-01

- ▶ Disassemble and empty the siphon (39) (odour trap) for the kitchenette waste water drain at union nuts (39.1).

- ▶ Fill the siphon with windscreen anti-freeze mat. no. A 001 986 45 71 11 (down to  $-30\text{ }^{\circ}\text{C}$ ) and then reassemble it.

#### Replacing fuses



#### Danger. Risk of fire.

Do not use fuses with a higher than specified amperage.

The result would be damage to the electrical system or even a fire in the cables.

- Always use fuses of the specified amperage and never attempt to bridge or rewire fuses.
- Fuses should be replaced only when the cause of malfunction has been rectified.



#### Danger.

Do not replace fuses unless the power has been switched off.

**Note:**

This description is based on the standard assignment of fuses in the bus. Bus-specific assignment may differ from bus to bus. Not all fuse slots are necessarily occupied in every bus. Furthermore, fuses may occupy unassigned slots because they are protecting special customer options or retrofitted equipment, for example.



M54.00-1931-71

- ▶ Switch off the galley at master switch (1).  
The LED goes out.
- ▶ Switch off the engine.



M54.00-2004-71

- ▶ Switch battery isolating switch (01S01) to OFF.

## Replacing fuses

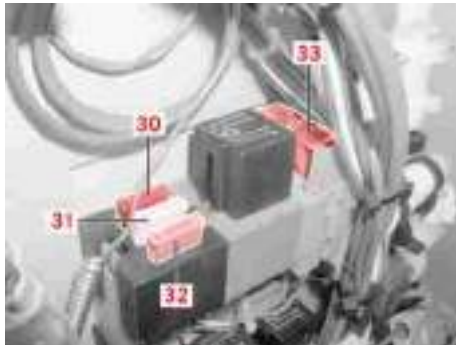

M86\_00-0180-71

- ▶ Exchange the defective galley fuse.

**i** **Note:**

The fuses for the galley are located on the back of the galley behind the mirror in the lavatory. The mirror can be removed (screws, mirror bracket or Velcro fasteners).

**i** **Note:**

30 Water pump (10 A)

**i** **Note:**

31 Sausage heater (25 A)

**i** **Note:**

32 Electronics (5 A)

**i** **Note:**

33 Coffee machine (40 A)



M86\_00-0181-71

- ▶ Exchange the defective boiler fuse.

**i** **Note:**

The fuses for the boiler are located under the plastic cover. To remove the plastic cover, undo the two screws in the cup recesses and the screw in the carafe recess. Lift the back of the plastic cover approximately 5 cm and slide it forwards to free the plastic cover from the pipe of the cup dispenser.

**Note:**

34 Terminal 15 (5 A)

**Note:**

35 D+ (engine) (5 A)

**Note:**

36 Water pump (10 A)

**Note:**

37 Boiler (50 A)

**Malfunctions**

- ▶ This section describes malfunctions that you can rectify yourself.

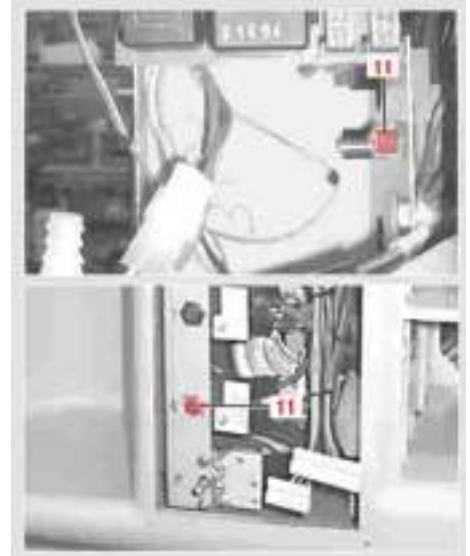
**Restoring boiler operation following a malfunction**

M86\_00-0148-02

### Restoring boiler operation following a malfunction

- ▶ The overheating protection is triggered if the boiler is operated with no water.



#### Note:

Fill the boiler with water to rectify the malfunction. Reactivate the overheating protection by pressing button (11) behind the control panel.

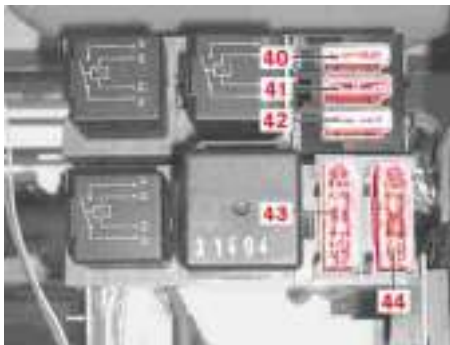

M86\_00-0162-01

- ▶ The boiler does not heat up.



#### Note:

Replace fuse (44) to rectify the malfunction.

- ▶ Insufficient hot water flow or excessive heating time.



#### Note:

Symptom of scaling, descale the boiler.

- ▶ Water flows out of the tap when the boiler is heating.



#### Note:

No malfunction, because water expands during the heating process.



## Using the sausage heater again after a malfunction

### Using the sausage heater again after a malfunction

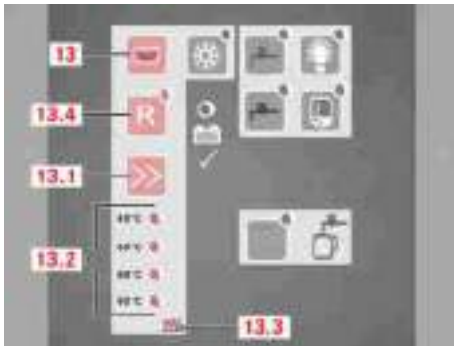

M86\_00-0165-01

- ▶ The overheating protection is triggered if the sausage heater is operated with no water. The red LED in button (13.4) lights up.

#### **i** Note:

Fill the sausage heater with water to rectify the malfunction. Reactivate the overheating protection by pressing button (13.4) on the control panel.

### Using the 2-carafe filter system again after a malfunction

- ▶ A continuous tone indicates that the fresh water tank is empty.

#### **i** Note:

Fill the fresh water tank. Press any button on the control panel of the 2-carafe filter system. The 2-carafe filter system resumes the program from the point at which it was interrupted.



M86\_00-0157-01

- ▶ Overheating protection triggered.

#### **i** Note:

To reactivate the 2-carafe filter system, press the overheat protection switch for left-hand carafe (34) or right-hand carafe (35) behind the control panel.

### Other malfunctions

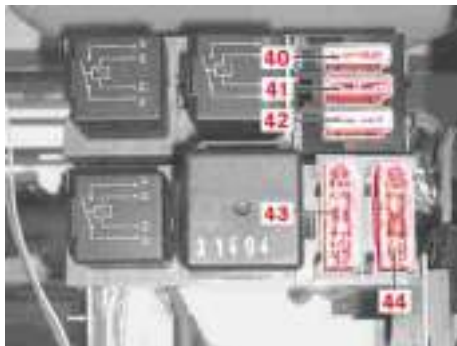

M86\_00-0162-01

- ▶ 2-carafe filter system fills with water but does not brew.



#### Note:

Replace fuse (43) to rectify the malfunction.

### Other malfunctions

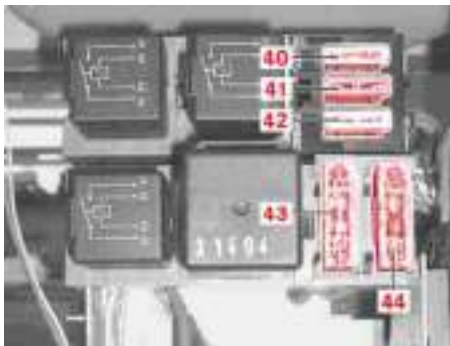

M86\_00-0162-01

- ▶ The control panel is not working.



#### Note:

Either the fuse or the control panel is defective. Replace fuse (42) or have the control panel repaired by the after-sales service.

- ▶ Galley light does not switch on.



#### Note:

Change bulb (24 V/5 W) or replace fuse (42).



#### Note:

In the case of on-board kitchenettes with 40-cup coffee machine, the lighting features LED technology.

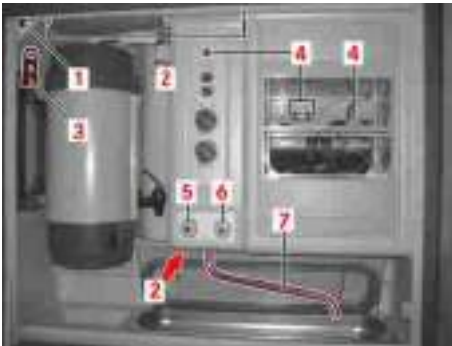

M86\_00-0377-71

- ▶ No water or irregular flow.

**i** **Note:**

Fill the fresh water tank with water. Or replace fuse (41). Or have the water pump replaced by the after-sales service.

**i** **Note:**

In the case of on-board kitchenettes with 40-cup coffee machine, replace defective fuse (4).

### Switching off the kitchenette

**i** **Note:**

All appliances must be switched off before the kitchenette can be switched off.

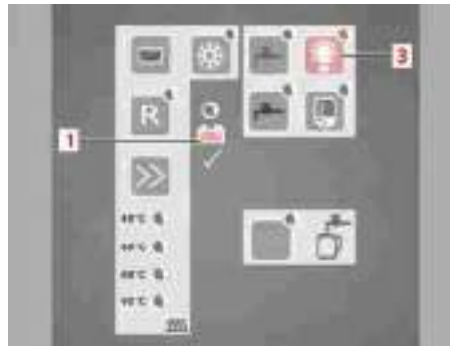

M86\_00-0141-01

- ▶ Switch off the kitchenette lighting using button (3) on the control panel.
- ▶ Fold the upper folding cover upwards through 90° and press against the guide rails. Pull the entire folding cover upwards by the upper folding cover.

The kitchenette is locked away.



M54.00-1931-71

- ▶ Press kitchenette master switch (1).  
The LED goes out.  
The kitchenette is switched off.



|  |     |
|--|-----|
| Enabling the lavatory .....  | 426 |
| Switchover between water (WC) and chemical (CC) operation (option) ..... | 428 |
| Flushing the WC .....  | 429 |
| Drawing water at the handwash basin .....                                | 430 |
| Filling the soap dispenser .....   | 430 |
| Adding paper hand towels .....   | 431 |
| Adding toilet paper .....  | 431 |
| Opening the basin undercabinet .....                                     | 431 |
| Changing waste bags .....  | 432 |
| Filling the fresh water storage tank .....                               | 432 |
| Emptying the fresh water storage tank .....                              | 433 |
| Emptying the holding tank .....  | 434 |
| Winter operation .....   | 435 |
| Greasing the impeller of the CC pump .....                               | 436 |

## Enabling the lavatory

### Enabling the lavatory



M54.00-1932-71

- ▶ To enable the lavatory, press switch (1) underneath the driver's window with the ignition starter switch ON.

### **i** Note:

The LED in the switch lights up and the lavatory cabin lighting switches on. Option: The lavatory cabin door unlocks automatically whenever switch (1) is pressed and locks again when the switch is switched off.

### **i** Note:

The extractor fan in the lavatory cabin operates continuously while the engine is running.

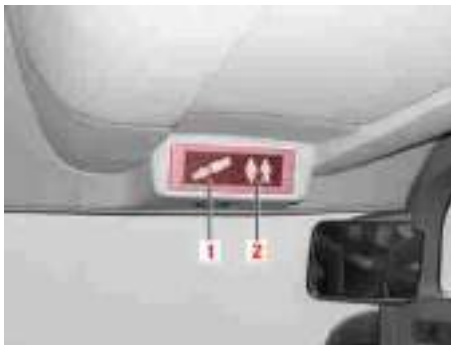

M54\_00-0978-01

Whenever the lavatory is locked from the inside, the extractor fans for the holding tank and lavatory cabin switch on and “WC occupied” symbol (2) appears in the passenger compartment display.



M86.00-0428-717

- ▶ Whenever the ignition starter switch is switched on, the smoke detector in the WC is also primed. LED (1) lights up green.

### **i** Note:

If LED (1) lights up green, the smoke detector is operating normally. In the event of slight contamination, LED (1) remains green but flashes yellow every so often. Heavy contamination of the detector is indicated by the LED flashing green and yellow alternately. Have the smoke detector exchanged by an OMNIplus Service

Partner. In the event of a malfunction, LED (1) lights up yellow.



**Danger.**

Whenever smoke is detected, LED (1) lights up red and a red alert is displayed on the display screen in the driver's area in conjunction with this icon.



M86.00-0432-71

- ▶ In an emergency, press red pushbutton (1) once.



M54.00-2011-71

A yellow alert appears on the display screen in the driver's area: WC lavatory emergency call



**Note:**

This yellow alert is cleared if pushbutton (1) is pressed again.

## Switchover between water (WC) and chemical (CC) operation (option)



M86\_00-0028-01

- ▶ Opening a mechanically locked door

### **i** Note:

If lock (2) on the lavatory cabin door has been locked mechanically, it can be unlocked by means of a suitable coin or a screwdriver.

## Switchover between water (WC) and chemical (CC) operation (option)

### **i** Note:

With this equipment version, the lavatory can be operated either as a water-flushed toilet or as a chemical toilet.

### **i** Note:

If the lavatory is to be used as a chemical toilet, the holding tank must be filled with a certain amount of sanitary chemical after each time it has been emptied. To do this, pour approximately 20 litres of water into the lavatory bowl. Then add the sanitary chemical in the mixing ratio specified.



### Caution:

Whenever you enable the lavatory for chemical operation, check that the CC pump runs correctly (briefly press the flush button). If the pump fails to run, it will need to be greased. –refer to section: “Greasing the impeller of the CC pump”





M86\_00-0273-71

- ▶ Turn switch (1) to the left to switch over to chemical operation.

**Note:**

The switch is located behind the service cover to the front of the centre right door (door 2).

The lavatory will now be flushed with the sanitary chemical from the holding tank.

**Caution:**

Dry running would cause damage to the chemical fluid pump (impeller pump). For this reason, always ensure that there is a sufficient level of sanitary chemical fluid in the system.

- ▶ Turn switch (1) back to the right to switch back to water-flushing operation.

The lavatory will then be flushed with water from the fresh water tank.

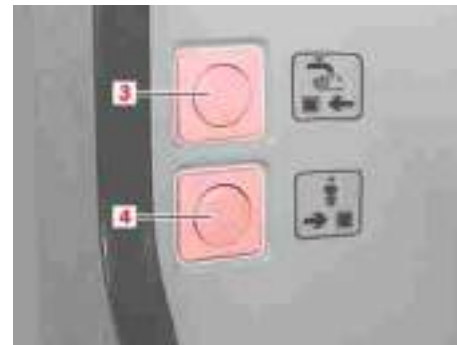
**Flushing the WC**

M86\_00-0029-01

- ▶ The flushing process is triggered by pressing WC flush pushbutton (4).

**Note:**

The water pump is operated for approximately 5 seconds; at the same time, the gate valve to the solid waste container is opened.

## Drawing water at the handwash basin

### Drawing water at the handwash basin

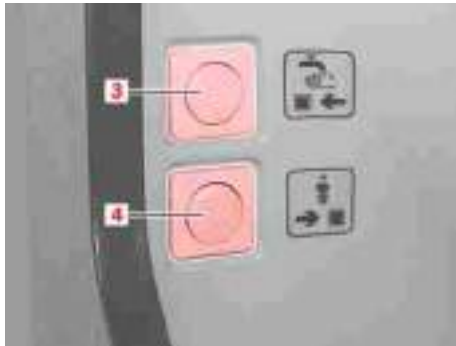

M86\_00-0029-01

- ▶ The water pump runs for approximately 3 seconds when handwash basin water supply pushbutton (5) is pressed and water flows from the tap.



#### **Danger.**

The water from the tap is not of drinking water quality.



#### **Note:**

The waste water reaches the solid waste container via a system of hoses.

### Filling the soap dispenser

- ▶ Open the cover by raising it slightly and pulling it towards you.



#### **Note:**

Remove the red cap from a new bottle. Place the new bottle in position with the writing facing forwards and push it gently into place. Pull the lever firmly to the right (closed position). Close the soap dispenser.

## Adding paper hand towels

## Adding paper hand towels

- ▶ Open the cover by raising it slightly and pulling it towards you.

**Note:**

Insert the towels as shown on the inside of the dispenser.

## Adding toilet paper

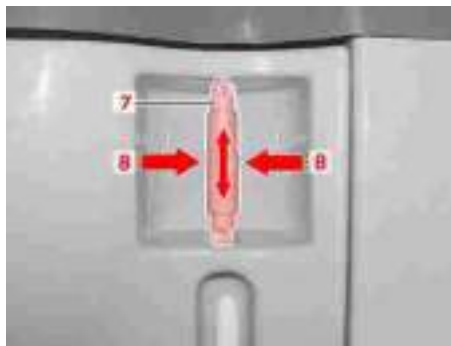

M86\_00-0032-01

- ▶ Squeeze toilet paper holder (7) to remove and replace it.

## Opening the basin undercabinet

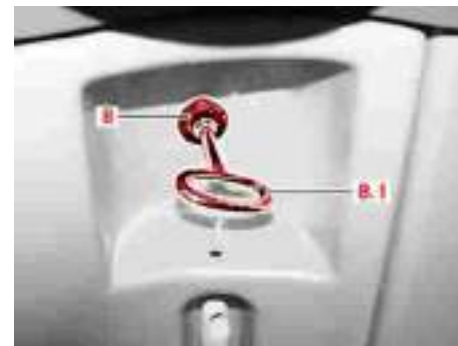

M86\_00-0033-01

- ▶ Remove toilet paper holder (7), open lock (8) using the supplied square spanner (8.1) and fold open the basin undercabinet.

## Changing waste bags

### Changing waste bags



M86\_00-0034-01

- ▶ Folding open the basin undercabinet makes it possible to secure a waste bag to the bottom of the waste chute by means of an elastic strap.



#### Note:

Waste chute (9) on the top of the wash-basin is for disposing of used paper towels.

### Filling the fresh water storage tank



M86\_00-0036-01

- ▶ Open the right service cover to the front of the centre right door. To fill the fresh water storage tank, connect a supply line between coupling (10.1) and an external water supply and open shut-off valve (10.2).



#### Danger.

Do not allow the filling process to continue unsupervised. If the water fill pressure is too high or if the overflow is blocked by a foreign object, there is a risk of the tank expanding and damaging the overlying floor.



M86\_00-0037-01

- ▶ Ending the filling operation

## Emptying the fresh water storage tank

**Note:**

Water escapes from overflow (11) under the floor of the bus when the container is completely filled. Close the tap immediately, remove the hose.

**Danger.**

Do not add antifreeze to the fresh water storage tank - risk of poisoning.

**Emptying the fresh water storage tank**

M86\_00-0036-01

- ▶ To empty the fresh water storage tank, take the filler hose from the holder and open shut-off valve (10.2) on the coupling (10.1). Let the water run out.

**Note:**

The fresh water storage tank must be emptied if the bus or the lavatory is to remain out of service for some time.

**Danger.**

Observe the notes on winter operation to prevent damage to water-carrying installations during freezing weather conditions.

## Emptying the holding tank

### Emptying the holding tank



M86\_00-0038-01

- ▶ To empty the holding tank, it is necessary to park the bus such that the sewage discharge opening (12) is positioned over a suitable sewage collection point.



#### Note:

Switch on the ignition and enable the lavatory using the switch on the instrument panel.



M86.30-0058-71

- ▶ Turn compressed-air tap (1) clockwise to the “AUF” (OPEN) position. Press auxiliary pushbutton (2).



#### Note:

Compressed-air tap (1) is located behind the WC service cover.



### Environmental protection

Dispose of sewage in an environmentally responsible manner. The rules and regulations of the country in which the vehicle is operated must be observed.

The drainage valve on the holding tank is opened.

After it has emptied, close compressed-air tap (1). Then press auxiliary pushbutton (2).



#### Note:

The waste slide valve closes.

## Winter operation

**Note:**

Empty the whole system if there is a risk of frost.

- ▶ Empty the fresh water storage tank.



M86\_00-0040-01

- ▶ Disconnect the lines (15.1) to the pumps (15) and let them run empty.

**Note:**

Operate the pumps using the pushbuttons (3 or 4) until all of the water has run out. Reconnect the lines.

- ▶ Empty the solid waste container.

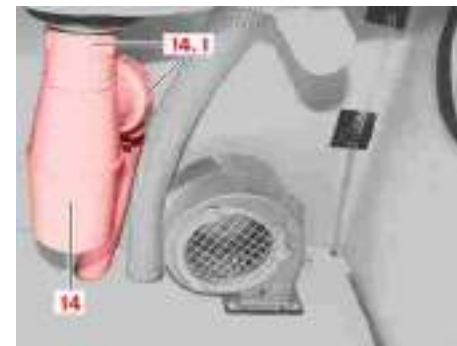

M86\_00-0039-01

- ▶ Unscrew the siphon (odour trap) (14) in the basin undercabinet from the handwash basin at the union nuts (14.1), empty and fill with antifreeze mat. no. A 001 986 45 71 11. Re-assemble the siphon (14).

## Greasing the impeller of the CC pump

### Greasing the impeller of the CC pump



#### Note:

If the CC has been out of operation for a lengthy period, the impeller could seize and the CC pump would fail.



#### Note:

If the CC has been out of operation for a lengthy period, e.g. after the summer season during which only WC operation was active, we recommend that the impeller of the CC pump be greased before switching from WC to CC operation.

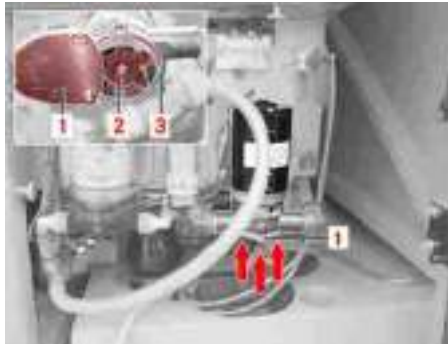

M86\_00-0355-71

- ▶ Undo the securing screws (arrowed) and remove cover (1) downwards.



#### Danger.

Residues may be expelled from the CC pump as the cover is opened. The residues are caustic and must not be allowed to come into contact with skin, eyes or clothing. Rinse affected areas immediately and thoroughly with clean water. Seek medical attention if necessary. Wear protective equipment (gloves, goggles, etc.).



#### Danger.

Observe the instructions issued by the manufacturer when handling sanitary fluids.

- ▶ To make the seized impeller easier to move, coat the outer sides of impeller (2) with approximately 5 - 10 g Vaseline or multipurpose grease.
- ▶ To distribute the grease evenly, turn impeller (2) several times in the direction of rotation.
- ▶ Seal (3) should also be coated with grease.
- ▶ Resecure cover (1).



|   |            |
|---|------------|
| <b>Overview of the operating, function and malfunction display screen .....</b> | <b>442</b> |
| <b>Electric fuel pump (option) .....</b>  | <b>448</b> |
| <b>Engine oil level display .....</b>   | <b>448</b> |
| <b>Oil level alerts .....</b>   | <b>449</b> |
| <b>Oil level information .....</b>  | <b>450</b> |
| <b>Checking the engine oil level with the dipstick (option) .....</b>           | <b>452</b> |
| <b>Safety precautions for work carried out in the engine compartment .....</b>  | <b>453</b> |
| <b>Removing the drive belts (OM 470) .....</b>                                  | <b>453</b> |
| <b>Fitting the drive belts (OM 470) .....</b>                                   | <b>455</b> |
| <b>Removing the drive belts (OM 471) .....</b>                                  | <b>459</b> |
| <b>Fitting the drive belts (OM 471) .....</b>                                   | <b>463</b> |
| <b>Checking the coolant level of the engine and heating system .....</b>        | <b>468</b> |
| <b>Tyres - operating safety and roadworthiness .....</b>                        | <b>469</b> |
| <b>Tyre pressure .....</b>  | <b>470</b> |
| <b>On-screen tyre pressure monitor .....</b>                                    | <b>470</b> |
| <b>Tyre tread .....</b>   | <b>472</b> |

### Table of contents

|  |            |
|--|------------|
| <b>Tyre condition</b> .....  | <b>472</b> |
| <b>Tyre age</b> .....  | <b>472</b> |
| <b>Invisible tyre damage</b> .....   | <b>473</b> |
| <b>Tyre load capacity, top speed of tyres and types of tyres</b> .....                 | <b>473</b> |
| <b>Retreaded tyres</b> .....   | <b>474</b> |
| <b>Tyre pressures table 295/80 R 22.5</b> .....  | <b>476</b> |
| <b>Safety measures to be taken in the event of a flat tyre or a wheel change</b> ..... | <b>477</b> |
| <b>Fitting snow chains</b> .....   | <b>478</b> |
| <b>Removing the spare wheel from the spare wheel cover</b> .....                       | <b>479</b> |
| <b>Positioning the jack</b> .....  | <b>480</b> |
| <b>Removing the wheel trims</b> .....  | <b>481</b> |
| <b>Removing the wheels</b> .....   | <b>482</b> |
| <b>Fitting the spare wheel</b> .....   | <b>487</b> |
| <b>Fitting the wheel trims</b> .....   | <b>489</b> |
| <b>Inflating tyres using the tyre inflator connection</b> .....                        | <b>490</b> |
| <b>Pneumatic system test ports under the driver's area</b> .....                       | <b>492</b> |

|   |            |
|---|------------|
| <b>Pneumatic test ports behind door 2</b> .....   | <b>494</b> |
| <b>Other pneumatic test ports</b> .....   | <b>496</b> |
| <b>Charging the compressed-air system of another bus</b> .....  | <b>497</b> |
| <b>Operating the bus stop brake emergency release switch</b> .....  | <b>499</b> |
| <b>Electrical system safety precautions</b> .....   | <b>499</b> |
| <b>Safety precautions for handling batteries</b> .....  | <b>500</b> |
| <b>Measures required for the prevention of damage to buses or components during electric welding work</b> ..... | <b>501</b> |
| <b>Electrical system (illustration shows TRAVEGO 2-axle model as an example)</b> .....                          | <b>504</b> |
| <b>Battery isolating switch (with switch-off authorisation LED)</b> .....                                       | <b>506</b> |
| <b>Driver's area interior switch panel</b> .....  | <b>508</b> |
| <b>Main switch panel (under the driver's area)</b> .....  | <b>510</b> |
| <b>Auxiliary switch panel</b> .....   | <b>512</b> |
| <b>Ceiling switch panel</b> .....   | <b>514</b> |
| <b>Electrical connection for the roof-mounted system (heating, ventilation, air-conditioning)</b> .....         | <b>516</b> |
| <b>Battery compartment</b> .....  | <b>518</b> |

**Table of contents**

|   |            |
|---|------------|
| <b>Notes on fuse assignments</b> .....  | <b>519</b> |
| <b>Fuse assignment for driver's area interior switch panel</b> .....  | <b>520</b> |
| <b>Fuse assignment for main switch panel (under the driver's area)</b> .....                                  | <b>522</b> |
| <b>Fuse assignment for auxiliary switch panel</b> .....   | <b>524</b> |
| <b>Power distribution board (PDB) fuse assignment on auxiliary switch panel</b> .....                         | <b>528</b> |
| <b>Fuse assignment for ceiling switch panel</b> .....   | <b>530</b> |
| <b>Fuse assignment for roof-mounted heating, ventilation and air-conditioning system (Spheros)</b> .....      | <b>532</b> |
| <b>Handling fuses</b> .....   | <b>533</b> |
| <b>Disconnecting vehicle batteries</b> .....  | <b>534</b> |
| <b>Recharging vehicle batteries</b> .....   | <b>536</b> |
| <b>Switching to the auxiliary batteries (starter batteries) (option)</b> .....                                | <b>537</b> |
| <b>Notes on jump-starting</b> .....   | <b>537</b> |
| <b>Jump-start procedure</b> .....   | <b>538</b> |
| <b>Activation and evaluation of the Integrated Diagnostics System (IDS)</b> .....                             | <b>539</b> |
| <b>Changing bulbs</b> .....   | <b>542</b> |
| <b>Adjusting the headlamps for driving on the left or right (only in buses with bi-xenon headlamps)</b> ..... | <b>547</b> |

|  |            |
|--|------------|
| <b>Removing the exterior mirror, fitting the emergency mirror (option) .....</b>               | <b>548</b> |
| <b>Maintenance tasks for the air-conditioning system in the bus (filter maintenance) .....</b> | <b>550</b> |
| <b>Scopes of maintenance for the air-conditioning system .....</b>                             | <b>551</b> |
| <b>Bleeding the coolant circuit for the heating system .....</b>                               | <b>555</b> |

### Overview of the operating, function and malfunction display screen

#### Overview of the operating, function and malfunction display screen



















M68.00-0547-71

Instrument cluster display screen (1) is a status indicator that displays operating, function and malfunction information (icons). Additionally, it can be used to view IDS (Integrated Diagnostics System) information.









| Symbol | Description |
|--------|-------------|
|--------|-------------|









|  |                          |
|--|--------------------------|
|  | Alternator 1 malfunction |
|--|--------------------------|









| Symbol  | Description                      |
|---|----------------------------------|
|  | Alternator 2 malfunction         |
|  | Alternator 3 malfunction         |
|  | No battery charge                |
|  | No battery charge (alternator 1) |
|  | No battery charge (alternator 2) |
|  | No battery charge (alternator 3) |
|  | Battery undervoltage             |
|  | Battery overvoltage              |

| Symbol  | Description                             |
|---|---|
|  | Air cleaner clogged                     |
|  | Exhaust gas cleaning malfunction        |
|  | Particulate filter                      |
|  | DPF regeneration                        |
|  | Cruise control                          |
|  | Variable speed limiter (TempoSet)       |
|  | Distance cruise control                 |
|  | Distance cruise control braking request |

























Overview of the operating, function and malfunction display screen

| Symbol  | Description                       |
|---|-----------------------------------|
|  | Active Brake Assist               |
|  | ABA distance warning, visual only |
|  | Transmission in neutral           |
|  | Reverse gear selected             |
|  | Automatic mode                    |
|  | Manual gearshift mode inhibited   |
|  | Transmission in teach-in mode     |
|  | Limit speed prewarning            |

| Symbol   | Description  |
|--|--|
|   | Ready to depart (in transmission shift system failsafe mode) |
|   | Clutch overload  |
|   | Continuous brake preselected                                 |
|   | Continuous brake in operation                                |
|   | No continuous brake torque                                   |
|   | Retarder via brake pedal OFF                                 |
|   | Incorrect use of continuous brake                            |
|  | ABS not available  |









| Symbol  | Description                  |
|---|------------------------------|
|  | Traction control             |
|  | ESP active                   |
|  | ESP off                      |
|  | Engine oil level too low     |
|  | Engine oil level too high    |
|  | Engine oil pressure too low  |
|  | Coolant level too low        |
|  | Coolant temperature too high |









### Overview of the operating, function and malfunction display screen

| Symbol   | Description  | Symbol  | Description  | Symbol  | Description                           |
|--|--|---|--|---|---------------------------------------|
|  | Engine power output reduced, exhaust gas cleaning system fault |  | Trailer ABS fault  |  | Bus at raised level                   |
|  | Starter inhibitor active (clutch not opened)                   |  | Depress brake pedal  |  | Bus at lowered level                  |
|  | Water in fuel filter   |  | Traction control   |  | Level control air pressure too low    |
|  | Parking brake applied  |  | Auxiliary consumers compressed-air supply pressure too low or sensor failure |  | Steering hydraulics oil level too low |
|  | Parking brake supply pressure too low or sensor failure        |  | Compressed-air supply air intake filter dirty                                |  | Axle load transfer active             |
|  | Brake pad wear   |  | Bus not at normal level  |  | Trailing axle steering malfunction    |
|  | Bus stop brake   |  | Bus above normal level   |  | Trailing axle steering inactive       |
|  | Driving and braking characteristics altered                    |  | Bus below normal level   |  | Exterior lighting malfunction         |



























**Overview of the operating, function and malfunction display screen**

| Symbol  | Description                      |
|---|----------------------------------|
|  | Light sensor malfunction         |
|  | Main-beam headlamp malfunction   |
|  | Dipped-beam headlamp malfunction |
|  | Side lamp malfunction            |
|  | Turn signal malfunction          |
|  | Front foglamp malfunction        |
|  | Rear foglamp malfunction         |
|  | Brake lamp malfunction           |









| Symbol  | Description                |
|---|----------------------------|
|  | Reversing lamp malfunction |
|  | Light sensor malfunction   |
|  | Window defrost set to MAX  |
|  | Washer fluid level         |
|  | Rain sensor                |
|  | Rain sensor speed 1        |
|  | Rain sensor speed 2        |
|  | Rain sensor speed 3        |









| Symbol  | Description                     |
|---|---------------------------------|
|  | Rain sensor speed 4             |
|  | Rain sensor speed 5             |
|  | Rain/light sensor malfunction   |
|  | Emergency valve disabled        |
|  | Door 1 emergency valve operated |
|  | Door 2 emergency valve operated |
|  | Emergency hammer removed        |
|  | Door 1 malfunction              |









### Overview of the operating, function and malfunction display screen

| Symbol   | Description                         | Symbol  | Description   | Symbol  | Description                                    |
|--|-------------------------------------|---|---|---|--|
|  | Door 2 malfunction                  |  | Ramp request  |  | Roof hatch emergency unlocked (emergency exit) |
|  | Door 1 anti-trap strip malfunction  |  | Pushchair request   |  | Preglow check                                  |
|  | Door 2 anti-trap strip malfunction  |  | Boarding aid extended   |  | Auxiliary heating combustion indicator         |
|  | Ready to depart                     |  | Service call  |  | Auxiliary heating unit not available           |
|  | Door 2 locked                       |  | Disabled passengers' space stop request                                   |  | Preset timer inoperative                       |
|  | Outwards opening door teach-in mode |  | AC compressor in operation  |  | Water circuit filling process activated        |
|  | Hinged door open                    |  | “Smog” air-recirculation mode for driver’s area and passenger compartment |  | Blower speed adjustment not possible           |
|  | Stop request                        |  | Driver's area air-recirculation mode                                      |  | Passenger compartment regulation OFF           |

Overview of the operating, function and malfunction display screen

| Symbol  | Description                                       |
|---|---|
|  | Refrigerant compressor maintenance run            |
|  | Ignition switch malfunction                       |
|  | Belt warning                                      |
|  | Fire alarm engine compartment/luggage compartment |
|  | Smoke alarm                                       |
|  | Fire extinguishing system malfunction             |
|  | Fuel reserve                                      |
|  | Fuel tank level sensor                            |

| Symbol  | Description                      |
|---|----------------------------------|
|  | AdBlue® fluid level too low      |
|  | Lavatory emergency call          |
|  | Water tank level too low         |
|  | WC holding tank near to overflow |
|  | Water tank 1 empty               |
|  | Water tank 2 empty               |
|  | Roof hatch open                  |
|  | Luggage compartment flap open    |

| Symbol  | Description   |
|---|---|
|  | Luggage compartment and roof hatch open                               |
|  | Engine compartment flap open  |
|  | Side cover and engine compartment flap open                           |
|  | Luggage compartment flap, engine compartment flap and roof hatch open |
|  | FMS (fleet management system) message                                 |
|  | Central locking malfunction   |
|  | Service notification  |
|  | Display check   |

### Electric fuel pump (option)

| Symbol   | Description                     |
|--|---------------------------------|
|  | Take a break (Attention Assist) |

### Electric fuel pump (option)

The electric fuel pump can be used to bleed the fuel system. Press button (1) briefly to switch on the electric fuel pump. The pump will switch off after 85 seconds.

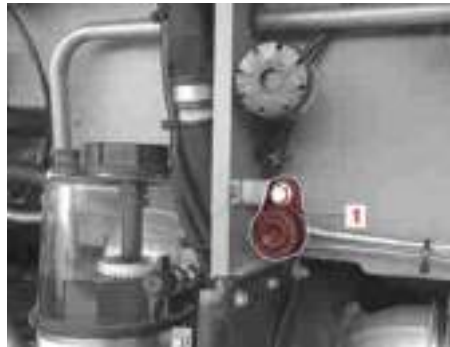

M47\_00-0121-71

### Engine oil level display



M68.00-0547-71

Information about the engine oil level is displayed on display screen (1). Oil level alerts are displayed when the oil level falls below certain thresholds for the first time, and information about the oil level can be called up manually in a specific display screen menu.



**Note:**

Oil level information cannot be called up unless the bus is stationary.



**Caution:**

There is a risk of engine damage if the oil level is too low or too high. For this reason, correct the oil level at the earliest opportunity.



**Note:**

The oil level alerts that may be displayed and the oil level information to which these relate are described in the sections that follow.



**Caution:**

Only the use of low-ash oils specified on MB service products sheet 228.51 is permitted.

**Oil level alerts**

Oil level alerts are displayed to the driver directly by means of event notifications (red alerts).



**Note:**

To be able to acknowledge oil level alerts of the red warning level, the driver has to press the “OK” button on the steering wheel with the parking brake applied.

**Engine oil level too low**

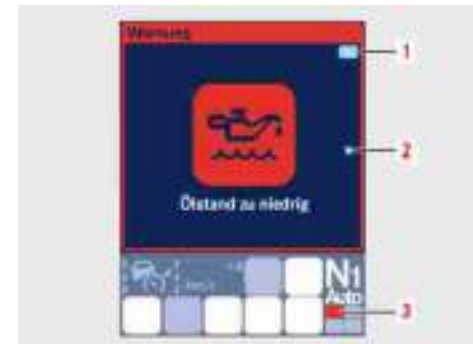

M54.00-1992-71

This red alert appears if the engine oil level is too low. The red alert can be

### Oil level information

closed using “OK” button (1) on the steering wheel. Further fault text can be called up by means of right arrow button (2) on the steering wheel. The oil level must be corrected immediately.

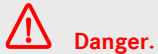

#### Danger.

The oil level must be corrected immediately.



#### Danger.

Risk of accident. In the event of a red alert, the operating safety or roadworthiness of the bus is at risk. The driving and braking characteristics of the bus may change. Stop immediately (traffic conditions permitting) and switch off the engine.

### Oil level information

In the “Fahrzeug” (Vehicle) main menu, select the “Motor” (Engine) submenu. The oil level information informs you whether the oil level is correct or not.



#### Note:

The oil level cannot be measured unless the engine is switched off and the ignition starter switch is in the ON position. The current oil level can be checked no sooner than 5 minutes after engine switch-off.



#### Caution:

The bus must be level when the oil level is measured. If the oil level is measured with the bus on an incline, an incorrect oil level will be displayed on the display screen and a red alert may appear on the instrument panel.



#### Danger.

Risk of accident. Calling up information manually while the vehicle is in motion will distract you from the road and traffic conditions. This could result in an accident with serious or fatal injuries. Therefore: Do not call up information manually unless the bus is stationary and the parking brake is applied.

### Engine oil level OK



M54.00-1993-71

If the engine oil level is within the normal range, this is indicated by the symbol and “OK” (1).



**Note:**

If the oil level is OK, it is not possible to call up any further oil level information.

**Engine oil level too low**



M54.00-2144-71

If the engine oil level is too low, this is indicated by the “Engine oil level” symbol and the message “Niedrig! Öl nachfüllen: 5 l” (Low! Top up oil: 5 L) (1) (5 litres in this example).



**Caution:**

The amount required should be added within the next 200 km.



**Caution:**

The bus must be level when the oil level is measured. If the oil level is measured with the bus on an incline, an incorrect oil level will be displayed on the display screen and a yellow or red alert may appear on the instrument panel.

**Engine oil level not available**



M54.00-1995-71

This indication display will appear if an attempt is made to call up the oil level while the bus is in motion or within 5 minutes of the engine being switched off. The same applies if the oil level cannot be measured for some other reason, e.g. a sensor fault.

### Checking the engine oil level with the dipstick (option)

#### Checking the engine oil level with the dipstick (option)



#### Note:

Park the bus on horizontal ground.



#### Danger.

Prevent the engine from being switched on. Remove the key from the ignition starter switch.

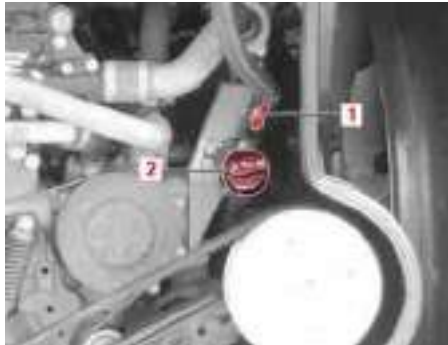

M01.00-0147-71

- ▶ Pull out dipstick (1) with the engine switched off and at normal operating temperature.



#### Note:

After you have switched off the engine, wait approximately 10 minutes to allow the oil to collect in the oil sump.



#### Note:

The oil level must be visible between the minimum and maximum markings.

- ▶ At filler opening (2), add the top-up volume required in accordance with the Specifications for Service Products.



#### Note:

The engines have an electronic oil level sensor that provides a definitive reading.



#### Note:

Top up by the amount required as shown on the display screen. Then run the engine for approximately 20 minutes (idling speed or vehicle in motion). The screen display is updated only after this time has elapsed.



## Safety precautions for work carried out in the engine compartment

### Safety precautions for work carried out in the engine compartment



**Danger.**

Never leave the engine running when work is being carried out in the engine compartment.

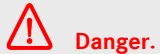

**Danger.**

Prevent the engine from being switched on without authorisation. Remove the key from the ignition starter switch.



**Danger.**

If the engine is at operating temperature, leave it to cool down - risk of burns.

The replacement V-belts, spare parts and assembly tools required are not supplied with the bus as standard.

If the bus has broken down and it is necessary to replace a drive belt but no suitable gauge is available for checking

the tension of the new belt, drive the bus to the nearest OMNIplus Service Partner as soon as possible and have the belt tension and tightening torques checked.

### Removing the drive belts (OM 470)



**Danger.**

Do not carry out work in the engine compartment unless the engine has been switched off and the ignition key has been removed. If the engine is at normal operating temperature, give it sufficient time to cool down: risk of burns.



**Caution:**

Replacement V-belts and some of the tools listed below are not supplied with the bus as standard. Only the use of OMNIplus original replacement V-belts is permitted.

### Removing the drive belts (OM 470)

#### Removing the fan drive belt

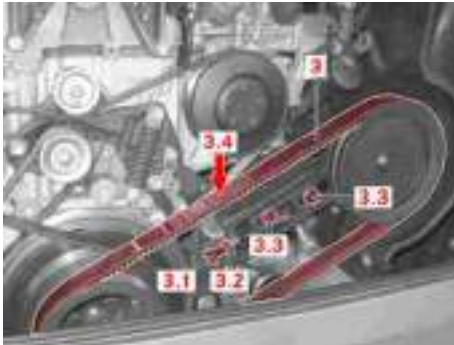

M01\_00-0132-71

- ▶ Loosen lock nut (3.2) of adjustment screw (3.1) on the belt tensioner carrier.
- ▶ Unscrew adjustment screw (3.1).
- ▶ Loosen screws (3.3) securing the belt pulley tensioning lever mounting.
- ▶ Move tensioning lever mounting with belt pulley to the stop against the carrier and remove the drive belt.

#### Removing the drive belt for the refrigerant compressor



#### Note:

Required tools: 1/2" tommy bar.

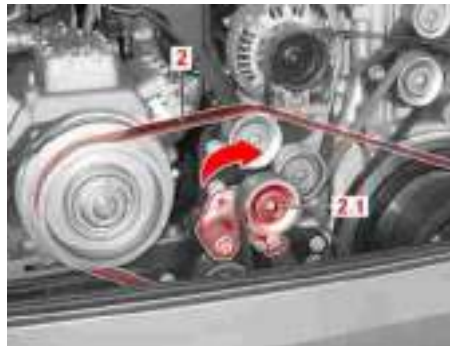

M01\_00-0134-71

- ▶ Fit the 1/2" tommy bar into the socket on tensioning pulley (2.1), pull the tensioning pulley down in the direction of the arrow using the tommy bar and hold in place.
- ▶ Remove the drive belt from the belt pulleys.

#### Removing the drive belt for the right-side alternator

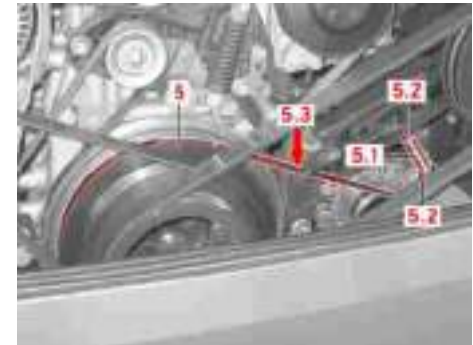

M01.00-0139-71

- ▶ Loosen lock nuts (5.2).
- ▶ Loosen the screws at the alternator hinge point and at the tensioning spindle.
- ▶ Loosen tensioning screw (5.1) until the drive belt is lying loosely on the belt pulleys.
- ▶ Remove drive belt (5) from the belt pulleys.

Fitting the drive belts (OM 470)

Removing the drive belt for the left-side alternator

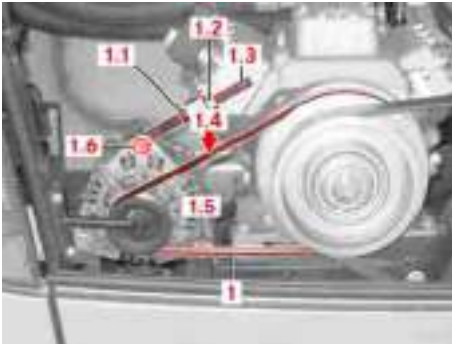

M01.00-0153-71

- ▶ Loosen lock nut (1.2) and loosen the screws at the alternator hinge point (1.5/1.6) and at the tensioning spindle.
- ▶ Loosen clamp nut (1.1) until the drive belt is lying loosely on the belt pulleys.
- ▶ Remove drive belt (1) from the belt pulleys.

Removing the drive belt for the water pump and centre alternator

**i** Note:

Required tools: 1/2" tommy bar.

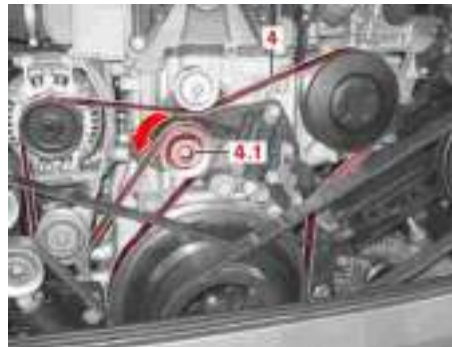

M01\_00-0135-71

- ▶ Fit the 1/2" tommy bar into the socket on tensioning pulley (4.1), pull the tensioning pulley down in the direction of the arrow using the tommy bar and hold in place.
- ▶ Remove the drive belt from the belt pulleys.

Fitting the drive belts (OM 470)

**!** Danger.

Do not carry out work in the engine compartment unless the engine has been switched off and the ignition key has been removed. If the engine is at normal operating temperature, give it sufficient time to cool down: risk of burns.

**!** Danger.

Do not use force (e.g. by using an assembly lever) to pull drive belts onto the belt pulley edges during assembly. Doing so could result in hidden damage to the cord, which would considerably reduce the service life of the belt.

### Fitting the drive belts (OM 470)

#### Fitting the drive belt to the left-side alternator

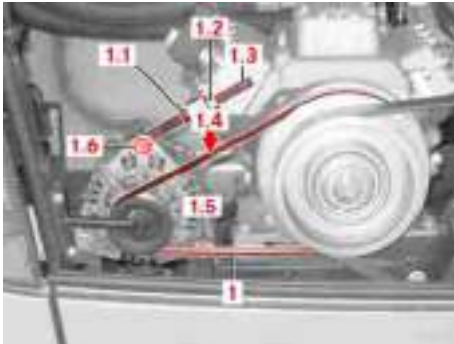

M01.00-0153-71

- ▶ Manually lay new drive belt (1) on the belt pulleys for the alternator and air-conditioning compressor.



#### Caution:

Make sure that the belt profile is aligned with the pulley profile.

- ▶ Tighten tensioning nut (1.1) using an open-ended spanner until the required belt tension has been achieved.



#### Note:

The drive belt tension must not be too high under any circumstances. It must still be possible to twist the drive belt through at least 90° at measuring point (1.4) using two fingers.



#### Caution:

Visit your nearest OMNIplus Service Partner to have the drive belt tension adjusted correctly using a tension meter and to have the screws tightened to the correct torque.

- ▶ Tighten lock nut (1.2) of the tensioning spindle using an open-ended spanner. Tighten the screws at the alternator hinge point (1.5/1.6) and at the tensioning spindle.

#### Fitting the drive belt for the water pump and centre alternator

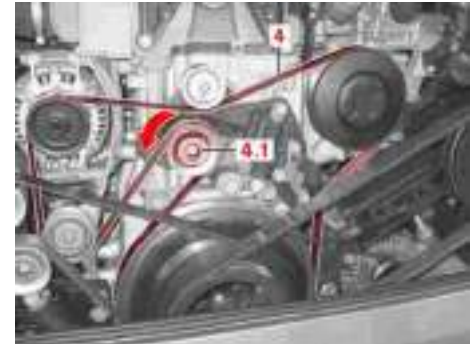

M01\_00-0135-71

- ▶ Manually lay new drive belt (4) on the belt pulleys for the crankshaft and on the idler pulley and belt pulley for water pump and alternator.
- ▶ Fit the 1/2" tommy bar into the socket on tensioning pulley (4.1), turn the tensioning pulley down in the direction of the arrow using the tommy bar and hold in place.
- ▶ Lay drive belt (4) on tensioning pulley (4.1).



**Caution:**

Make sure that the belt profile is aligned with the pulley profile.



**Note:**

Tensioning pulley (4.1) is spring-loaded; the drive belt is therefore adjusted to the correct tension automatically.

**Fitting the drive belt to the right-side alternator**

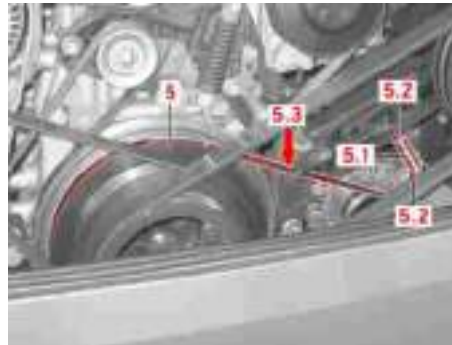

M01.00-0139-71

- ▶ Manually lay new drive belt (5) on the belt pulleys for the right-side alternator and crankshaft.



**Caution:**

Make sure that the belt profile is aligned with the pulley profile.

- ▶ Tighten the tensioning screw until the required belt tension has been achieved.



**Caution:**

The drive belt tension must not be too high under any circumstances. It must still be possible to twist the drive belt through at least 90° at measuring point (5.3) using two fingers.



**Caution:**

Visit your nearest OMNIplus Service Partner to have the drive belt tension adjusted correctly using a tension meter.

- ▶ Tighten lock nuts (5.2) of the tensioning screw using an open-ended spanner. Tighten the screw at the alternator hinge point and at the tensioning spindle.

### Fitting the drive belts (OM 470)

#### Fitting the refrigerant compressor drive belt

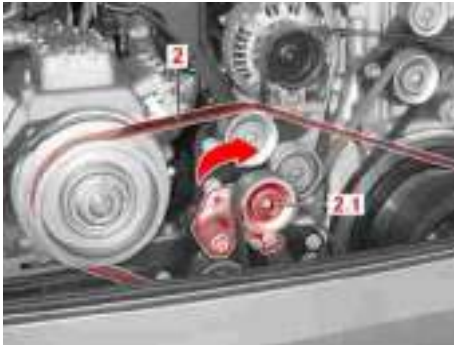

M01\_00-0134-71

- ▶ Manually lay new drive belt (2) on the belt pulleys for the crankshaft and on the idler pulley and belt pulley for the refrigerant compressor.
- ▶ Fit the 1/2" tommy bar into the socket on tensioning pulley (2.1), pull the tensioning pulley down in the direction of the arrow using the tommy bar and hold in place.
- ▶ Lay drive belt (2) on the tensioning pulley.



#### Caution:

Make sure that the belt profile is aligned with the pulley profile.



#### Note:

Tensioning pulley (2.1) is spring-loaded; the drive belt is therefore adjusted to the correct tension automatically.

#### Fitting the fan drive belt

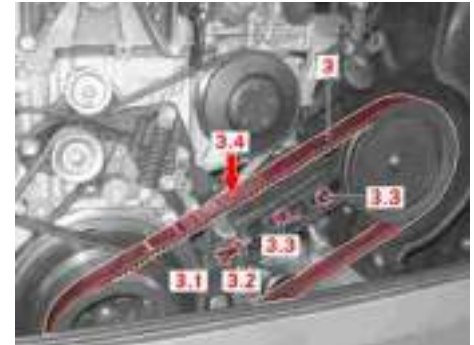

M01\_00-0132-71

- ▶ Manually lay new drive belt (3) on the belt pulleys for the crankshaft and fan drive.
- ▶ Screw adjustment screw (3.1) into the carrier until it makes contact with the tensioning lever mounting.

**Caution:**

The drive belt tension must not be too high under any circumstances. It must still be possible to twist the drive belt through at least 90° at measuring point (3.4) using two fingers.

**Note:**

Visit your nearest OMNIplus Service Partner to have the drive belt tension adjusted correctly using a tension meter.

- ▶ Secure the position of adjustment screw (3.1) using lock nut (3.2)
- ▶ Secure the tensioning lever mounting to the carrier using securing screws (3.3).

**Removing the drive belts (OM 471)****Danger.**

Do not carry out work in the engine compartment unless the engine has been switched off and the ignition key has been removed. If the engine is at normal operating temperature, give it sufficient time to cool down: risk of burns.

**Caution:**

Replacement V-belts and some of the tools listed below are not supplied with the bus as standard. Only the use of OMNIplus original replacement V-belts is permitted.

## Practical advice

### Removing the drive belts (OM 471)

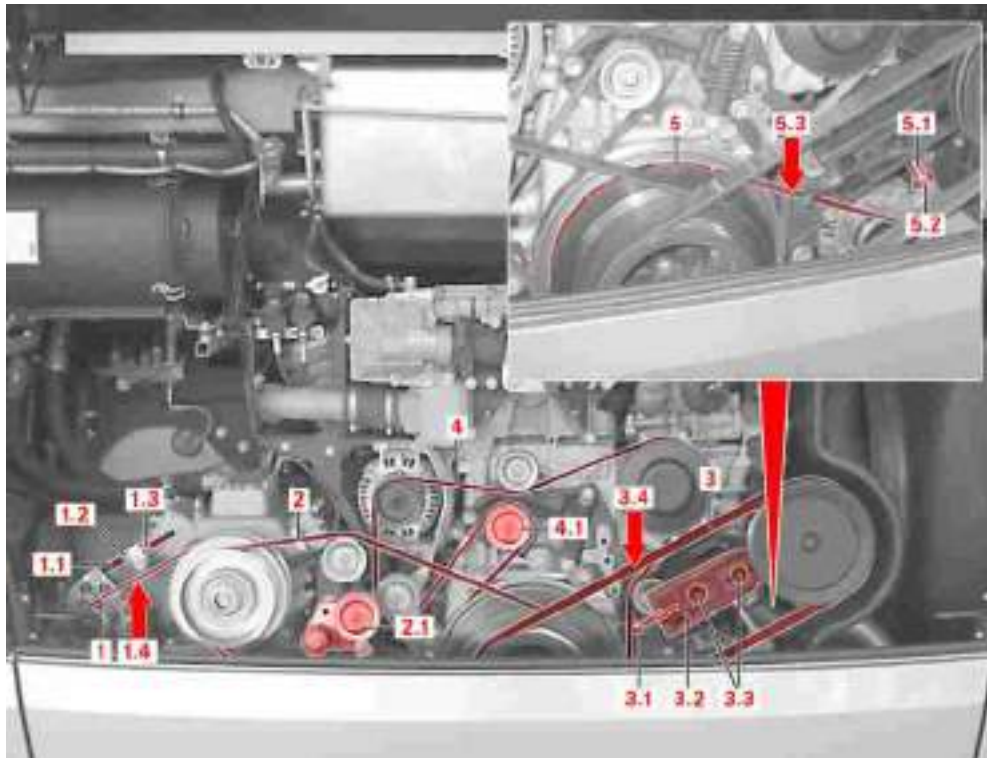



**Overview: OM 470 / OM 471 belt drives**

- 1 Left-side alternator drive belt
  - 1.1 *Tensioning screw*
  - 1.2 *Tensioning nut*
  - 1.3 *Lock nut*
  - 1.4 *Belt tension measuring point*
- 2 Refrigerant compressor drive belt
  - 2.1 *Permanent tensioner*
- 3 Radiator fan drive belt
  - 3.1 *Tensioning screw*
  - 3.2 *Lock nut*
  - 3.3 *Securing screws*
  - 3.4 *Belt tension measuring point*
- 4 Water pump and alternator drive belt
  - 4.1 *Permanent tensioner*
- 5 Right-side alternator drive belt
  - 5.1 *Tensioning screw*
  - 5.2 *Lock nut*
  - 5.3 *Belt tension measuring point*

**Removing the fan drive belt**



M01\_00-0132-71

- ▶ Loosen lock nut (3.2) of adjustment screw (3.1) on the belt tensioner carrier.
- ▶ Unscrew adjustment screw (3.1).
- ▶ Loosen screws (3.3) securing the belt pulley tensioning lever mounting.
- ▶ Move tensioning lever mounting with belt pulley to the stop against the carrier and remove the drive belt.

**Removing the drive belt for the refrigerant compressor**



**Note:**

Required tools: 1/2" tommy bar.

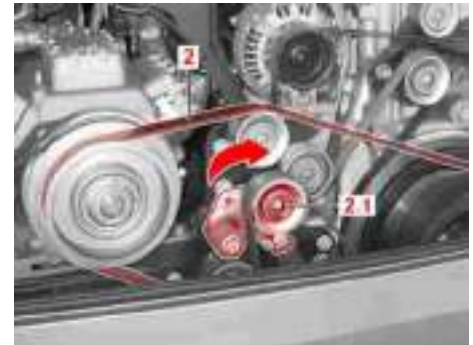

M01\_00-0134-71

- ▶ Fit the 1/2" tommy bar into the socket on tensioning pulley (2.1), pull the tensioning pulley upwards in the direction of the arrow using the tommy bar and hold in place.
- ▶ Remove the drive belt from the belt pulleys.

### Removing the drive belts (OM 471)

#### Removing the drive belt for the right-side alternator

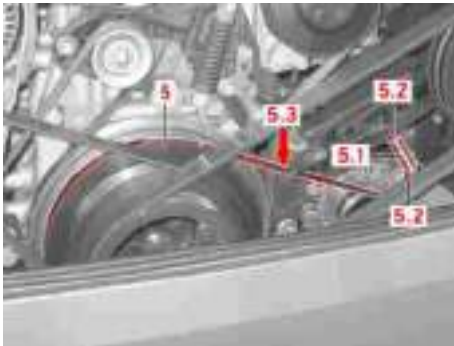

M01.00-0139-71

- ▶ Loosen lock nuts (5.2).
- ▶ Loosen the screw at the alternator hinge point and at the tensioning spindle.
- ▶ Loosen tensioning screw (5.1) until the drive belt is lying loosely on the belt pulleys.
- ▶ Remove drive belt (5) from the belt pulleys.

#### Removing the drive belt for the left-side alternator

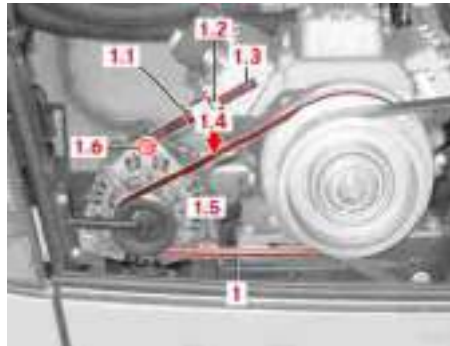

M01.00-0153-71

- ▶ Loosen lock nut (1.2) and loosen the screws at the alternator hinge point (1.3/1.4) and at the tensioning spindle (1.5/1.6).
- ▶ Loosen clamp nut (1.1) until the drive belt is lying loosely on the belt pulleys.
- ▶ Remove drive belt (1) from the belt pulleys.

#### Removing the drive belt for the water pump and centre alternator



#### Note:

Required tools: 1/2" tommy bar.

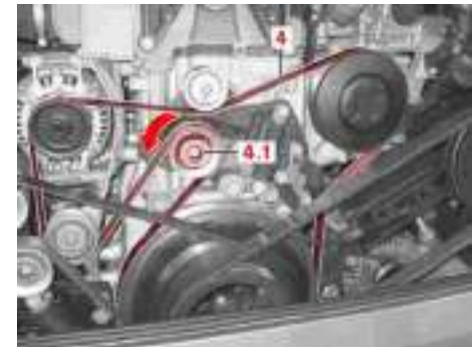

M01\_00-0135-71

- ▶ Fit the 1/2" tommy bar into the socket on tensioning pulley (4.1), pull the tensioning pulley down in the direction of the arrow using the tommy bar and hold in place.
- ▶ Remove the drive belt from the belt pulleys.

## Fitting the drive belts (OM 471)



Do not carry out work in the engine compartment unless the engine has been switched off and the ignition key has been removed. If the engine is at normal operating temperature, give it sufficient time to cool down: risk of burns.



During assembly, do not use force (e.g. with the use of an assembly lever) when pulling drive belts over the belt pulley edges. Doing so could result in hidden damage to the cord, which would considerably reduce the service life of the belt.

## Practical advice

### Fitting the drive belts (OM 471)

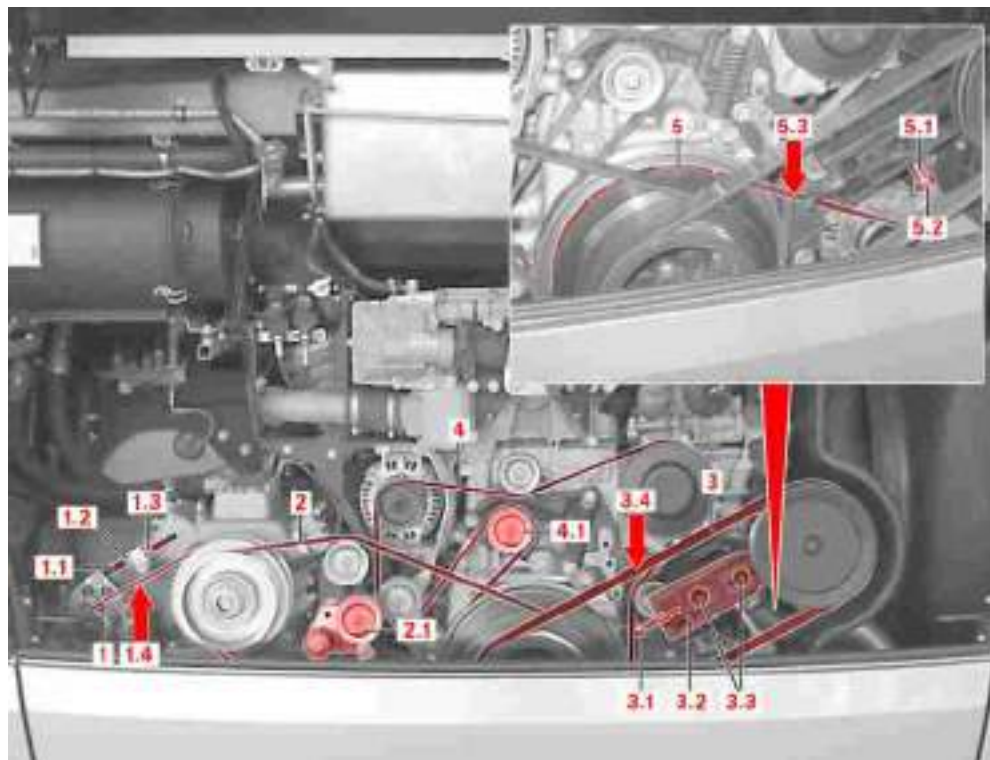

**Overview: OM 470 / OM 471 belt drives**

- 1 Left-side alternator drive belt
  - 1.1 Tensioning screw
  - 1.2 Tensioning nut
  - 1.3 Lock nut
  - 1.4 Belt tension measuring point
- 2 Refrigerant compressor drive belt
  - 2.1 Permanent tensioner
- 3 Radiator fan drive belt
  - 3.1 Tensioning screw
  - 3.2 Lock nut
  - 3.3 Securing screws
  - 3.4 Belt tension measuring point
- 4 Water pump and alternator drive belt
  - 4.1 Permanent tensioner
- 5 Right-side alternator drive belt
  - 5.1 Tensioning screw
  - 5.2 Lock nut
  - 5.3 Belt tension measuring point

**Fitting the drive belt to the left-side alternator**

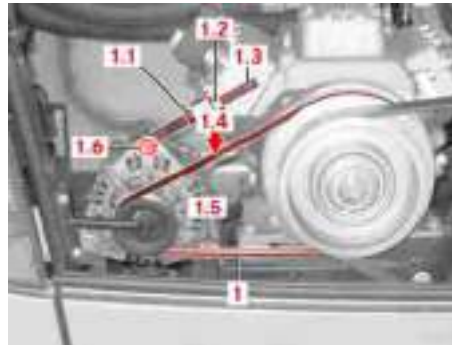

M01.00-0153-71

- ▶ Manually lay new drive belt (1) on the belt pulleys for the alternator and air-conditioning compressor.



**Caution:**

Make sure that the belt profile is aligned with the pulley profile.

- ▶ Tighten tensioning nut (1.1) using an open-ended spanner until the required belt tension has been achieved.



**Note:**

The drive belt tension must not be too high under any circumstances. It must still be possible to twist the drive belt through at least 90° at measuring point (1.4) using two fingers.



**Caution:**

Visit your nearest OMNIplus Service Partner to have the drive belt tension adjusted correctly using a tension meter.

- ▶ Tighten lock nut (1.2) of the tensioning spindle using an open-ended spanner. Tighten the screws at the alternator hinge point (1.5/1.6) and at the tensioning spindle.

### Fitting the drive belts (OM 471)

#### Fitting the drive belt for the water pump and centre alternator

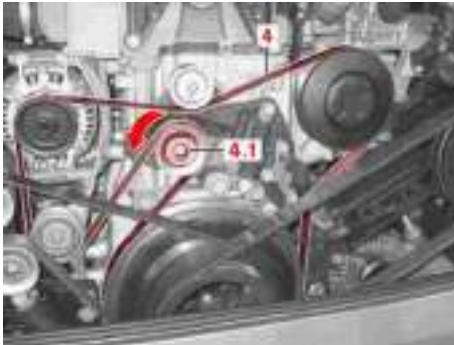

M01\_00-0135-71

- ▶ Manually lay new drive belt (4) on the belt pulleys for the crankshaft and on the idler pulley and belt pulley for water pump and alternator.
- ▶ Fit the 1/2" tommy bar into the socket on tensioning pulley (4.1), pull the tensioning pulley down in the direction of the arrow using the tommy bar and hold in place.
- ▶ Lay drive belt (4) on tensioning pulley (4.1).



#### Caution:

Make sure that the belt profile is aligned with the pulley profile.



#### Note:

Tensioning pulley (4.1) is spring-loaded; the drive belt is therefore adjusted to the correct tension automatically.

#### Fitting the drive belt to the right-side alternator

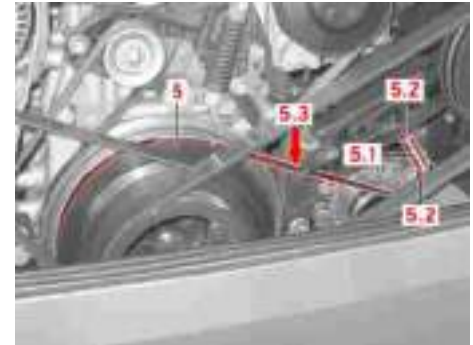

M01.00-0139-71

- ▶ Manually lay new drive belt (5) on the belt pulleys for the right-side alternator and crankshaft.



#### Caution:

Make sure that the belt profile is aligned with the pulley profile.

- ▶ Tighten the tensioning screw until the required belt tension has been achieved.



**Note:**

The drive belt tension must not be too high under any circumstances. It must still be possible to twist the drive belt through at least 90° at measuring point (5.3) using two fingers.



**Caution:**

Visit your nearest OMNIplus Service Partner to have the drive belt tension adjusted correctly using a tension meter.

- ▶ Tighten lock nuts (5.2) of the tensioning screw using an open-ended spanner. Tighten the screws at the alternator hinge point and at the tensioning spindle.

**Fitting the refrigerant compressor drive belt**

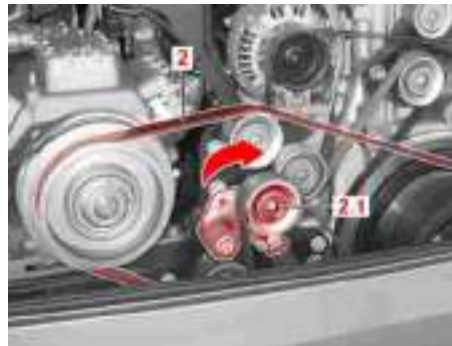

M01\_00-0134-71

- ▶ Manually lay new drive belt (2) on the belt pulleys for the crankshaft and on the idler pulley and belt pulley for the refrigerant compressor.
- ▶ Fit the 1/2" tommy bar into the socket on tensioning pulley (2.1), pull the tensioning pulley down in the direction of the arrow using the tommy bar and hold in place.
- ▶ Lay drive belt (2) on the tensioning pulley.



**Caution:**

Make sure that the belt profile is aligned with the pulley profile.



**Note:**

Tensioning pulley (2.1) is spring-loaded; the drive belt is therefore adjusted to the correct tension automatically.

### Checking the coolant level of the engine and heating system

#### Fitting the fan drive belt

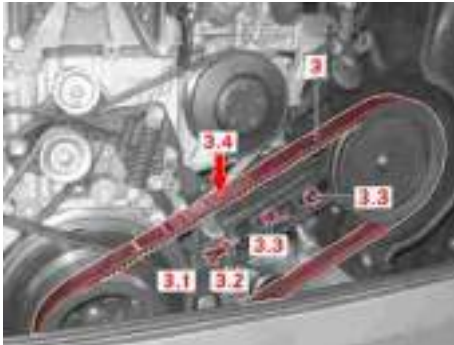

M01\_00-0132-71

- ▶ Manually lay new drive belt (3) on the belt pulleys for the crankshaft and fan drive.
- ▶ Screw adjustment screw (3.1) into the carrier until it makes contact with the tensioning lever mounting.



#### Note:

The drive belt tension must not be too high under any circumstances. It must still be possible to twist the drive belt through at least 90° at measuring point (3.4) using two fingers.



#### Note:

Visit your nearest OMNIplus Service Partner to have the drive belt tension adjusted correctly using a tension meter.

- ▶ Secure the position of adjustment screw (3.1) using lock nut (3.2)
- ▶ Secure the tensioning lever mounting to the carrier using securing screws (3.3).

#### Checking the coolant level of the engine and heating system

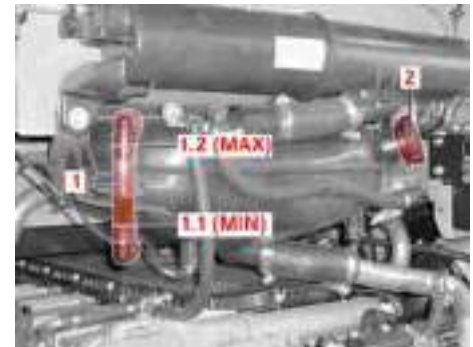

M20.00-0144-71

- ▶ Read off the coolant level



#### Danger.

Risk of scalding to skin and eyes from hot coolant spraying out. Wear protective clothing (gloves/safety goggles). Do not open sealing cap (2) on the coolant expansion tank unless the coolant temperature is below 50 °C. Open sealing cap (2) slowly to relieve the excess pressure. Slowly turn the sealing cap a little further and remove it. Risk of poisoning if coolant is swallowed.



Tyres - operating safety and roadworthiness



**Note:**

The coolant level must be between the upper and lower marks (minimum (1.1) and maximum (1.2)) at expansion tank inspection glass (1) when the engine is cold (below 50 °C).

► Add coolant



**Caution:**

Do not top up unless the engine is cold.



**Note:**

Use clean water – well filtered and as soft as possible (drinking water quality) – mixed with corrosion inhibitor/antifreeze (comply with the Specifications for Service Products).



**Note:**

Only the use of a coolant specified on MB Specifications for Service Products sheet 325.5 or 326.5 (G40) is permitted. (The colour of the coolant is pink.)



**Note:**

For notes on bleeding the heating system coolant circuit, refer to the “Practical advice” section.

**Tyres - operating safety and roadworthiness**

Tyres are particularly important for the operating safety and roadworthiness of the bus.



**Note:**

The pressure, tread and condition of the tyres should therefore be checked on a regular basis.



**Caution:**

The use of wheel balancing agents, such as balancing powder, beads or gel, is not permitted as these may lead to undesirable pulsations and/or vibrations.

### Tyre pressure

#### Tyre pressure

Check the specified tyre pressure regularly – at least once a week and before longer journeys – when the tyres are cold.



#### **Danger.**

Always observe the specified tyre pressures for your bus. The temperature and pressure of the tyres increase when the bus is in motion. For this reason, you should never reduce the pressure of warm tyres. The tyre pressures would then be too low once the tyres had cooled. If the tyre air pressure is too low, the tyre is liable to burst, particularly with increasing numbers of passengers/load and speed. This could result in you losing control of your bus and causing an accident, thereby injuring yourself and other people.



#### **Note:**

If the tyre pressure is too low, this leads to intensive heating of the tyres, increased tyre wear, changes in directional stability and increased fuel consumption.



#### **Note:**

If the tyre pressure is too high, this results in a longer braking distance, poorer tyre grip and increased tyre wear.



#### **Caution:**

Caps on the tyre inflation valves protect the valve inserts from moisture and dirt. The caps on the tyre inflation valves should therefore always be screwed on tightly.

#### On-screen tyre pressure monitor

The “Tyres” menu window is available in buses equipped with electronic tyre pressure monitoring.

The tyre pressure monitor is a convenience system designed to help you to check tyre pressures regularly and issues a warning if a tyre is overinflated or loses pressure.



#### **Danger.**

It is always your responsibility to ensure that the tyres are inflated to the correct pressure.



#### **Note:**

Tyre pressure increases or decreases by approximately 30 to 40 kPa (0.3 to 0.4 bar, 4.4 to 5.8 psi) with every 10 °C increase or decrease in air temperature respectively. Bear this temperature-related change in tyre pressure in mind if you are checking tyre pressures indoors and the temperature indoors is higher than the temperature outdoors. Example: Room

temperature is approximately 20 °C. Outside temperature is approximately 0 °C. In this case, the tyre pressure would be 60 to 80 kPa (0.6 to 0.8 bar, 8.7 to 11.6 psi) higher than the value specified in the tyre pressures table.

The tyre pressure monitor monitors the pressure in all tyres while the bus is stationary and while the bus is in motion.

 **Note:**

The warnings issued by the tyre pressure monitor cannot be reliable unless the tyres have been inflated to the correct nominal pressure. The tyre pressure monitor would work with an incorrect value if, for example, your vehicle were overladen or laden incorrectly or if you were to fit wheels with a different tyre size to the vehicle and did not correct the nominal pressure in the on-board computer or entered an incorrect value. Refer to the tyre pressures table to check that the nominal pressure has been set correctly. An underinflated tyre would lead to instability while the bus is in motion and therefore an increased risk of accident.

Have the correct nominal pressure set in the on-board computer at a qualified specialist workshop.

 **Note:**

If radio transmitting equipment (e.g. radio headphones, two-way radios) is being operated inside the bus or nearby, this could interfere with the correct functioning of the tyre pressure monitor. The display screen in the instrument cluster displays “-” in place of the respective tyre pressure if a tyre pressure sensor is temporarily suffering interference, e.g. from radio transmitting equipment, or if the tyre pressure sensor has not yet supplied any values. Wait a few minutes and/or drive the vehicle away from the area affected by the radio transmitting equipment. The tyre pressure values shown on the display screen may differ from the readings obtained with an air pressure gauge. The tyre pressure displayed by the on-board computer relate to sea level. At higher locations, air pressure gauges display a higher tyre pressure than the display screen does. Do not reduce tyre pressure in this situation. The tyre pres-

sure monitor detects new wheels or new tyre pressure sensors automatically. Drive the bus for a few minutes at a speed of over approximately 18 mph (30 km/h).

### Tyre tread

#### Tyre tread

A minimum tyre tread depth is specified by law. Comply with the legal specifications for the relevant country.

As the remaining tread depth reduces, the less effective the road grip and handling characteristics of the bus become, particularly on wet or snowy roads.

In the interest of safety, have the tyres replaced before the legally-specified minimum tread depth is reached.

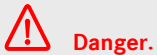

#### **Danger.**

Always ensure that there is sufficient tyre tread. Insufficient tyre tread depth increases the risk of aquaplaning if the bus is driven at high speed during heavy rain or in slush. The tyre tread can no longer deflect the water away. This could result in you losing control of your bus and causing an accident, thereby injuring yourself and other people.

#### Tyre condition

Before setting off, check the tyres on the bus for:

- external signs of damage
- foreign objects in the tyre tread
- foreign objects between twin tyres
- cracks, bulges



#### **Danger.**

Please note that cracks, bulges or external damage can cause a tyre to burst. This could result in you losing control of the bus and causing an accident, thereby injuring yourself and other people. Have damaged tyres replaced with new ones immediately.

#### Tyre age

Have the tyres changed at least every six years, irrespective of wear. This also applies for the spare wheel.



#### **Danger.**

The sun's rays and environmental factors cause tyres to age. The rubber from which the tyre is made loses elasticity. Tyres harden and become brittle, cracks appear due to ageing. Tyres which are more than six years old are no longer reliable.

**Invisible tyre damage**

Avoid crushing tyres against the kerb or switching off the bus when a part of the tyre tread is up on the kerb.

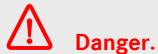
**Danger.**

Driving over the edge of the kerb or sharp edged objects can cause damage to the tyre substructure which is not visible externally. Damage to the tyre substructure only becomes noticeable much later and could cause the tyre to burst. This could result in you losing control of your bus and causing an accident, thereby injuring yourself and other people.

**Tyre load capacity, top speed of tyres and types of tyres**

3-axle models require wheels and tyres with increased load-bearing capacity.

**Note:**

Tyres with increased load capacity are specially marked. The load index must be 154/148 or 154/149.

**Danger.**

Exceeding the specified tyre load capacity or the approved maximum tyre speed could lead to tyre damage or tyre failure. You could then lose control of your bus and cause an accident, which could result in injury to yourself and others. For this reason, use only the tyre types and sizes approved for your bus model and observe the required tyre load capacity and speed index for your bus. Pay particular attention to country-specific tyre approval regulations. These regulations may specify a particular type of tyre for your bus or prohibit the use of particular tyre types that may be approved in other

countries. In addition, it may be advisable to use a specific type of tyre in certain regions or areas of use. You can obtain information on tyres from any OMNIplus Service Partner.

Where twin tyres are fitted, the twin tyres must have the same external diameter, otherwise the tyre that has the largest diameter will be overloaded. Tip: The simplest and most reliable measurement method is to check circumferences using a circumference tape.

**Note:**

The maximum tolerance for twin tyres is 0.5% of the tyre diameter. The larger tyre must always be fitted in the outboard position.

### Retreaded tyres















#### Retreaded tyres

It is advisable to use only tyres and wheels that EvoBus has tested and approved specifically for your vehicle.



## Tyre pressures table 295/80 R 22.5

### Tyre pressures table 295/80 R 22.5

|                 |             | [bar]   | 6,0  | 6,5   | 6,75  | 7,0   | 7,25  | 7,5   | 7,75  | 8,0   | 8,25  | 8,5   | 8,75 | 9,0 |
|-----------------|-------------|---|------|-------|-------|-------|-------|-------|-------|-------|-------|-------|------|-----|
| 295 / 80 R 22.5 | Michelin    |  • | 5180 | 5560  | 5760  | 5950  | 6140  | 6330  | 6520  | 6720  | 6910  | 7100  | --   | --  |
|                 |             |  • | 9190 | 9880  | 10220 | 10560 | 10900 | 11240 | 11580 | 11920 | 12260 | 12600 | --   | --  |
|                 | Continental |  • | 5370 | 5725  | --    | 6075  | --    | 6420  | --    | 6760  | --    | 7100  | --   | --  |
|                 |             |  • | 9535 | 10165 | --    | 10785 | --    | 11395 | --    | 12000 | --    | 12600 | --   | --  |
|                 | Dunlop      |  • | 5380 | 5730  | 5910  | 6080  | 6260  | 6430  | 6600  | 6770  | 6940  | 7100  | --   | --  |
|                 |             |  • | 9540 | 10170 | 10480 | 10790 | 11100 | 11400 | 11710 | 12010 | 12310 | 12600 | --   | --  |
|                 | Goodyear    |  • | 5380 | 5730  | 5910  | 6080  | 6260  | 6430  | 6600  | 6770  | 6940  | 7100  | --   | --  |
|                 |             |  • | 9540 | 10170 | 10480 | 10790 | 11100 | 11400 | 11710 | 12010 | 12310 | 12600 | --   | --  |
|                 | Bridgestone |  • | 5370 | 5720  | 5900  | 6070  | 6250  | 6420  | 6590  | 6760  | 6930  | 7100  | --   | --  |
|                 |             |  • | 9530 | 10160 | 10470 | 10780 | 11090 | 11390 | 11700 | 12000 | 12300 | 12600 | --   | --  |
|                 | Firestone   |  • | 5370 | 5720  | 5900  | 6070  | 6250  | 6420  | 6590  | 6760  | 6930  | 7100  | --   | --  |
|                 |             |  • | 9530 | 10160 | 10470 | 10780 | 11090 | 11390 | 11700 | 12000 | 12300 | 12600 | --   | --  |
|                 | Pirelli     |  • | --   | 5730  | 5900  | 6080  | 6250  | 6420  | 6590  | 6760  | 6930  | 7100  | --   | --  |
|                 |             |  • | --   | 10170 | 10480 | 10790 | 11090 | 11400 | 11700 | 12000 | 12300 | 12600 | --   | --  |

MAG 95-0001-01



## Safety measures to be taken in the event of a flat tyre or a wheel change

The figures in the table show the respective axle load in kg. The first row of the table shows the tyre pressure to be set (in bar).



**Note:**

3-axle models are equipped with tyres having an increased load capacity (154/148 or 154/149). These tyres have a maximum pressure of 8.5 bar for 7.5 t axle load (single-tyre version).



**Note:**

The tyre pressures table shown here cannot be considered complete and is primarily provided for guidance only. The tyre catalogue of the manufacturer concerned is the decisive point of reference for the precise tyre pressures to be set in accordance with the current axle load.

### Safety measures to be taken in the event of a flat tyre or a wheel change



**Danger.**

Park the bus as far away as possible from the traffic and on firm ground. Switch on the hazard warning lamps. Let all passengers disembark and move them out of the danger zone (e.g. behind the crash barrier). Position a warning triangle or hazard warning light at a suitable distance. Observe the legal requirements of the country concerned.



**Danger.**

Only change the wheel on a level, firm and non-slip surface. The bus or jack may slip out to the side on a soft or slippery surface (snow, ice, smooth surface, etc.).

### Fitting snow chains



#### **Danger.**

Never lie under the bus if it is raised up and is not supported by axle stands. Do not start the engine as there is a risk of fatal injury. Safeguard the engine against being switched on without authorisation. Remove the key from the ignition switch.

#### Fitting snow chains

- ▶ The following instructions and information must be observed:



#### **Note:**

Observe legal requirements and the installation instructions provided by the manufacturer.



#### **Note:**

Only RUD-MATIC MAXI chains are permitted.



#### **Note:**

Snow chains may be fitted more easily, especially at the rear axle, by raising the bus using the raising/lowering system.



#### **Danger.**

Make sure that the snow chains are fitted tightly. Do not exceed the maximum permissible speed of 40 km/h.



#### **Note:**

Check the snow chains for firm seating after you have driven a certain distance (dependent on prevailing conditions) and retighten them if necessary.

## Removing the spare wheel from the spare wheel cover

### Removing the spare wheel from the spare wheel cover



M00\_00-0575-71

- ▶ Pull handle (1) in the front right doorway to open the front cover

#### **i** Note:

The spare wheel is located behind the front cover in the front end under the driver's station

#### **i** Note:

The openings below the spare wheel in the front compartment must not be sealed or covered by objects as trouble-free operation of the heating, ventilation and air-conditioning system would no longer be guaranteed.

The front cover opens forwards gently

#### **i** Note:

If the cover opens only a little, reach into the gap and pull the cover open



M40\_00-0072-01

- ▶ Unhook retaining strap (4) from position (b) and hook back into position (a).

#### **i** Note:

Hold the spare wheel cover as you do this to avoid damage.

The spare wheel cover is now in the horizontal position and it is possible to pull the spare wheel out.

### Positioning the jack

- ▶ Undo and remove the spare wheel retaining strap



M40\_00-0072-01

- ▶ Pull spare wheel (1) towards you over roller bar (3)

### Positioning the jack

- ▶ Observe the safety precautions.



**Danger.**

Follow the jack manufacturer's instructions.



**Danger.**

Depending on the bus model, either a 10 t jack or a 5 t and a 10 t jack are available on-board. Use in accordance with intended use.



**Danger.**

Secure the bus against rolling away (apply the parking brake). Also chock at least one front wheel if there is a defective wheel on the rear axle.

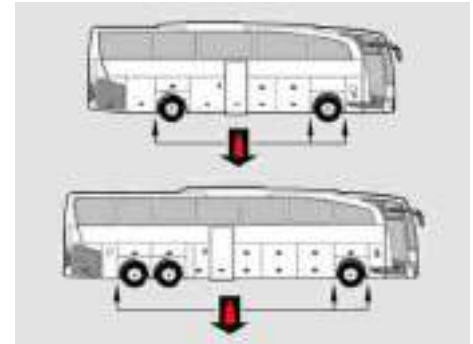

M00\_00-0320-01

- ▶ Positioning the jack



**Danger.**

The jacking points on the skeleton are marked on the outside of the bus by a jack symbol. Make sure that you follow the instructions in the relevant section of this manual for positioning the jack when changing a wheel.



**Danger.**

In order to prevent damage to the skeleton, jacks should be positioned at the designated jacking points only. If axle stands are not available, the good spare wheel or the defective wheel must be positioned at a suitable position under the body for the duration of the wheel fitting/removal procedure to provide protection in case the jack should fail.

Removing the wheel trims

Removing the wheel trims

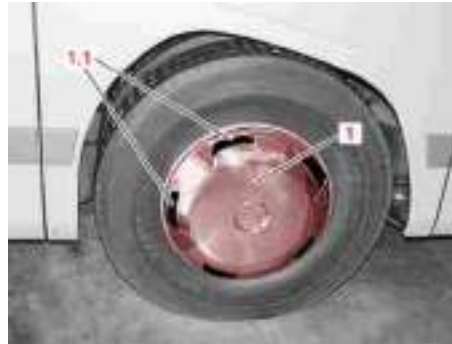

M40\_00-0007-01

- ▶ Insert both hands into the ventilation slots (1.1) and grip the wheel trims (1).

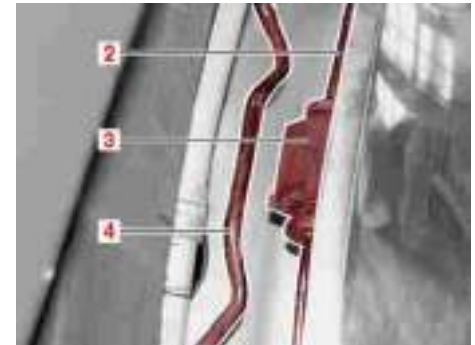

M40\_00-0008-01

- ▶ After you have reached into the wheel trims, firstly detach clamp ring (2) from retaining clip (3). This reduces the compression force on clamp ring (4) and the wheel trim can be removed more easily.

### Removing the wheels

#### Removing the wheels

#### Removing a front wheel



M40\_00-0084-71

- ▶ Place a ramp at the defective wheel and drive the bus onto it

#### **i** Note:

If the ground is very slippery and hard, the ramp may slide out from under the wheel when the bus is driven onto it. Observe the information and instructions on the ramp instruction plate.

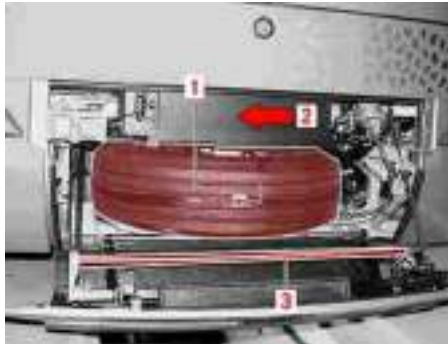

M40\_00-0023-01

- ▶ Loosen the wheel nuts using the wheel nut wrench from the vehicle tool kit.

#### **i** Note:

Roller bar (3), on top of which the spare wheel is pulled out from the spare wheel cover, is suitable as an extension. It can be pulled out of the retaining bracket after the spring pin has been removed.



M40\_00-0011-01

- ▶ Position the telescopic jack (10 t) on a laminated wooden base and raise the bus at the transverse link jacking point (arrowed)

#### **Organisational resource**

Telescopic jack (10 t)

#### **Tools to be self-made**

Laminated wood base



**Note:**

Extend the telescopic jack the maximum distance so that there is a gap between the wheel and the ramp



**Danger.**

If support stands are not available, the spare wheel or the defective wheel must be placed under the body at a suitable position for the duration of the tyre change to provide protection in case the jack should fail.

- ▶ Remove the ramp
- ▶ Unscrew and remove all wheel nuts apart from three nuts spaced equally apart
- ▶ Do not unscrew the last three wheel nuts until you are sure that the wheel is seated on the wheel bolts without tension
- ▶ Remove the defective wheel



**Caution:**

When you remove the wheel, take great care not to scrape it over the threads of the wheel bolts. This would damage the bolt threads and make it difficult to screw on the wheel nuts. In the worst case scenario, a wheel nut could become seized on a damaged wheel bolt.

**Removing a wheel from the driven axle**



M40\_00-0012-01

- ▶ Place a ramp at the good wheel of the twin tyres and drive the bus onto it



**Note:**

If the ground is very slippery and hard, the ramp may slide out from under the wheel when the bus is driven onto it. Observe the information and instructions on the ramp instruction plate.

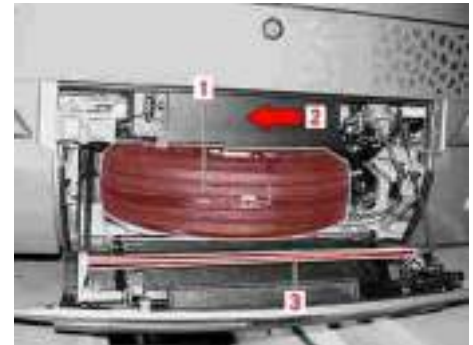

M40\_00-0023-01

- ▶ Loosen the wheel nuts using the wheel nut wrench from the vehicle tool kit.

### Removing the wheels



#### Note:

Roller bar (3), on top of which the spare wheel is pulled out from the spare wheel cover, is suitable as an extension. It can be pulled out of the retaining bracket after the spring pin has been removed.



M40\_00-0013-01

- ▶ Position the telescopic jack (10 t) on a laminated wooden base and raise the bus at the jacking point (arrowed)

#### Organisational resource

Telescopic jack (10 t)

#### Tools to be self-made

Laminated wood base



#### Note:

Extend the telescopic jack the maximum distance so that there is a gap between the wheel and the ramp



#### Danger.

If support stands are not available, the spare wheel or the defective wheel must be placed under the body at a suitable position for the duration of the tyre change to provide protection in case the jack should fail.

- ▶ Remove the ramp
- ▶ Unscrew and remove all wheel nuts apart from three nuts spaced equally apart
- ▶ Do not unscrew the last three wheel nuts until you are sure that the wheel

is seated on the wheel bolts without tension

- ▶ Remove the defective wheel



#### Caution:

When you remove the wheel, take great care not to scrape it over the threads of the wheel bolts. This would damage the bolt threads and make it difficult to screw on the wheel nuts. In the worst case scenario, a wheel nut could become seized on a damaged wheel bolt.



Removing a wheel from the trailing axle



M40\_00-0014-01

- ▶ Drive the outside wheel of the driven axle onto ramp (1).



Note:

If the ground is very slippery and hard, the ramp may slide out from under the wheel when the bus is driven onto it. Observe the information and instructions on the ramp instruction plate.

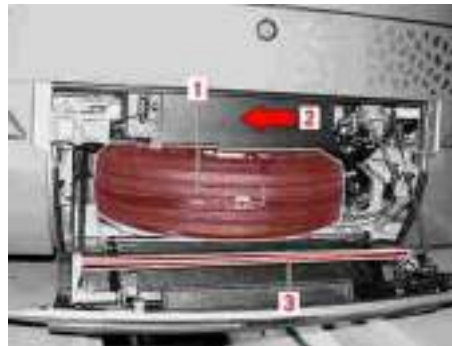

M40\_00-0023-01

- ▶ Loosen the wheel nuts with the wheel nut wrench from the vehicle tool kit through no more than half a turn.



Note:

Roller bar (3), on top of which the spare wheel is pulled out from the spare wheel cover, is suitable as an extension. It can be pulled out of the retaining bracket after the spring pin has been removed.



Danger.

If support stands are not available, the spare wheel or the defective wheel must be placed under the body at a suitable position for the duration of the tyre change to provide protection in case the jack should fail.

- ▶ Raise the bodywork using the raising/lowering system.

Organisational resource

Telescopic jack (10 t)



Danger.

It is essential that the battery isolating switch 01S01 be switched to OFF afterwards.

### Removing the wheels



M40\_00-0086-71

- ▶ Raise the trailing axle at the transverse link jacking point (arrowed) using the telescopic jack (10 t) to the point at which the spare wheel can be fitted.

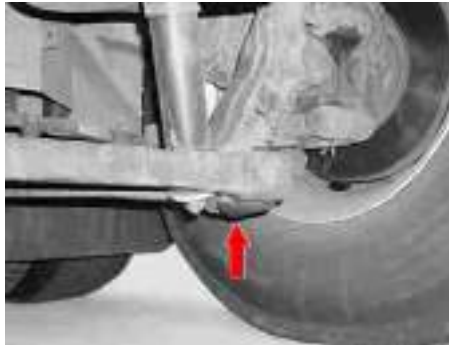

M40\_00-0087-71

- ▶ Unscrew and remove all wheel nuts apart from three nuts spaced equally apart.

#### Organisational resource

Telescopic jack (5 t)

- ▶ Remove the ramp
- ▶ Unscrew and remove all wheel nuts apart from three nuts spaced equally apart.
- ▶ Do not unscrew the last three wheel nuts until you are sure that the wheel is seated on the wheel bolts without tension

- ▶ Remove the defective wheel



#### Caution:

When you remove the wheel, take great care not to scrape it over the threads of the wheel bolts. This would damage the bolt threads and make it difficult to screw on the wheel nuts. In the worst case scenario, a wheel nut could become seized on a damaged wheel bolt.

**Fitting the spare wheel**

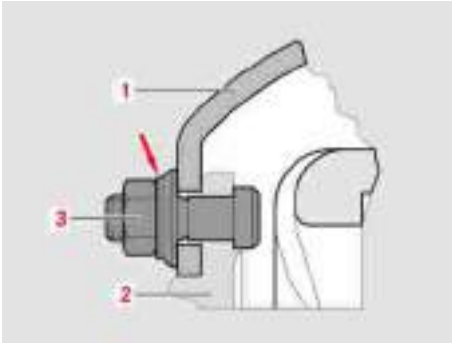

M40\_00-0016-01



**Caution:**

Where necessary, remove rust and dirt from the contact surfaces on the wheel, wheel hub, centring lugs and wheel nuts.



**Danger.**

The thread of the wheel bolts and wheel nuts must be free of oil and grease. Degrease the thread if necessary.

- ▶ Fit the spare wheel



**Danger.**

If the bus is equipped with pressed-steel wheels, the spare wheel to be fitted must also be a pressed-steel wheel. Similarly, an aluminium disc wheel must be fitted during a wheel change if the bus is equipped with aluminium disc wheels. Light-alloy wheels and pressed-steel wheels require a different type of wheel nut.



**Note:**

Disc wheels (1) are centred by the centring lugs on hub (2).



M40\_00-0053-01

- ▶ Fit the wheel nuts and screw them on into contact with the wheel.



**Danger.**

Note the different flat collar nuts. A: Wheel nuts for pressed-steel wheels (steel rims) do not have any marking. B: Wheel nuts for aluminium wheels (aluminium rims) bear the inscription “VA FA” for single tyres, “HA RA” for twin tyres and a marking with 3 rings on the integral thrust washer (see illustration).

### Fitting the spare wheel



#### **Danger.**

Always select the correct nuts for the type of wheel concerned.



M40\_00-0061-01

- ▶ For vehicles with light-alloy wheels (aluminium rims), slide the assembly sleeves (vehicle tool kit) over 2 opposing wheel bolts to avoid damage during removal and refitting.
- ▶ Place the ramp back under the wheel, lower the bus and take the jack away.



#### **Note:**

If you do not push the ramp under the wheel, it will not be possible to remove the jack.

- ▶ Tighten the wheel nuts in a crosswise pattern

#### **Tightening torque**

Wheel nuts: 600 Nm



#### **Danger.**

Tighten the wheel nuts using the available tool and drive cautiously to the nearest OMNIplus Service Partner. Have the wheel nuts tightened to the specified torque.



#### **Danger.**

If you use an impact wrench, tighten the wheel nuts only slightly in a crosswise pattern first and then tighten the nuts to the specified torque using a torque wrench.

- ▶ Drive the bus off the ramp



#### **Danger.**

The wheel nuts must be retightened after the bus has covered 50 km.

Fitting the wheel trims

Fitting the wheel trims

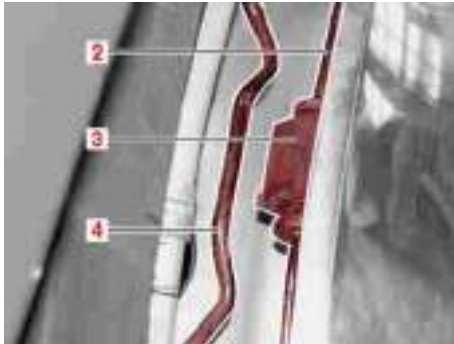

M40\_00-0008-01

- ▶ Place the wheel trim on the clamp ring (4). When you do this you should insert the retaining clip lugs (3) of the wheel trim into the clamp ring cut-out (4). Attach the lower retaining clips and press on. Then press the wheel trim into the other retaining clips.



**Danger.**

Make sure that the wheel trim is seated correctly. All retaining clips (3) must be fixed behind clamp ring (4).

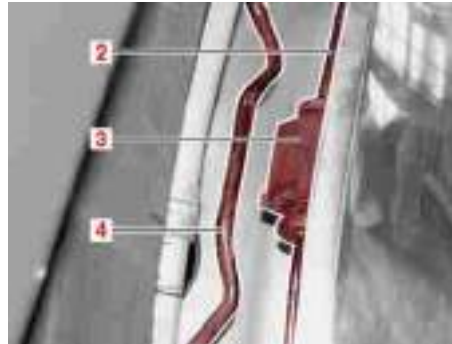

M40\_00-0008-01

- ▶ Push in the last top retaining clips with the clamp ring detached. This considerably reduces the amount of force required and you also avoid the possibility of damaging the wheel trim. After you have fitted the wheel trim, reach into the ventilation openings and hook clamp ring (2) into retaining clip (3) again. The retain-

ing clips must not rest on a balance weight.

### Inflating tyres using the tyre inflator connection

#### Inflating tyres using the tyre inflator connection

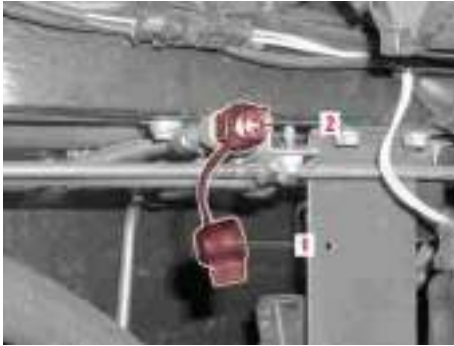

M40\_00-0078-71

- ▶ Remove protective cap (1) from tyre inflator connection (2)



#### Note:

While the engine is running, a pressure of up to 12.5 bar (cut-out pressure of the pressure regulator) can be drawn off. Compressed air cannot be drawn off unless the pressure regulator is in the fill position. If the pressure regulator has cut out (idle position - blows into the open air), it will be necessary to reduce the pressure using the pedal-operated brake

valve until the pressure regulator cuts in again.



#### Caution:

Since the pressure in the system may be too high for inflating a tyre, the inflation procedure should be monitored by observing the compressed-air reservoir pressure operating display on the instrument cluster screen.

- ▶ Pump air out of the compressed-air system (using the pedal) until the supply pressure for circuits 1 and 2 indicated by the supply pressure operating display drops below 6.5 - 7 bar.



M40.00-0135-71

- ▶ Screw on valve connector (4), if not already fitted, to the other end of the tyre inflation hose using the wing nut.

## Inflating tyres using the tyre inflator connection

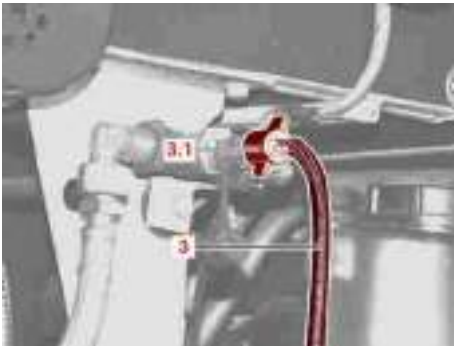

M40\_00-0019-01

- ▶ Screw tyre inflation hose (3) onto the tyre inflator connection to the stop using the wing nut (3.1).

**i** **Note:**

Position the hose so that the engine compartment flap can be closed.

- ▶ Unscrew the protective cap from the tyre valve and connect valve connector (4).
- ▶ Close the engine compartment flap
- ▶ Start the engine and inflate the tyres to the specified pressure (approx-

imately 8.5 bar), then switch off the engine.

**i** **Note:**

Observe the operating display for the supply pressure in circuits 1 and 2.

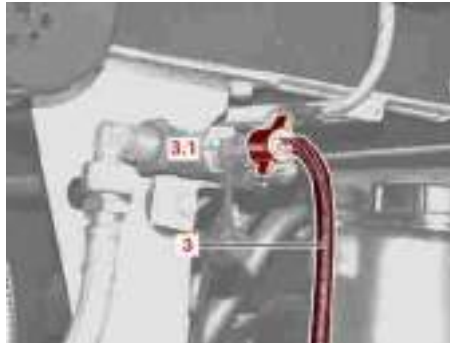

M40\_00-0019-01

- ▶ After you have finished inflating the tyres, unscrew tyre inflation hose (3) and seal the tyre inflator connection with the rubber cap.

**!** **Danger.**

Never drive the bus with the tyre inflation hose still connected.

**!** **Danger.**

Inflate the tyres to the specified pressure at the earliest opportunity.

## Practical advice

### Pneumatic system test ports under the driver's area

Pneumatic system test ports under the driver's area





**Pneumatic system test ports under the driver's area**

|       |  |       |                                   |
|-------|--|-------|-----------------------------------|
|       | Pneumatic test ports (behind the left-hand service cover under the driver's area). | TP 12 | <i>Suspension supply pressure</i> |
| TP 1  | <i>Auxiliary consumers supply pressure</i>   |       |                                   |
| TP 2  | <i>Spring-actuated parking brake supply pressure</i>                               |       |                                   |
| TP 3  | <i>Front axle brake supply pressure</i>  |       |                                   |
| TP 4  | <i>Driven axle brake supply pressure</i>   |       |                                   |
| TP 5  | <i>Brake pressure regulated on the left-hand side of the front axle</i>            |       |                                   |
| TP 6  | <i>Brake pressure regulated on the right-hand side of the front axle</i>           |       |                                   |
| TP 7  | <i>Spring-actuated parking brake control pressure</i>                              |       |                                   |
| TP 8  | <i>Spring-actuated parking brake emergency release control pressure</i>            |       |                                   |
| TP 9  | <i>Driven axle brake pressure (redundancy)</i>                                     |       |                                   |
| TP 10 | <i>Not assigned</i>  |       |                                   |
| TP 11 | <i>Not assigned</i>  |       |                                   |

## Practical advice

### Pneumatic test ports behind door 2

#### Pneumatic test ports behind door 2

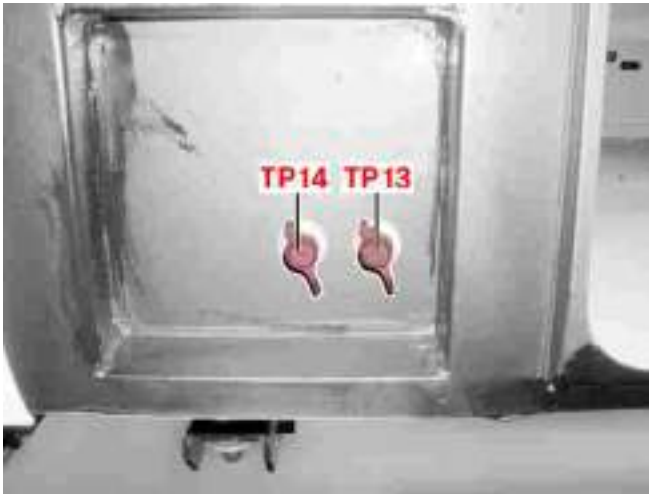

Pneumatic test ports (behind the right-hand luggage compartment flap to the front of the driven axle).

- TP 13 Brake pressure regulated on the right-hand side of the driven axle*
- TP 14 Brake pressure regulated on the right-hand side of the trailing axle (only on buses with third axle)*

### Other pneumatic test ports

#### Other pneumatic test ports

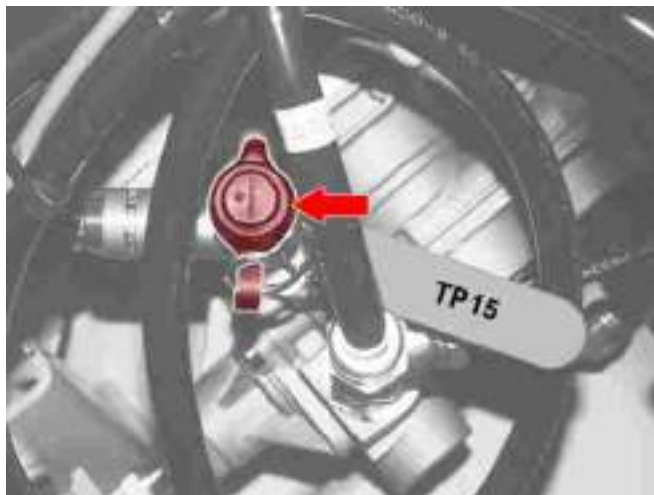

## Charging the compressed-air system of another bus

- TP 15 Brake pressure regulated on the left-hand side of the driven axle (at the axle modulator of the driven axle, port 21)
- Door 2 Pneumatic test port



**Note:**

This test port is located on the door valve in the step of the doorway of door 2.

### Charging the compressed-air system of another bus



**Note:**

Compressed air cannot be drawn off unless the pressure regulator is in the fill position.

- ▶ If the pressure regulator has been deactivated (idle position - blows into the open air), reduce the pressure in the compressed-air system by operating the pedal-operated brake valve until the pressure regulator switches on again (fill position).



M42\_00-0104-01

- ▶ Charging hose (1) can be used to charge the compressed-air system of another bus by connecting it to tyre inflator connection (4), which is located in the engine compartment.



**Danger.**

The bus must not be driven under any circumstances if the charging hose is still connected.

### Charging the compressed-air system of another bus

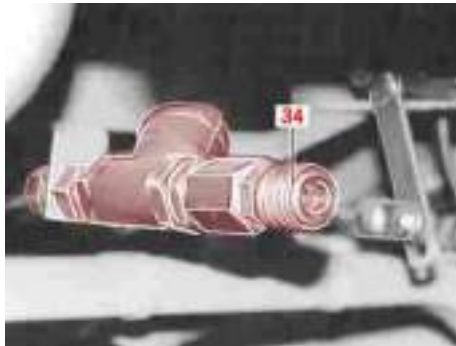

M42\_00-0105-01

- ▶ Charging by nipple connector



#### Note:

Option 1: compressed-air connection by means of nipple connector (1/2") (34) behind the front flap and in the engine compartment

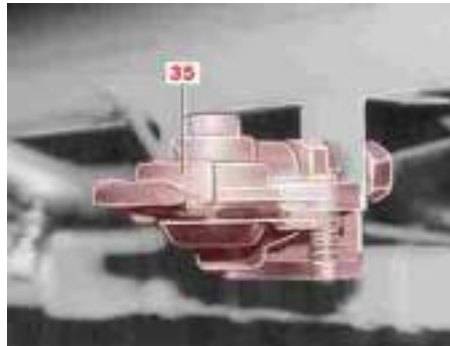

M42\_00-0106-01

- ▶ Charging by coupling head



#### Note:

Option 2: compressed-air connection by means of coupling head (35) behind the front flap and in the engine compartment



#### Note:

Using an adapter hose suitable for whichever type of connection is fitted to the bus, it is possible to charge the compressed-air system of the bus or of another vehicle.



#### Caution:

Do not charge the other vehicle's compressed-air system beyond the cutoff pressure of this vehicle's pressure regulator.

Operating the bus stop brake emergency release switch

Operating the bus stop brake emergency release switch



**Danger.**

This switch has a tamper-evident seal and is intended to be operated only in the event of a malfunction in the bus stop brake or drive-off lock.

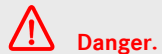

**Danger.**

Make absolutely sure that the parking brake is applied before you operate the bus stop brake emergency release switch. The bus could otherwise roll away.

- ▶ Remove the tamper-evident seal



M68\_00-0311-71

- ▶ Open red cover (1) on the emergency release switch.
- ▶ Operate switch (2) by pulling it out.  
The bus stop brake function is no longer active.



**Danger.**

Have the malfunction rectified as soon as possible by an OMNIplus Service Partner.

Electrical system safety precautions



M54.00-2004-71

For safety reasons, always switch off the battery isolating switch (01S01) before work is carried out on the electrical system or the batteries are disconnected/reconnected. This is located behind the flap above the front axle on the left-hand side when viewed in the direction of travel.

Do not connect or disconnect wiring harness connectors to/from electronic control units unless the ignition starter switch is OFF.

### Safety precautions for handling batteries

During engine washes, always protect the starter, alternator and electrical plug connections from moisture.

Never attempt to bridge or repair fuses.

Use only fuses of the specified amperage. Never replace fuses with those of a higher ampere rating as this could lead to damage to the electrical system.

#### Safety precautions for handling batteries



M54\_10-0004-01

(1) - Fire, sparks, naked flames and smoking are forbidden. Prevent sparking.

(2) - Risk of explosion.

(3) - Observe the operating instructions.

(4) - Risk of acid burns. Battery acid is corrosive. Always observe the safety instructions and safety precautions when handling batteries or battery acid. Battery acid must never come into contact with skin, eyes or clothing. Rinse off all acid splashes immediately with copious

amounts of clean water. Seek medical attention if necessary.

(5) - Wear safety goggles.

(6) - Keep children away.



**Danger.**

Naked flames and smoking are strictly forbidden whenever work is being carried out on the vehicle batteries. Avoid the creation of sparks. Wear safety goggles. Keep children away. There is a risk of acid burns. The Operating Instructions must be observed. There may be a risk of explosion.



**Danger.**

Only lead-acid batteries are permitted to be fitted, never gel batteries. All cells of the batteries must be fitted with special caps that are interlinked by vent hoses, thereby allowing any gases produced to be directed into the open air.



## Measures required for the prevention of damage to buses or components during electric welding work



### Danger.

Risk of short circuit. Do not place any metal objects on batteries.



### Caution:

Do not loosen or disconnect the terminals when the engine is running and electrical equipment is switched on.



### Environmental protection

Dispose of defective batteries in an environmentally responsible manner. Observe legal requirements.

### Measures required for the prevention of damage to buses or components during electric welding work

To prevent damage to various components of the bus, the following measures must be taken before undertaking welding work:

- Have a fire extinguisher on standby.
- The clamp on the negative terminal of the battery must be disconnected and the negative terminal covered. (Observe the notes on disconnecting the vehicle batteries.)
- The pieces of foam fitted in some of the cavities in the body as sound-proofing must be removed before the commencement of panel work, welding and tin-plating.
- Connect the earth connection of the electric welder directly to the part to be welded. When doing so, make sure that there are no electrically insulating parts between the earth connection and the weld point.
- Heat-sensitive parts, such as plastic tubes, are to be protected or removed.
- Lines routed in cavities, and containers or electronic components that have been fitted concealed, must be removed from the danger area before the start of welding.
- The passenger compartment and glazing must be covered with protective mats to protect them from weld splatter and flying sparks.
- Shield off areas at risk of damage caused by flying sparks and radiant heat.
- Do not allow the electronics housing or electrical lines to come into contact with the welding electrode or the earth connection of the welder.
- If two parts are to be welded together, both parts must be connected to the negative clip of the welder.
- The seam points of the part on the bus to be welded and of the earth terminal on the electric welder must be as bare as possible – paint, cor-

### Measures required for the prevention of damage to buses or components during electric welding work

rosion, oil, grease and dirt should therefore be thoroughly removed.

- The earth terminal of the welder must not be connected to the transmission. The welding current may cause sparking at the bearing points inside the transmission. The resultant changes in crystalline structure would lead to premature failure of the assembly.



#### **Danger.**

The heating effects may cause dense smoke or fires.



## Practical advice

Electrical system (illustration shows TRAVEGO 2-axle model as an example)

Electrical system (illustration shows TRAVEGO 2-axle model as an example)

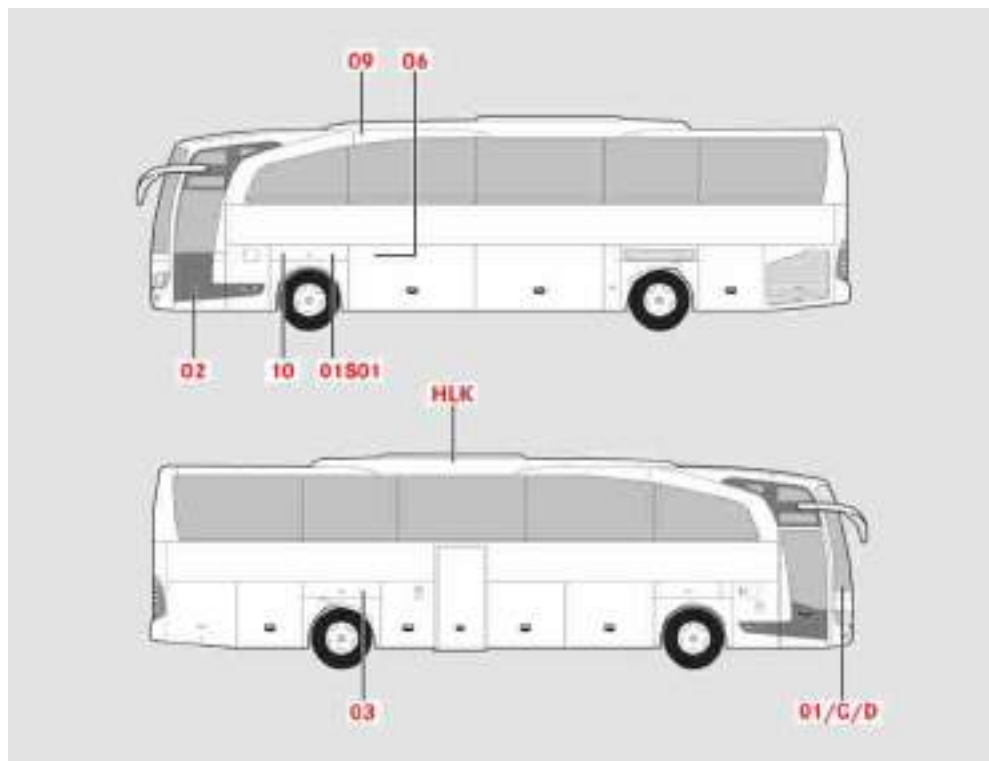

Electrical system (illustration shows TRAVEGO 2-axle model as an example)

01/C/D Driver's area interior switch panel, diagnostics connection, electrical system vehicle data CD



**Note:**

A detailed layout of electrical components (control units, fuses, relays and connectors, etc.) can be found on the electrical system vehicle data CD.

01S01 Battery isolating switch



**Note:**

On the TRAVEGO M/TRAVEGO L (3-axle) on the left-hand side at the rear above the trailing axle.



**Caution:**

Before operation, always observe the instruction label.

02 Main switch panel (under the driver's area)

03 Auxiliary switch panel



**Note:**

On the TRAVEGO M/TRAVEGO L (3-axle) on the right-hand side at the rear above the trailing axle.

06 Power distribution board (PDB)



**Note:**

On the TRAVEGO M/TRAVEGO L (3-axle) located on the auxiliary switch panel on the right-hand side at the rear above the trailing axle.

09 Ceiling switch panel

10 Battery compartment



**Note:**

On the TRAVEGO M/TRAVEGO L (3-axle) on the left-hand side at the rear above the trailing axle.

HLK Electrical connection for the roof-mounted system (heating, ventilation, air-conditioning)

## Practical advice

### Battery isolating switch (with switch-off authorisation LED)

Battery isolating switch (with  
switch-off authorisation LED)



- 01S01 Battery isolating switch  
1 Switch-off authorisation LED

**Caution:**

If this LED is lit, it is prohibited to turn the battery isolating switch to the “OFF” position. Otherwise, the exhaust gas aftertreatment system could be damaged.

### Driver's area interior switch panel

Driver's area interior switch panel





## 1 Diagnostics socket

**Note:**

This switch panel also houses fuses for consumers in the front section of the bus.

**Note:**

The cover of the driver's area switch panel also houses the electrical system vehicle data CD. This CD must remain in the bus since it contains important bus-specific data necessary for maintenance and service work.

## Practical advice

### Main switch panel (under the driver's area)

Main switch panel (under the driver's area)

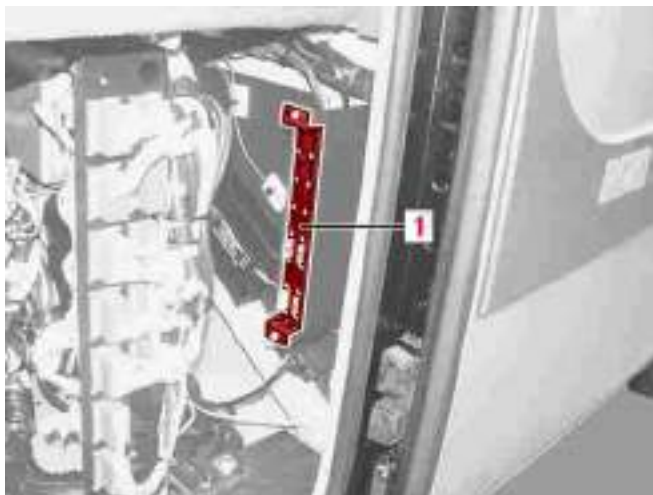

## 1 Main switch panel

**Note:**

Various electronic control units such as the EBS, retarder, etc., are located here. Various fuses (1) are also found here.

**Note:**

The release handle is located on the floor of the bus to the left-hand side of the driver's seat.

### Auxiliary switch panel

Auxiliary switch panel

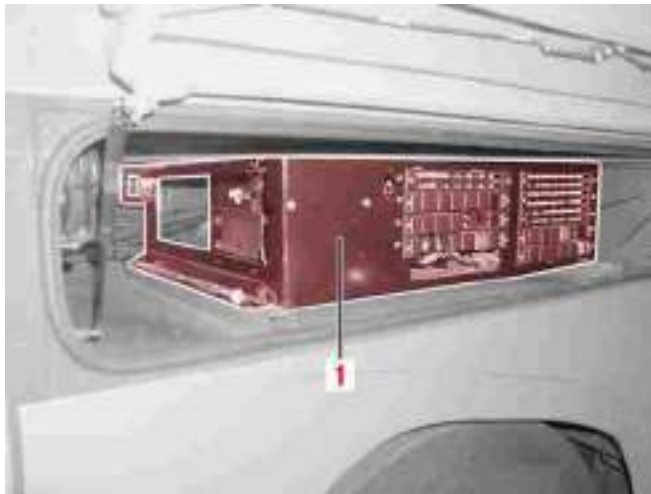



**Note:**

Auxiliary switch panel (1) also houses fuses for consumers in the rear section of the bus. The auxiliary switch panel is located above the driven axle or the trailing axle on the right-hand side.



**Note:**

In 3-axle buses, the PDB (Power Distribution Board) is also mounted here.

### Ceiling switch panel

Ceiling switch panel





**Note:**

There are also various fuses located on the ceiling switch panel for consumer units in the ceiling. This is located in the ceiling duct on the front left.

## Practical advice

### Electrical connection for the roof-mounted system (heating, ventilation, air-conditioning)

Electrical connection for the roof-mounted system (heating, ventilation, air-conditioning)

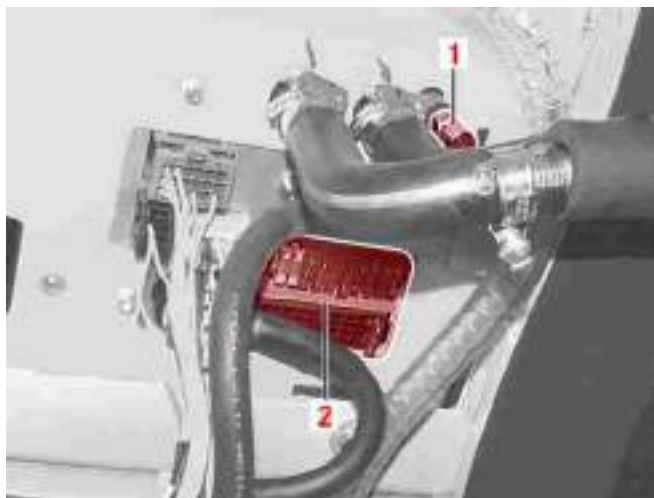



## Electrical connection for the roof-mounted system (heating, ventilation, air-conditioning)

**Note:**

The electrical connection for the roof-mounted system is located on the right-hand side in the area above door II or above the on-board kitchenette. This area is only accessible from the passenger compartment.

**Note:**

Various consumers for the roof-mounted system, such as the condenser blower, passenger compartment blower, etc., are protected by the fuses here (2).

## Practical advice

### Battery compartment

#### Battery compartment

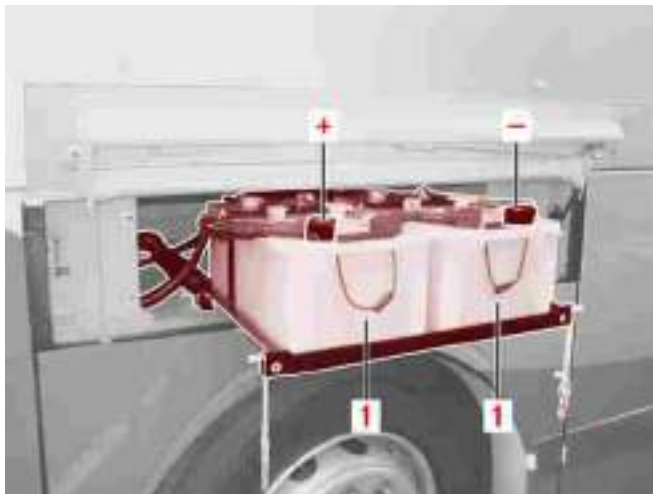

**Note:**

On 2-axle buses, the battery compartment is located above the front axle at the front on the left-hand side. On 3-axle buses, the battery compartment is located on the left-hand side above the trailing axle.

**Notes on fuse assignments**

The following information in respect of fuse assignments should be observed:

**Note:**

This description is based on the standard assignment of fuses in the bus. Bus-specific assignment may differ from bus to bus. Not all fuse slots necessarily have to be assigned on every bus. Furthermore, fuses may occupy unassigned slots because they are protecting special customer options or retrofitted equipment, for example.

**Note:**

The bus-specific fuse assignment and fuse ratings can be found on the vehicle data CD located in the driver's area interior switch panel.

## Practical advice

### Fuse assignment for driver's area interior switch panel

Fuse assignment for driver's area interior switch panel

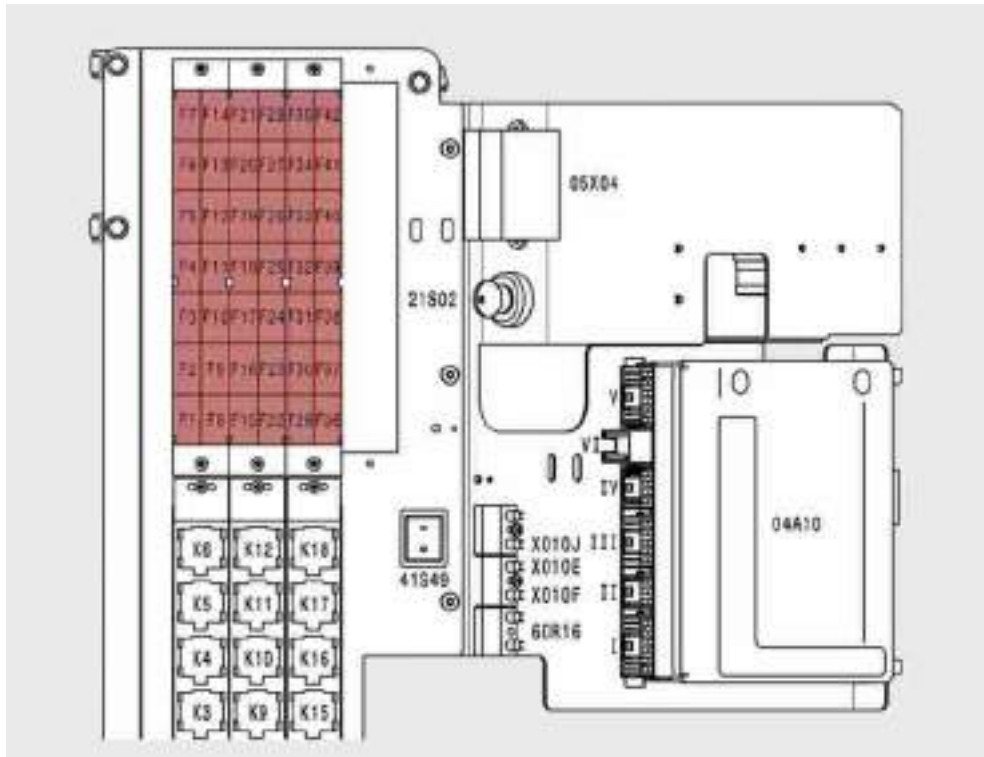

Fuse assignment for driver's area interior switch panel

|     |   |     |   |     |  |
|-----|---|-----|---|-----|--|
| F1  | 7.5 A - Distance sensor (10F28)                 | F16 | 7.5 A - AdBlue® supply unit (17F09)                         | F32 | 15 A - AdBlue® supply unit terminal 30 (17F08)                         |
| F2  | 7.5 A - 24 V socket (02F28)                     | F17 | Not assigned  | F33 | 15 A - HVAC heating/ventilation/air-conditioning control panel (50F01) |
| F3  | 7.5 A - Co-driver's reading lamp (31F01)        | F18 | 15 A - Driver's seat terminal 15 (81F01)                    | F34 | Not assigned   |
| F4  | 7.5 A - Gangway lighting (31F24)                | F19 | 7.5 A - Driver's seat vibration motor supply (81F06)        | F35 | 20 A - Radio (audio) system terminal 30 (70F20)                        |
| F5  | 5 A - Steering column adjustment (22F09)        | F20 | 25 A - Fuel pump (15F15)                                    | F36 | 7.5 A - Driver's seat terminal 30 (81F02)                              |
| F6  | 7.5 A - Mirror adjustment (32F05)               | F21 | 15 A - 24 V socket (02F07)                                  | F37 | 15 A - Cornering lamps actuation module (30F19)                        |
| F7  | 7.5 A - Driver's window heating (32F07)         | F22 | 15 A - Video monitor (70F03)                                | F38 | 5 A - Telematics system terminal 30 (77F02)                            |
| F8  | 55 A - Wiper (33F02)                            | F23 | 5 A - Trailing axle terminal 30 (22F08)                     | F39 | Not assigned   |
| F9  | 5 A - Telematics system (77F01)                 | F24 | 5 A - Microphone (70F3)                                     | F40 | Not assigned   |
| F10 | 15 A - Front box (50F02)                        | F25 | 5 A - Front destination display (71F05)                     | F41 | 3 A - Tyre pressure monitor terminal 30 (65F14)                        |
| F11 | 5 A - Telephone, radio (communications) (72F09) | F26 | 5 A - Telephone, radio (communications) terminal 15 (72F09) | F42 | 3 A - Steering angle sensor terminal 30 (20F10)                        |
| F12 | 7.5 A - C3 signal l-module/satellite (60F01)    | F27 | Not assigned  |     |  |
| F13 | Not assigned                                    | F28 | 7.5 A - Accident data recorder (60F06)                      |     |  |
| F14 | 7.5 A - 12 V power supply (01F16)               | F29 | 15 A - Voltage converter 24/12 V (01F18)                    |     |  |
| F15 | 7.5 A - Fuel level sensor (65F08)               | F30 | 7.5 A - Diagnostics/download terminal 30 (01F18)            |     |  |
|     |   | F31 | 5 A - Central gateway (05F03)                               |     |  |

## Practical advice

### Fuse assignment for main switch panel (under the driver's area)

Fuse assignment for main switch panel (under the driver's area)

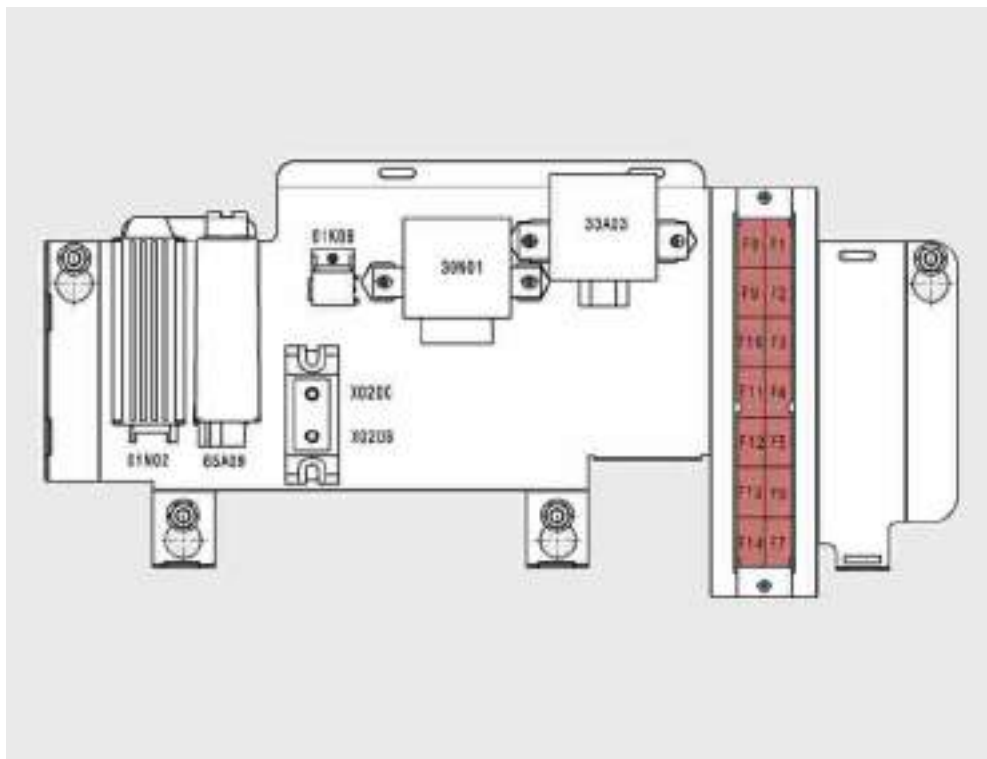

## Fuse assignment for main switch panel (under the driver's area)

|     |  |
|-----|--|
| F1  | Not assigned                                 |
| F2  | 7.5 A - Video surveillance system (70F06)    |
| F3  | Not assigned                                 |
| F4  | 7.5 A - 12 V video system (70F10)            |
| F5  | 5 A - 12 V video system terminal 15 (70F32)  |
| F6  | 15 A - 12-volt socket terminal 15 (02F08)    |
| F7  | 15 A - 12-volt socket terminal 30 (02F37)    |
| F8  | Not assigned                                 |
| F9  | 7.5 A - Parking aid (70F07)                  |
| F10 | Not assigned                                 |
| F11 | Not assigned                                 |
| F12 | Not assigned                                 |
| F13 | 5 A - 12 V video system terminal 30 (70F33)  |
| F14 | 7.5 A - LIN/CAN gateway control unit (33F05) |

## Practical advice

### Fuse assignment for auxiliary switch panel

Fuse assignment for auxiliary switch panel

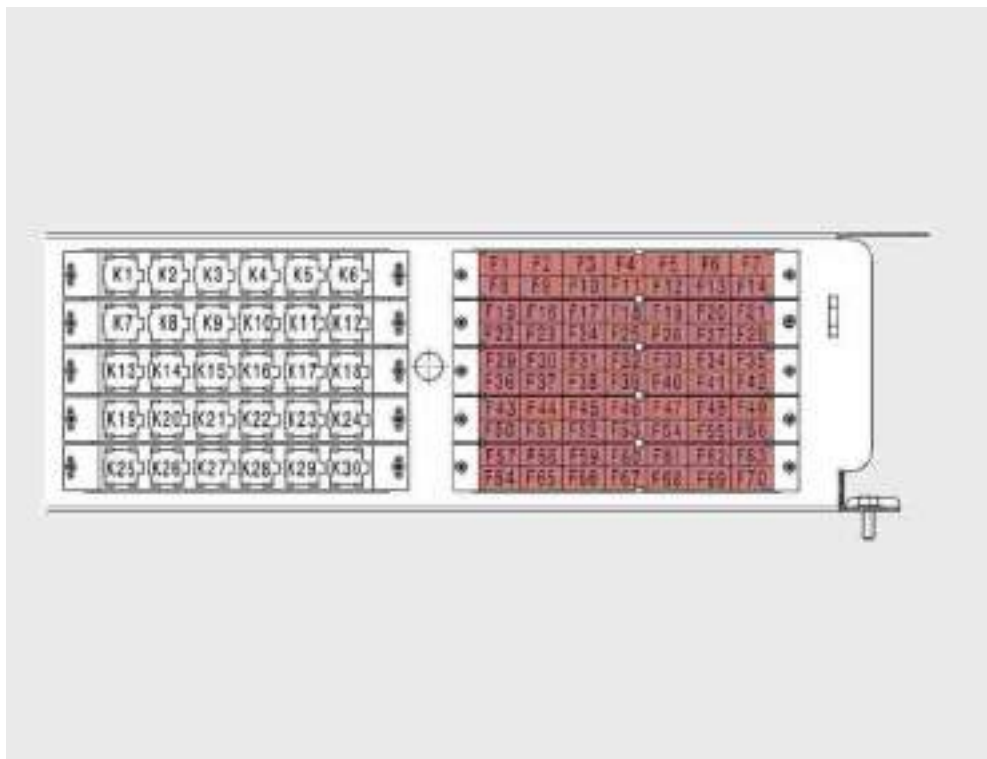



Fuse assignment for auxiliary switch panel

|     |   |     |  |     |   |
|-----|---|-----|--|-----|---|
| F1  | Not assigned  | F16 | Not assigned   | F32 | 7.5 A - Retarder terminal 30 (14F03)                                  |
| F2  | 7.5 A - Alternators terminal 15 (01F55)                               | F17 | Not assigned   | F33 | Not assigned  |
| F3  | Not assigned  | F18 | Not assigned   | F34 | Not assigned  |
| F4  | 7.5 A - Automated manual transmission terminal 15 (12F03)             | F19 | 7.5 A - Lavatory (80F05)                                 | F35 | 10 A - Electronic air-processing unit EAPU terminal 30 (24F03)        |
| F5  | 5 A - Retarder terminal 15 (14F02)                                    | F20 | 15 A - Inverter in lavatory (80F26)                      | F36 | Not assigned  |
| F6  | 25 A - Fuel pump (15F15)  | F21 | Not assigned   | F37 | Not assigned  |
| F7  | 3 A - Fuel pump switch (15F16)  | F22 | 7.5 A - Driver's rest area (81F04)                       | F38 | Not assigned  |
| F8  | Not assigned  | F23 | 7.5 A - Driver's day-bed in multi-purpose room (81F05)   | F39 | 7.5 A - Exhaust gas aftertreatment control module terminal 30 (17F11) |
| F9  | 7.5 A - Exhaust gas aftertreatment control module terminal 15 (17F10) | F24 | Not assigned   | F40 | Not assigned  |
| F10 | Not assigned  | F25 | Not assigned   | F41 | Not assigned  |
| F11 | 10 A - Electronic air-processing unit EAPU terminal 15 (24F02)        | F26 | Not assigned   | F42 | Not assigned  |
| F12 | 5 A - Engine management terminal 15 (10F50)                           | F27 | Not assigned   | F43 | 7.5 A - Substation 1 (51F30)  |
| F13 | 7.5 A - Blower motor, entry 2 (53F10)                                 | F28 | 7.5 A - 24 V socket on auxiliary switch panel (02F29)    | F44 | 7.5 A - Substation 0 (51F35)  |
| F14 | Not assigned  | F29 | 7.5 A - Engine compartment and lighting socket (02F04)   | F45 | 7.5 A - Sidewall heater 1 (53F01)                                     |
| F15 | Not assigned  | F30 | 15 A - Automated manual transmission terminal 30 (12F04) | F46 | 7.5 A - Sidewall heater 2 (53F02)                                     |
|     |   | F31 | 15 A - Automated manual transmission terminal 15 (12F05) | F47 | 7.5 A - Sidewall heater 3 (53F03)                                     |

### Fuse assignment for auxiliary switch panel

|     |  |     |  |
|-----|--|-----|--|
| F48 | 7.5 A - Sidewall heater 4 (53F04)                    | F62 | 5 A - Standalone multiplex system SMUX (04F36) |
| F49 | 15 A - Roof mixing circuit pump (53F16)              | F63 | 5 A - Instrument cluster (61F03)               |
| F50 | 15 A - Lavatory, winter-proofed (80F10)              | F64 | 15 A - Lighting strip (31F05)                  |
| F51 | Not assigned   | F65 | 15 A - Lighting strip (31F06)                  |
| F52 | 15 A - Heater for heating-oil filter (54F05)         | F66 | 20 A - Auxiliary heating unit (54F01)          |
| F53 | 5 A - Modular switch field (61F02)                   | F67 | 20 A - Auxiliary heating unit (54F02)          |
| F54 | 5 A - Electronic ignition switch terminal 30 (08F06) | F68 | 15 A - Central locking (82F01)                 |
| F55 | Not assigned   | F69 | 7.5 A - Alternator voltage sensor (01F20)      |
| F56 | Not assigned   | F70 | 5 A - Tachograph (60F07)                       |
| F57 | 5 A - Multiplex system MUX 1 (04F27)                 |     |  |
| F58 | 5 A - Multiplex system MUX 2 (04F28)                 |     |  |
| F59 | 5 A - Multiplex system MUX 3 (04F29)                 |     |  |
| F60 | 5 A - Multiplex system MUX 4 (04F30)                 |     |  |
| F61 | 5 A - Multiplex system MUX 5 (04F31)                 |     |  |



## Practical advice

### Power distribution board (PDB) fuse assignment on auxiliary switch panel

Power distribution board (PDB)  
fuse assignment on auxiliary switch  
panel

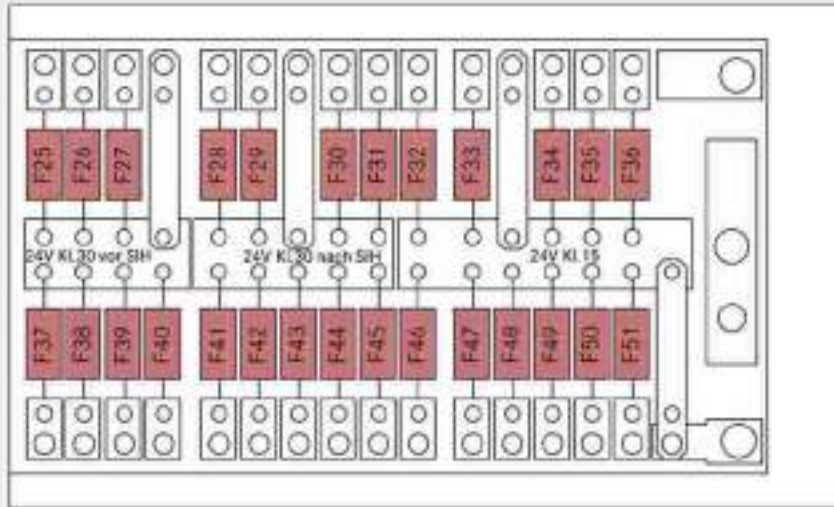

Power distribution board (PDB) fuse assignment on auxiliary switch panel

|     |  |     |  |
|-----|--|-----|--|
| F25 | 50 A - Multiplex system<br>MUX1 (04F18)      | F41 | 30 A - Exhaust gas aftertreatment control module (ACM) terminal 30 (17F11) |
| F26 | 50 A - Multiplex system<br>MUX2 (04F19)      | F42 | 30 A - Engine management main fuse (01F10)                                 |
| F27 | 50 A - Multiplex system<br>MUX3 (04F20)      | F43 | 100 A - Main fuse terminal 30 (01F07)                                      |
| F28 | Not assigned                                 | F44 | 100 A - Main fuse terminal 30 (01F13)                                      |
| F29 | Not assigned                                 | F45 | Not assigned   |
| F30 | Not assigned                                 | F46 | Not assigned   |
| F31 | 50 A - Control units terminal 30 (08F05)     | F47 | 80 A - Terminal 15 (01F17)   |
| F32 | Not assigned                                 | F48 | 50 A - Main fuse terminal 15 (01F02)                                       |
| F33 | Not assigned                                 | F49 | 150 A - Inverter (01F47)   |
| F34 | 50 A - Kitchenette (80F01)                   | F50 | 150 A - Air-conditioning system (51F01)                                    |
| F35 | 70 A - Kitchenette (80F02)                   | F51 | Not assigned   |
| F36 | 70 A - Microwave/hot water dispenser (80F03) |     |  |
| F37 | 50 A - Multiplex system<br>MUX4 (04F21)      |     |  |
| F38 | 50 A - Multiplex system<br>MUX5 (04F22)      |     |  |
| F39 | 50 A - Standalone multiplexer (SMUX) (04F37) |     |  |
| F40 | Not assigned                                 |     |  |

## Practical advice

### Fuse assignment for ceiling switch panel

#### Fuse assignment for ceiling switch panel

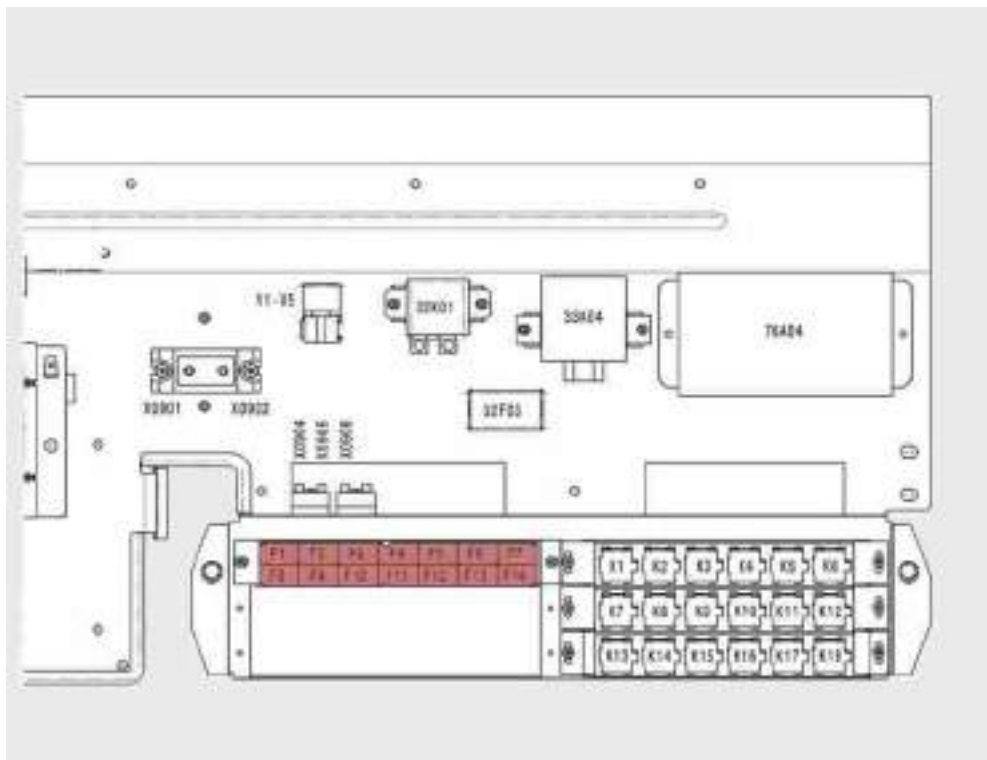

Fuse block A

- F1*      *Not assigned*
- F2*      *15 A - Reading lamps (31F03)*
- F3*      *15 A - Reading lamps (31F04)*
- F4*      *15 A - Wipers, upper (33F07)*
- F5*      *5 A - Rain sensor for roof hatch (52F04)*
- F6*      *7.5 A - Clock, terminal 15 (65F02)*
- F7*      *7.5 A - Door 2 doorway lighting (42F02)*
- F8*      *15 A - Electrically folding exterior mirrors (32F12)*
- F9*      *5 A - Video system (70F11)*
- F10*     *7.5 A - Navigation system terminal 15 (76F01)*
- F11*     *Not assigned*
- F12*     *Not assigned*
- F13*     *5 A - Video system terminal 30 (70F24)*
- F14*     *5 A - Roof hatches 1 and 2 (52F01)*

Fuse box B

- 32F03*   *40 A - Fuse for heated wind-screen*

## Practical advice

### Fuse assignment for roof-mounted heating, ventilation and air-conditioning system (Spheros)

Fuse assignment for roof-mounted heating, ventilation and air-conditioning system (Spheros)

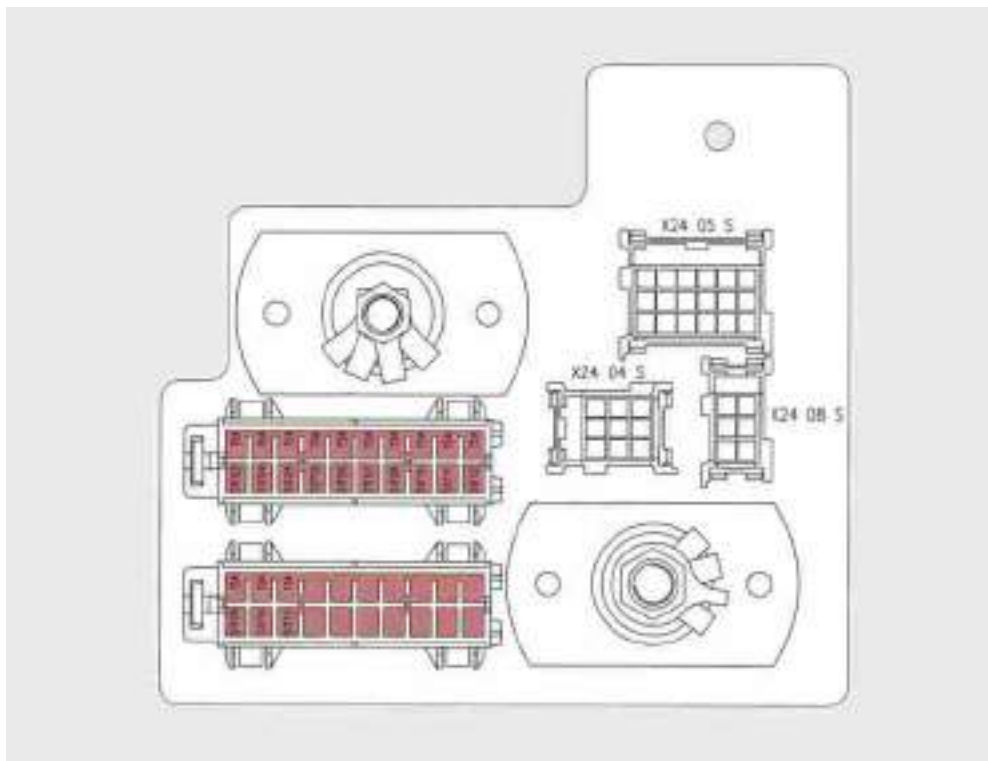



- 51F03 15 A - Fuse for evaporator blower, left
- 51F04 15 A - Fuse for evaporator blower, left
- 51F05 15 A - Fuse for evaporator blower, left
- 51F06 15 A - Fuse for evaporator blower, right
- 51F07 15 A - Fuse for evaporator blower, right
- 51F08 15 A - Fuse for evaporator blower, right
- 51F09 15 A - Fuse for condenser blower
- 51F10 15 A - Fuse for condenser blower
- 51F11 15 A - Fuse for condenser blower
- 51F12 15 A - Fuse for condenser blower
- 51F13 15 A - Fuse for condenser blower
- 51F14 15 A - Fuse for evaporator blower, left
- 51F15 15 A - Fuse for evaporator blower, right



**Note:**

All fuses in the roof-mounted heating, ventilation and air-conditioning system are accessible from the vehicle interior.

**Handling fuses**

- ▶ Always carry some spare fuses in the bus for emergencies.



**Caution:**

Fuses provide protection against excessive current loads (impermissible heating of the wires) in the electrical system.



**Note:**

There are fuses located on the driver's area interior switch panel (01), on the switch panel under the driver's area (02), on the auxiliary switch panel (03) and on the ceiling switch panel (09), as well as in the roof-mounted heating, ventilation and air-conditioning system in the ceiling duct above the WC. Additionally, on power distribution board (PDB) (06).

### Disconnecting vehicle batteries



M54.00-2004-71

- ▶ These notes must be observed without fail.



**Danger.**

Make sure that you correct the cause of the short circuit before you change a blown fuse. Make sure that connections have good contact.



**Danger.**

Never attempt to bridge or repair fuses.



**Danger.**

Use only fuses of the specified amperage. Never replace fuses with those of a higher ampere rating as this could lead to damage to the electrical system.



**Danger.**

Always switch the battery isolating switch (01S01) to OFF before work is carried out on the electrical system.

### Disconnecting vehicle batteries

- ▶ Switch off the engine.



M54.00-2004-71

- ▶ Switch battery isolating switch (01S01) to OFF.



**Danger.**

There is a risk of explosion from the ignition of oxyhydrogen gas by separation sparks at the time of battery disconnection. Battery isolating switch (01S01), which bears a warning label to this effect, is designed to rule out this risk of injury.



**Danger.**

Switch the battery isolating switch to the OFF position (key can be removed) before working on parts of the vehicle electrical system, especially the batteries. The battery isolating switch interrupts the main line from the positive terminal of the battery to the entire vehicle electrical system; for this reason, it must not be switched off until the ignition starter switch has been switched to OFF and the water heater's run-on period has ended (risk of overheating).

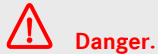

**Danger.**

Only lead-acid batteries are permitted to be fitted, never gel batteries. All cells of the batteries must be fitted with special caps that are interlinked by vent hoses, thereby allowing any gases produced to be directed into the open air.

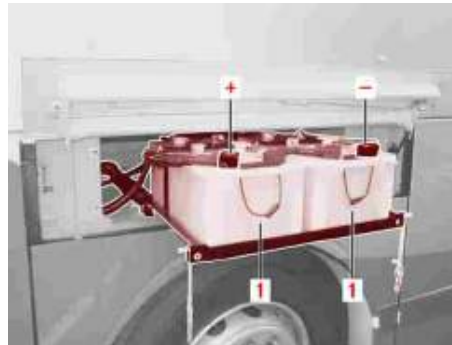

M54\_00-0904-01

- ▶ Remove the negative terminal clamp from the battery.
- ▶ Remove the positive terminal clamp from the battery.
- ▶ Reconnect the batteries in reverse order.

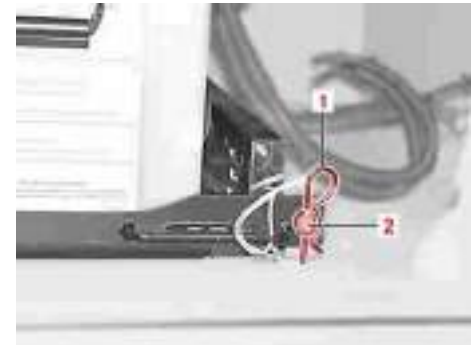

M54\_00-0839-01

- ▶ Push the battery carriage back in as far as the stop until pins (2) with a hole in the side are revealed, and then secure using two split pins (1) on the left- and right-hand side.



**Danger.**

Risk of entrapment and crushing of fingers. To slide the battery carriage in, push on the batteries with both hands. Do not push on the frame on the outside.

### Recharging vehicle batteries



#### **Danger.**

Securing split pins (1) for the battery carriage must always be fitted on both the left- and right-hand side to prevent the batteries from working their way out while the bus is in motion.

#### Recharging vehicle batteries



#### **Note:**

Recharge out-of-service batteries once a month.

- ▶ Connect the charger.



#### **Danger.**

Risk of explosion from oxyhydrogen gas formation. Make sure that the area is well ventilated when you are recharging the vehicle batteries.



#### **Note:**

Check that the charging voltage (24 or 12 V) and charging current (approximately 1/10 of the rated capacity, e.g. 200 Ah battery with 20 A charging current) are correct.

- ▶ Switch off the charger after charging has finished.



#### **Danger.**

Do not disconnect the connection terminals until the gases have stopped escaping from the battery (wait a few minutes).

## Switching to the auxiliary batteries (starter batteries) (option)

### Switching to the auxiliary batteries (starter batteries) (option)

 **Note:**

To ensure reliable starting of the engine after the bus has been parked for long periods with electrical consumers switched on, the supply of power can be switched to the auxiliary batteries for a limited time.

- ▶ Press and hold the pushbutton with the ignition starter switch ON.



The LED in the pushbutton lights up.

 **Note:**

Power is supplied from the auxiliary batteries for as long as the pushbutton is kept pressed.

- ▶ Start the bus in the normal way.
- ▶ Release the pushbutton.  
The LED in the pushbutton goes out.

 **Note:**

The auxiliary batteries are disconnected from the on-board power supply again to prevent them from being discharged.

### Notes on jump-starting

- ▶ Follow the instructions for the jump-start procedure.



**Caution:**

Before you connect the jump leads, check that the operating voltage (24 V) and polarity are the same.



**Caution:**

Only jump leads (cable cross-section approximately 70 mm<sup>2</sup>) are permitted to be used as a starting aid – never use a rapid charger. Comply with the safety regulations.



**Caution:**

Use only jump leads that have insulated terminal clips.

### Jump-start procedure



#### Note:

A discharged battery can freeze at temperatures below -10 °C. It must be thawed before the jump-start operation.



#### Danger.

Risk of acid burns. Do not lean over the battery during the jump-start procedure.

### Jump-start procedure

- ▶ Switch the ignition starter switch to OFF. Remove the ignition key.
  - ▶ Connect one end of the positive cable to the (+) terminal of the discharged battery first, then connect the other end of the positive cable to the (+) terminal of the donor battery.
  - ▶ Connect the negative cable to the (-) terminal of the donor battery, and then connect the other end of the negative cable to an earthed metal part that is bolted onto the bus skeleton.
- 
- #### Note:
- As far as possible from the discharged battery.
- ▶ Run the engine of the donor vehicle at an elevated speed.
- ▶ Start the engine of the bus to be jump-started in the normal way and let it run at idling speed.
  - ▶ Switch off the engine of the donor vehicle.
  - ▶ Fully disconnect the earth connection of the jump leads then disconnect the positive cable.



#### Note:

To prevent voltage peaks, switch on the more powerful consumers of the jump-started bus, such as the lighting, heated windows or ventilation, before you disconnect the jump leads.

## Activation and evaluation of the Integrated Diagnostics System (IDS)

### Activation and evaluation of the Integrated Diagnostics System (IDS)

**i** Note:

The Integrated Diagnostics System (IDS) cannot be regarded as a substitute for off-board diagnostics (STAR Diagnosis) because off-board diagnostics is the only means by which some functions can be monitored and tested (e.g. the channel assignment for the sensor system and actuators of the EBS or ABS/ASR system).



M68.00-0498-71

- ▶ In the “Meldungen” (Notifications) main menu, select the “Diagnose” (Diagnostics) submenu and confirm with “OK” button (1) on the steering wheel.

**i** Note:

The Integrated Diagnostics System cannot be activated unless: - bus stationary - parking brake applied - ignition starter switch ON (position 1).

**!** Danger.

All work carried out on the bus in order to rectify displayed faults must be performed by authorised personnel only.



M54.00-2012-71

- ▶ Select the desired system (in this example, ACM (2)) using the arrow buttons on the steering wheel and confirm using the “right arrow” button.

### Activation and evaluation of the Integrated Diagnostics System (IDS)



#### Note:

It is also possible to clear the fault codes of all control units at once. To do this, select “Reset aller Fehler” (Reset all faults) menu item (1) and follow the instructions.

- The following systems can be called up



#### Note:

Some systems are available only where the bus is equipped with the corresponding option.

ABA Adaptive Brake Assist

ACM Aftertreatment Control Module

ASA Additional Steering Axle

CGW Central Gateway

CLCS Chassis Level Control System

COM Communication Unit

CPC Common Powertrain Controller

DCM Door Control Module

EAPU Electronic Air Pressure Unit

EBS Electronic Brake System

ESP Electronic Stability Program

EIS Electronic Ignition Switch

HVAC Heating Ventilation Air Conditioning

ICUC Instrument Cluster Unit Common

LDW Lane Departure Warning

MCM Motor Control Module (engine)

MSF Modular Switch Field

MUX Multiplex System

RDF Radar Front End

RLS Rain Light Sensor

RCM Retarder Control Module

SAS Steering Wheel Angle Sensor

TCO Tachograph

TCM Transmission Control Module

TPM Tyre Pressure Monitoring

VRDU Video Radar Decision Unit (ART/ABA control unit)

ZV Central Locking



Activation and evaluation of the Integrated Diagnostics System (IDS)



M54.00-2013-71

- ▶ To display stored fault codes, select the relevant line (2) (highlighted blue) and confirm using “right arrow” button (3).

**i** Note:

The control unit part number (1) of the selected system is also displayed.



M54.00-2015-71

This display appears on the display screen.

**i** Note:

The fault code (1) and, in some cases, a corresponding message (2) are displayed.



M54.00-2014-71

- ▶ To clear the stored fault codes, select the relevant line (2) (highlighted blue) and confirm using “OK” button (3).
- ▶ To quit the Integrated Diagnostics System, press the “left arrow” button on the steering wheel repeatedly until the “Diagnose” (Diagnostics) submenu is displayed again.

### Changing bulbs

#### Changing bulbs



#### Note:

Bulbs and lamps are an integral part of bus safety. Make sure that all bulbs are always in working order.



#### Danger.

Bulbs can become extremely hot. There is a risk of burns. Before changing bulbs, allow them to cool off completely.



#### Danger.

Always wear safety goggles and non-slip gloves to prevent injury when changing bulbs.



#### Caution:

To prevent a short circuit, always switch off the lighting before you change a bulb.



#### Danger.

Do not use a bulb that has been dropped or has scratches on the glass. The bulb is pressurised and may explode. You could be injured by glass splinters from broken bulbs.



#### Caution:

Protect bulbs from moisture during operation and do not allow them to come into contact with fluids.



#### Caution:

Marks on the glass diminish the service life of the bulb. Do not touch the glass bulb with your bare hands. If you do, clean the glass bulb while cold using alcohol or spirit and rub dry with a lint-free cloth.



#### Note:

Bulbs must be operated only in the closed lamp units for which they are intended. Always use replacement bulbs of the same type and the correct voltage rating.



#### Note:

Check the contacts for corrosion; clean if necessary.



#### Caution:

Check the seals for correct seating; replace damaged seals with new ones.



#### Danger.

Keep children away from bulbs.



**Environmental protection**

Comply with legal requirements when you dispose of bulbs or fluorescent tubes.



**Danger.**

Gas discharge bulbs operate at high voltage, high pressure and high temperature. There is a risk of fatal injury if live parts of the lamp and ballast unit are touched. Do not touch the gas discharge bulb if the headlamp is damaged.



**Danger.**

Do not change gas discharge bulbs yourself. Always have defective gas discharge bulbs changed at a qualified specialist workshop which has the necessary specialist knowledge and tools for the work required. EvoBus recommends an OMNIplus Service Partner for this purpose.



**Danger.**

It is essential that work relevant to safety or work on safety-related systems be carried out at a qualified specialist workshop.

**Changing bulbs in the headlamps/front turn signal**

- ▶ Remove cover (quick-release lock on right).



**Note:**

The headlamp is accessible from the passenger compartment (right) or via the service cover under the driver's area (left). This cover can be opened using the handle on the left next to the driver's seat.

- ▶ When changing the turn signals, turn the bulb socket anti-clockwise and take it out. Press the bulb in, turn it anti-clockwise and remove.



**Note:**

Refit in reverse order.

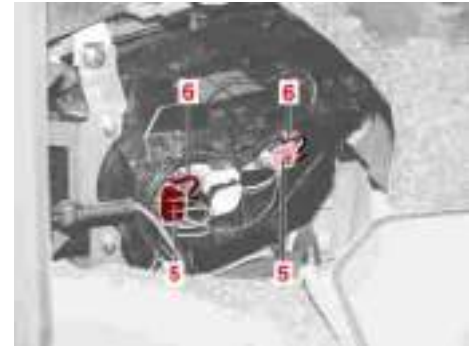

M54\_00-0102-01

- ▶ To replace the headlamp bulb, push the wire loop to the side and remove the plastic cover.
- ▶ Disconnect bulb cable (5).
- ▶ Detach retaining spring (6) and take out the bulb.

### Changing bulbs



#### Note:

Insert the new bulb so that the guides on the socket plate engage in the recesses on the headlamp mirror neck.



#### Note:

Refit in reverse order.

### Changing a front fog lamp bulb



#### Note:

The front fog lamps are accessible through the front flap (release lever located in the front right doorway).



M82\_00-0125-71

- ▶ Turn bulb holder (1) anti-clockwise and remove it.



M82\_00-0126-71

- ▶ Squeeze the locking tabs and pull connector (1) off bulb base (2).



#### Note:

Refit in reverse order.

Changing the bulb in the clearance lamp



M54\_00-0103-01

- ▶ Pull out bulb socket (7) to the rear.
- ▶ Press bulb (8) in, turn it anti-clockwise and remove.

**i** Note:

Refit in reverse order.

Changing the bulb in the side-mounted turn signal



M54\_00-0105-01

- ▶ Unscrew securing screws (3) and remove the housing.
- ▶ Press bulb (4) in, turn it anti-clockwise and remove.

**i** Note:

Refit in reverse order.

Changing a bulb in the rear lamp cluster

- ▶ Open the left or right service cover.
- ▶ Turn the base of the relevant bulb 45° anti-clockwise.
- ▶ Press the bulb in, turn it anti-clockwise and remove.

**i** Note:

Refit in reverse order.

### Changing bulbs

#### Changing a bulb in the upper rear lamp cluster



M54\_00-0677-01

- ▶ Unclip and open the left or right cover (1).



#### Note:

Cover accessible from the bus interior.



M54\_00-0678-01

- ▶ Turn base (2) of relevant lamp (3) or (4) 45° anti-clockwise.
- ▶ Press the bulb in, turn it anti-clockwise and remove.



#### Note:

Refit in reverse order.

#### Changing the bulb in the doorway lamp



M54\_00-0110-01

- ▶ Unscrew and remove two securing screws (1) and remove the lamp.
- ▶ Take out the bulb.



#### Note:

Refit in reverse order.

## Adjusting the headlamps for driving on the left or right (only in buses with bi-xenon headlamps)

### Changing the fluorescent tube of the lavatory lighting

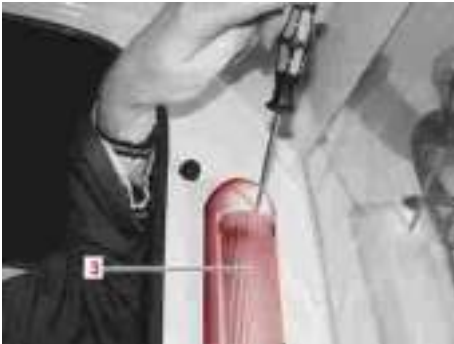

M54\_00-0114-01

- ▶ Remove cover (3) using a screwdriver.
- ▶ Turn the fluorescent tube through 90° and remove it.



**Note:**

Refit in reverse order.

### Adjusting the headlamps for driving on the left or right (only in buses with bi-xenon headlamps)



**Caution:**

In vehicles with bi-xenon headlamps, it is possible to adjust the headlamps for right-hand-drive or left-hand-drive operation. Please observe the rules and regulations of the country in which the vehicle is operated.

- ▶ Switch off the lighting.



**Danger.**

Bulbs and bulb holders may be hot and bulbs are pressurised.

- ▶ Remove the cover.



**Note:**

The headlamp is accessible from the vehicle interior (right) or via the service cover under the driver's area (left).

- ▶ Switch off the lighting.



**Danger.**

Remove the ignition key. The lighting system must be de-energised. Caution: gas discharge lamps operate at high voltages.

- ▶ Open the plastic cover by turning anti-clockwise and remove.



M82.00-0142-71

- ▶ The headlamp is adjusted with metal bar (1).

### Removing the exterior mirror, fitting the emergency mirror (option)



#### Note:

Push metal bar (1) upwards: driving on the right.



#### Note:

Push metal bar (1) downwards: driving on the left.



#### Note:

Refit in reverse order.

### Removing the exterior mirror, fitting the emergency mirror (option)



#### Note:

The emergency mirror (option) is located in the luggage compartment and can be used on either side of the bus. Tools needed for assembly: WAF 6 Allen key, screwdriver, WAF 15 open-ended spanner



#### Danger.

Always make sure that the ladder you use is suitable for the task. Secure the ladder against sliding away.



#### Danger.

The emergency mirror is for use in an emergency only and only for as long as it takes to drive to the nearest workshop.



M88\_70-0002-01

- ▶ Remove the upper cover cap from the mirror arm. To do this, push in the two quick-release locks (1) and rotate through 90° (position transverse to the direction of travel).



Removing the exterior mirror, fitting the emergency mirror (option)



M88\_70-0004-01

- ▶ Disconnect the electrical connection at connector (2). Pull retaining clip (7) outwards, twist through 30°. Loosen clamp screws (3) a few turns. If lock (8) is present (option), this will need to be unlocked. Pull mirror head (4) forwards out of mirror arm (5).
- ▶ Unscrew securing screws (10) from mirror arm (5). Remove mirror arm (5).



M88\_70-0003-01

- ▶ Unscrew securing screws (1.1) for emergency mirror (1) and remove the emergency mirror.
- ▶ Fit the emergency mirror to the attachment points on the mirror arm and tighten securing screws (10).



**Danger.**

Check the security of the emergency mirror and adjust it to the correct position.



**Danger.**

The emergency mirror reduces the size of the reflected image. Objects may in fact be closer than they appear. The emergency mirror does not feature the additional viewing panels of the standard mirror.

### Maintenance tasks for the air-conditioning system in the bus (filter maintenance)

#### Maintenance tasks for the air-conditioning system in the bus (filter maintenance)

#### Cleaning/replacing the recirculated-air filters

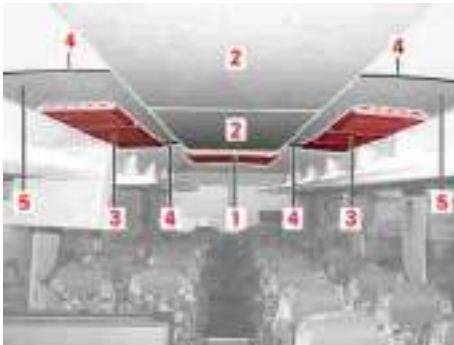

M83\_00-0505-71

- ▶ Switch the ignition starter switch to OFF.
- ▶ Cover seats and floor linings for protection.
- ▶ Remove left- and right-side recirculated-air filter cassettes (3).



#### Note:

Recirculated-air filter cassettes (3) are each secured by 4 plastic screws (quick-release locks). To open, press the screws upwards slightly and turn them through 90° anti-clockwise.



M83\_00-0423-01

- ▶ Clean or exchange filter material (2) and refit the recirculated-air filter cassettes.



#### Note:

To close, press plastic screws (1) (quick-release locks) upwards slightly and turn them through 90° clockwise.



#### Note:

Installation position: colouring (labelling) facing up.

Scopes of maintenance for the air-conditioning system

Cleaning or replacing the fresh-air/ recirculated-air filters

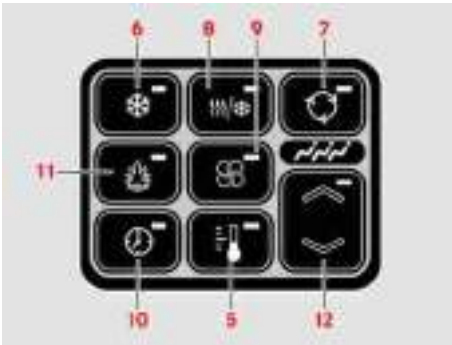

M83\_00-0117-01

- ▶ Switch the ignition starter switch to ON
- ▶ Press button (7) on the HVAC control panel and wait 10 seconds.
- ▶ Switch the ignition starter switch to OFF
- ▶ Fold down the recirculated-air filter cassettes on the left- and right-hand side.

Cleaning the fresh-air filter in the driver's area

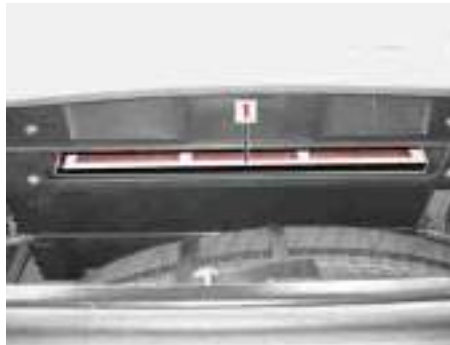

M83\_00-0796-71

- ▶ Open the spare wheel flap at the front of the bus (lever in entrance of front right door)
- ▶ Lift the fresh-air filter mat up with both hands (approximately 6 mm) and then pull it out downwards and towards you.
- ▶ Clean the fresh-air filter mat by beating out the dust, vacuuming or blasting with compressed air against the intake direction and then refit it. Exchange the filter mat if necessary.

Scopes of maintenance for the air-conditioning system

Cleaning the condenser



Note:

Check and clean condenser (4) only with the engine and air-conditioning system switched off

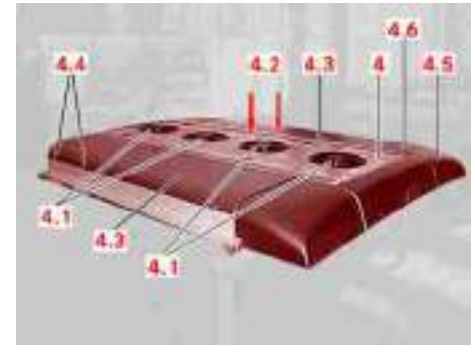

M83\_00-0105-01

- ▶ Fully unscrew condenser fans (4.1)

### Scopes of maintenance for the air-conditioning system



**Danger.**

The condenser is accessible for cleaning only from the roof. Secure the bus in stationary position so that it cannot be set in motion by an unauthorised person. Implement the necessary safeguards to prevent a fall from the roof (safety harness, scaffold, ladder, etc.).

- ▶ For normal levels of dirt, blow out the dust that has deposited in the fins with compressed air in the direction of arrow (4.2)
- ▶ For stubborn dirt, spray into the fins with a grease-dissolving substance (cold cleaner), allow it to work and then spray it off with water. Blow it dry with compressed air in the direction of arrow (4.2)



**Note:**

To prevent deformation of the fins, the jet of air or water must always be directed perpendicular (90°) to the condenser surface.

- ▶ Then check condenser fans (4.1) for correct operation: air drawn in the opposite direction to the arrow (4.2)



**Note:**

A dirty condenser causes an increase in pressure in the refrigerant system and a safety switch response (high pressure). The cleaning interval depends on the length of operation and the load to which the system is subjected.

### Carrying out the compressor maintenance program

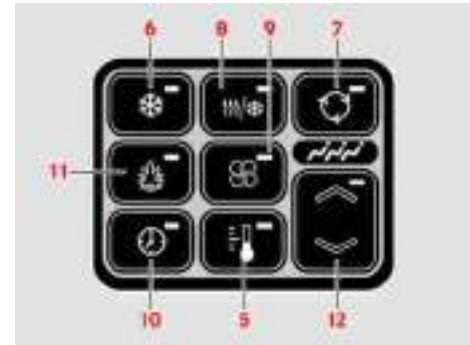

M83\_00-0117-01

- ▶ Press and hold A/C enable button (6) and rocker switch (12) on the control panel simultaneously with the ignition starter switch OFF. Switch the ignition starter switch to ON and start the engine. The LED in Smog button (7) starts to flash and the LED in button (6) lights up. The air-conditioning system is switched on after a delay of approximately 60 seconds, and the “Air-conditioning compressor in operation” symbol appears on the screen.

Scopes of maintenance for the air-conditioning system

The maintenance program is ended automatically after approximately 5 minutes and the LED in Smog button (7) stops flashing. The only way to interrupt the program prematurely is to switch off the engine (ignition starter switch OFF).

**i** Note:

To ensure that the slide ring seal on the compressor crankshaft does not dry out and start to leak, the air-conditioning system must be operated at least once a month (even in the cold season).

**i** Note:

The maintenance program for the compressor cannot be carried out unless the outside temperature is above 0 °C and the coolant temperature (engine circuit) is above 50 °C.

Checking the oil level in the refrigerant compressor



M83\_00-0106-01

- ▶ Check the inspection glass on the refrigerant compressor when the compressor is running (after approximately 10 - 15 minutes). The oil level should be between the marks (min. and max.).

**i** Note:

Refrigerator oil is circulated together with the refrigerant in the entire refrigerant system. For this reason, the oil level may differ with each check but must still be between the min. and max. marks on the inspection glass. Have underfilled refrigerator oil topped up only by the authorised specialists of an OMNIplus Service Partner.

**i** Note:

To ensure that the slide ring seal on the compressor crankshaft does not dry out and start to leak, the air-conditioning system must be operated once a month for approximately 10 - 15 minutes by pressing Reheat button (8) on the HVAC control panel. At outside temperatures of below +5 °C, the procedure should be carried out indoors otherwise the system will be switched off by the low-pressure switch or ice sensor.

### Scopes of maintenance for the air-conditioning system

#### Checking the coolant level



#### Note:

The illustration shows the SPHEROS roof-mounted system. In the KONVEKTA system, the inspection glass is also located under the rear right service cover.



M83\_00-0409-01

- ▶ Open the rear right-hand service cover on the roof



#### Danger.

Secure the bus in stationary position so that it cannot be set in motion by an unauthorised person. Implement the necessary safeguards to prevent a fall from the roof (safety harness, scaffold, ladder, etc.).

- ▶ Heat up the vehicle interior to > 26 °C
- ▶ Switch on the air-conditioning system



#### Note:

Engine speed approximately 1,500 rpm.

- ▶ Check the refrigerant level in inspection glass (6) after an operating time of 15 - 20 minutes:



#### Note:

The refrigerant must be flowing in inspection glass (8) without any bubbles.



#### Note:

Have the underfilled refrigerant topped up only by the authorised specialists of an OMNIplus Service Partner.

Bleeding the coolant circuit for the heating system

Bleeding the coolant circuit for the heating system



**Danger.**

There is a risk of scalding to skin and eyes from hot coolant spraying out. Wear protective clothing (gloves/safety goggles). Do not open the sealing cap on the coolant expansion tank unless the coolant temperature is below 50 °C. Risk of poisoning if coolant is swallowed.



**Note:**

The heating, ventilation and air-conditioning control panel features an integrated “filling program”. This program provides all the necessary functions (control of recirculation pumps and coolant valves) for filling and bleeding the heating system coolant circuit completely.



M20.00-0144-71

- ▶ Open sealing cap (2) slowly to relieve the excess pressure.

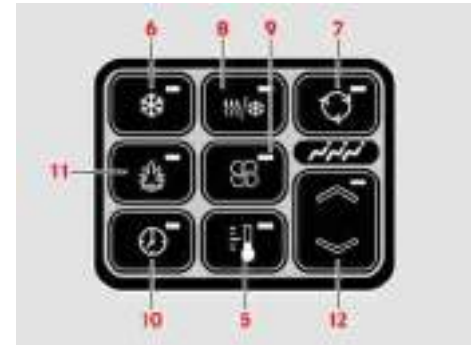

M83\_00-0117-01

- ▶ Start the filling program. The filling program is started with the ignition starter switch in the OFF position. Press and hold Smog button (7) and rocker switch (12) on the control panel simultaneously. Turn the ignition starter switch to the ON position (position 2). Keep Smog button (7) and rocker switch (12) pressed until the LEDs in buttons (6, 7, 8, 11) light up. The LED in rocker switch (12) flashes.

### Bleeding the coolant circuit for the heating system



#### Note:

The filling program is divided into 3 stages. You can switch to the next program stage using rocker switch (12). An LED on the right-hand section of the control panel goes out as each program stage is completed. There is a forced pause of 10 seconds between each stage. The pause lasts 6 minutes in stage 2. It is not possible to switch to the next stage until the forced pauses have elapsed (LED in rocker switch (12) starts to flash). From program stage 2 onwards, the engine must be running, otherwise it is impossible for the program to proceed. In program stages 2 and 3, set an elevated idling speed (approximately 750 rpm) using the retarder lever (refer to the retarder lever operating instructions).



#### Note:

The coolant level in the engine coolant expansion tank must be checked, and topped up if necessary, during and after each program stage.

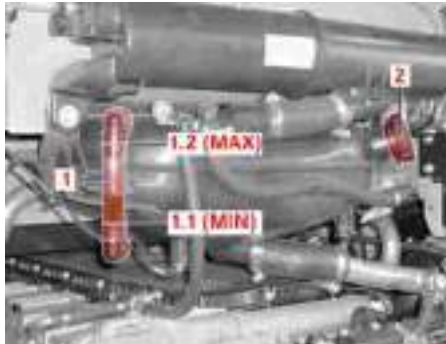

M20.00-0144-71

- ▶ Program stage 1 (LEDs in buttons 6, 7, 8, 11 light up, engine off): Add coolant through opening (2) until the expansion tank is completely filled with coolant. Press rocker switch (12) on the control panel - the LED in button (6) goes out.



#### Note:

Use clean water – well filtered and as soft as possible (drinking water quality) – mixed with corrosion inhibitor/antifreeze (comply with the Specifications for Service Products).



#### Danger.

If no corrosion inhibitor/antifreeze is available, pure water may be used temporarily (drinking quality). The bus must be driven to the nearest OMNIplus Service Partner to have corrosion inhibitor/antifreeze added to the coolant in the specified ratio (refer to the “Practical advice” section). Automatic heating/ventilation/air-conditioning mode must be disabled at the HVAC control panel (LED in the A/C button not lit) to prevent the air-conditioning system from being switched on (refer to the “Heating/ventilation/air-conditioning” section for notes on operation).



Bleeding the coolant circuit for the heating system

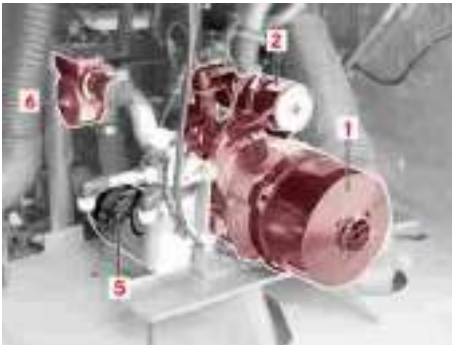

M83\_00-0403-01

- ▶ Program stage 2 (engine running at an elevated idling speed of approximately 750 rpm/duration approximately 6 minutes): Recirculation pumps (2, 5) and auxiliary heating unit (1) are switched on. Bleed the coolant circuit and fill up the coolant expansion tank completely with coolant.

 **Danger.**

Risk of injury. Take particular care around hot, rotating and moving parts.

 **Note:**

Risk of fire and burns. There is a risk of fires and burns due to the high exhaust temperatures and the hot exhaust pipe for the auxiliary heating. For this reason, do not stop or park the bus over ignitable materials (e.g. grass) when the auxiliary heating is in operation, has recently been in operation or has been operated by the instant heating button/preset timer.

 **Danger.**

Risk of poisoning and asphyxiation. The auxiliary heating must not be used in enclosed spaces such as garages or workshops due to the risk of poisoning and asphyxiation. Nor in the timer or preselection mode.

 **Danger.**

Risk of fire. The auxiliary heating must remain switched off in places where ignitable vapours or dust can accumulate (e.g. in the vicinity of filling stations, fuel depots, or coal, sawdust or grain stores or similar).

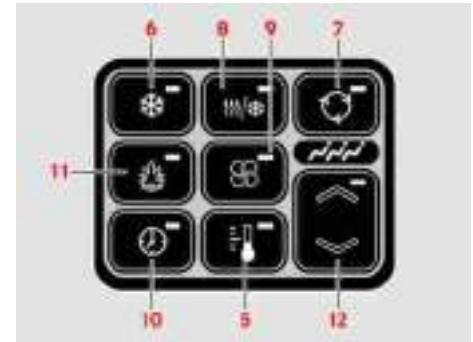

M83\_00-0117-01

- ▶ Press rocker switch (12) on the control panel - the LED in button (8) goes out. Program stage 3 (engine running at an elevated idling speed of approximately 750 rpm): The recirculation pumps and the auxiliary

### Bleeding the coolant circuit for the heating system

heating unit are switched on. Bleed the coolant circuit and fill up the coolant expansion tank completely with coolant.

- ▶ Press rocker switch (12) on the control panel - the LEDs in buttons 7 and 11 go out and the filling program is ended.

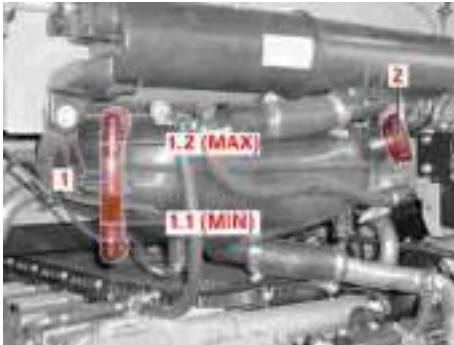

M20.00-0144-71

- ▶ Read off the coolant level and fill up to maximum mark (1.2).

|   |            |
|---|------------|
| <b>Vehicle data</b> .....               | <b>560</b> |
| <b>Overview of lighting types</b> ..... | <b>561</b> |

## Vehicle data

| Vehicle data                        |   |
|-------------------------------------|---|
| Designation                         | Value   |
| Vehicle length                      | TRAVEGO:<br>12,180 mm<br>TRAVEGO M:<br>13,000 mm<br>TRAVEGO L:<br>14,030 mm |
| Vehicle width                       | 2,550 mm  |
| Vehicle height<br>(including body)  | 3,710 mm  |
| Permissible gross<br>vehicle weight | TRAVEGO:<br>18,000 kg<br>TRAVEGO M:<br>24,000 kg<br>TRAVEGO L:<br>24,000 kg |

| Designation                | Value   |
|----------------------------|---|
| Wheelbase 1st-2nd<br>axle  | TRAVEGO:<br>6,080 mm<br>TRAVEGO M:<br>6,080 mm<br>TRAVEGO L:<br>7,110 mm    |
| Wheelbase 2nd-3rd<br>axle  | TRAVEGO M:<br>1,350 mm<br>TRAVEGO L:<br>1,350 mm                            |
| Turning circle (w to<br>w) | TRAVEGO:<br>21,110 mm<br>TRAVEGO M:<br>21,320 mm<br>TRAVEGO L:<br>23,800 mm |
| Front overhang             | 2,800 mm  |

| Designation                           | Value  |
|---------------------------------------|--|
| Rear overhang                         | TRAVEGO:<br>3,300 mm<br>TRAVEGO M:<br>2,770 mm<br>TRAVEGO L:<br>2,770 mm |
| Total fuel tank<br>volume             | TRAVEGO:<br>490 l<br>TRAVEGO M:<br>490 l<br>TRAVEGO L:<br>490 l          |
| AdBlue® additive<br>tank capacity     | TRAVEGO:<br>40 l<br>TRAVEGO M:<br>40 l<br>TRAVEGO L:<br>40 l             |
| Heating-oil tank<br>capacity (option) | 41 l   |

**Overview of lighting types**

| Designation                 | Value |
|-----------------------------|-------|
| Windscreen washer reservoir | 24 l  |

| Overview of lighting types                    |                        |
|---|------------------------|
| Designation                                   | Value                  |
| Main-beam head-lamps                          | 24V 70W H1             |
| Front foglamps                                | 12V 55W H11            |
| Dipped-beam head-lamps                        | 24V 70W H7             |
| Dipped-beam head-lamps with Litronic (option) | Gas discharge lamp D2S |
| Clearance lamps, front lower                  | 24V 5W glass base      |
| Clearance lamps, front upper                  | LED                    |
| Turn signals, front and rear lower            | 24V 21W BA15 yellow    |

| Designation  | Value                    |
|--|--------------------------|
| Turn signals rear upper, brake lamps, reversing lamps, rear foglamps | 24V 21W BA15             |
| Brake lamps/tail lamps upper   | 24V 21/5W BA15           |
| Lower tail lamps   | 24V 5W BA15              |
| Licence plate lamps  | LED                      |
| Side marker lamps  | LED                      |
| End outline marker lamps   | 24V 4W T8/4              |
| Centre aisle overhead lighting                                       | T5 F35W fluorescent tube |
| Centre aisle low-level lighting                                      | LED                      |
| Reading lamps  | 24V 10W BA15             |

### Overview of lighting types

| Designation               | Value                   |
|---------------------------|-------------------------|
| Night lighting            | LED                     |
| Service call lamp         | LED                     |
| Doorway lamps             | 24V 10W festoon         |
| Driver's area lighting    | 24V 10W halogen         |
| Luggage compartment lamps | LED                     |
| Lavatory lighting         | 24V 8W fluorescent tube |

- 2**
- 230/400 V systems (option)**  
 Safety precautions ..... 58
- A**
- Acceleration skid control (ASR)**  
 Deactivating ..... 57  
 System description ..... 52
- Accident data recorder**  
 Pushbutton ..... 85, 185
- Accident data recorder (ADR)**  
 Function description ..... 46
- Active Brake Assist** ..... 259-262  
 Activation/deactivation (automatic) ..... 255  
 Deactivating (manually) ..... 256  
 Special driving situations ... 266-269
- Active Brake Assist (ABA)**  
 System description ..... 254
- AdBlue®**  
 Service product ..... 36
- Air suspension**  
 Safety precautions ..... 160
- Air-conditioning system**  
 Operating instructions ..... 278
- Safety precautions ..... 10
- Attention Assist**  
 Function description ..... 273-275  
 System description ..... 273
- Automatic headlamp feature** ... 110
- Auxiliary batteries**  
 Switching to ..... 537
- Auxiliary heating**  
 Safety precautions ..... 11
- Auxiliary heating unit**  
 Activating ..... 288-289  
 Activating a programmed switch-on time ..... 292-293  
 Deactivating an activated switch-on time ..... 294  
 Programming switch-on times ..... 290-291  
 Programming the switch-on duration ..... 294-295
- Auxiliary switch panel** .... 512-513
- Axle load transfer** ..... 79, 163, 175
- B**
- Ball hitch trailer coupling**  
 Fixed ..... 31
- Batteries**  
 Disconnecting ..... 534-535  
 Recharging ..... 536  
 Safety precautions ..... 500
- Battery compartment** ..... 518
- Battery isolating switch** ... 506-507
- Bi-xenon headlamps**  
 Adjusting the headlamps for driving on the left or right ..... 547
- BlueTec® exhaust gas cleaning system** ..... 34-35
- Bluetooth link** ..... 155
- Brake Assist**  
 System description ..... 53
- Brake lamps**  
 Adaptive ..... 53
- Brakes with anti-locking protection** ..... 48
- Braking and stopping** ..... 48
- Bus**  
 Raising/lowering ..... 161
- Bus stop brake** ..... 184  
 Activating/deactivating ..... 164  
 Emergency release switch ..... 80, 179, 499

## C

**Care and cleaning**

- Covers, upholstery and ceiling . . . 66
- Fabric covers . . . . . 66-67
- Headlamp plastic cover lenses . . . 64
- Leather covers . . . . . 70-71
- Light-alloy wheels . . . . . 65
- Micro-fibre covers . . . . . 68-69
- Safety precautions . . . . . 62-63

**CC pump**

- Greasing the impeller . . . . . 436

**Ceiling switch panel** . . . . . 514-515**Central locking**

- Left-side luggage compartment . . . . . 79, 176
- Right-side luggage compartment . . . . . 80, 176

**Changing bulbs** . . . . . 542-546**Checking the coolant level of the engine and heating system** . . . . 468**Compressed-air system**

- Charging another bus . . . . . 497-498

**Cornering lamps** . . . . . 111**Courtesy lighting**

- Switch-off delay . . . . . 112

**Cruise control**

- Activating . . . . . 235-237

## D

**Daytime driving lights** . . . . . 110**Departure check**

- Daily tasks . . . . . 14
- Weekly tasks . . . . . 15

**Diesel particulate filter**

- Important information . . . . . 40-41
- Regeneration . . . . . 42-43

**Display screen** . . . . . 116-117

- Description . . . . . 123
- Menu structure . . . . . 124-142

**Display screen menu control****logic** . . . . . 143-144**Distance cruise control**

- Activating while the bus is in motion . . . . . 245-247
- Activating while the bus is stationary . . . . . 248-249
- Distance sensor . . . . . 241
- How to respond to a distance warning . . . . . 252
- Setting the specified distance . . 250

- Special driving situations . . . 266-269

- Vehicle ahead detected . . . . . 251

**Distance cruise control (ART)**

- Function description . . . . . 243-244

**Door pushbutton**

- Door I . . . . . 83, 179
- Door II . . . . . 83, 180

**Door pushbuttons in the****driver's area** . . . . . 90, 300**Doors**

- Anti-entrapment protection (reversing) in the door closing direction . . . . . 301
- Emergency valve operation . . 309-310
- Protection against entrapment in the door opening direction . . . . 301

**Drive belts**

- Fitting . . . . . 455-458, 463-467
- Removing . . . . . 453-454, 459-462

**Driver's area**

- Overview . . . . . 76
- Switches below the driver's window . . . . . 84-85
- Switches on the left section of the instrument panel . . . . . 77-80



- Switches on the right section of the instrument panel . . . . . 82-83
  - Driver's area intercom**
    - Incoming calls . . . . . 154
    - Outgoing calls . . . . . 152-153
  - Driver's area interior switch panel** . . . . . 508-509
  - Driver's area lighting** . . . . . 85, 183
  - Driver's power window** . . . . . 80, 178
  - Driver's rest area**
    - Overview . . . . . 96-97
    - Switches/controllers . . . . . 296-297
  - Driver's rest area/kitchenette intercom**
    - Outgoing calls . . . . . 151
  - Driver's seat**
    - Grammer . . . . . 190-191
    - ISRI 6860/875 (option) . . . 192-193
    - Safety precautions . . . . . 188
  - Driver's seat microphone** . . . 80, 179
  - Driving** . . . . . 24-25
  - Driving systems**
    - Automatic speed limiter . . . . . 225
    - Distance cruise control (option) . . . . . 239-240
    - Drive/brake cruise control . . . . 232
    - Overview . . . . . 224
    - Variable speed limiter (Temposet) 226
- E**
- Electric fuel pump** . . . . . 448
  - Electrical system**
    - Measures required for the prevention of damage . . . . . 501-502
    - Overview . . . . . 504-505
    - Safety precautions . . . . . 499
  - Electronic brake system (EBS)**
    - System description . . . . . 52
  - Electronic Stability Program (ESP)**
    - Deactivating . . . . . 57
    - Function description . . . . . 55-56
    - Pushbutton . . . . . 79, 174
    - System description . . . . . 54
  - Emergency braking** . . . . . 47
  - Emergency hammer** . . . . . 95
  - Emergency mirror**
    - Fitting . . . . . 548-549
  - Emergency valve reset** . . . . . 83, 180
  - Emergency-off switch/master safety switch** . . . . . 170
- Engine**
- Starting . . . . . 22-23
  - Stopping . . . . . 26
- Engine oil level**
- Checking with the dipstick . . . . 452
- Engine oil level display** . . . . . 448
- Event notifications** . . . . . 145
- Exterior flaps**
- TRAVEGO M / L . . . . . 100
- F**
- Fire extinguishers** . . . . . 92
  - Fire extinguishing system**
    - Description . . . . . 101
  - Fire prevention** . . . . . 9
  - First-aid kit** . . . . . 92
  - Fresh water tank**
    - Draining . . . . . 374, 413
    - Filling inside the bus . . . . . 321, 356-357, 396
    - Filling outside the bus . 322, 358, 397
  - Front foglamps** . . . . . 110
  - Fuse assignment**
    - Auxiliary switch panel . . . . . 524-526
    - Ceiling switch panel . . . . . 530-531

- Driver's area interior switch panel . . . . . 520-521
- Main switch panel (under the driver's area) . . . . . 522-523
- Roof-mounted heating, ventilation and air-conditioning system (Sferos) . . . . . 532
- Fuses**
  - Handling . . . . . 533
- H**
- Hazard warning lamps** . . . . . 83, 180
- Headlamps** . . . . . 110
- Heating/ventilation/air-conditioning**
  - Activating the air-conditioning . . . 286
  - Activating the reheat function . . . 288
  - Adjusting the blower speed in the passenger compartment . . . . . 285
  - Bleeding the coolant circuit for the heating system . . . . . 555-558
  - Control panel . . . . . 77, 280-282
  - Filter maintenance . . . . . 550
  - Manually adjusting the blower speed in the driver's area . . . . . 283
  - Preselecting the passenger-compartment temperature . . . . . 284
  - Scopes of maintenance for the air-conditioning system . . 551-554
  - Switching on air-recirculation mode in the driver's area and passenger compartment . . . . . 287
- Hillholder/bus stop brake** . . . 83, 181
- I**
- Identification plate** . . . . . 1-2
- Ignition lock** . . . . . 108
- Instrument cluster** . . . . . 86-87
- Instrument cluster display screen**
  - Operating, function and malfunction displays . . . . . 442-447
- Integrated Diagnostics System (IDS)**
  - Activation/evaluation . . . . . 539-541
- J**
- Jump seat** . . . . . 194
- Jump-starting**
  - Note . . . . . 537
  - Procedure . . . . . 538
- L**
- Lane assistant warning system**
  - Deactivating . . . . . 272
- Pushbutton . . . . . 79, 174
- Safety precautions . . . . . 270-271
- Lavatory**
  - Emptying the fresh water storage tank . . . . . 433
  - Emptying the holding tank with auxiliary pushbutton . . . . . 434
  - Enabling . . . . . 426-427
  - Switchover between water (WC) and chemical (CC) operation . . . 428
- Lavatory/audio system**
  - Enabling switch . . . . . 79, 173
- Locking** . . . . . 307-308
  - Door 1 . . . . . 306
- Luggage compartment flaps**
  - Emergency unlocking in the event of a compressed-air supply failure . . . . . 311
- M**
- Main menu** . . . . . 124-142
- Main switch panel (under the driver's area)** . . . . . 510-511
- Mirror adjuster** . . . . . 80

|                           |         |
|---------------------------|---------|
| <b>Mobile phone</b> ..... | 155     |
| Incoming calls .....      | 158     |
| Outgoing calls .....      | 156-157 |

## N

|                                    |         |
|------------------------------------|---------|
| <b>Night lighting</b> .....        | 85, 185 |
| <b>Normal level</b>                |         |
| Pushbutton .....                   | 162     |
| <b>Normal level/kneeling</b> ..... | 83, 181 |
| <b>Note symbols</b> .....          | 4       |

## O

### On-board kitchenette

|                           |                           |
|---------------------------|---------------------------|
| Checking and cleaning     |                           |
| the fresh water filter .. | 322, 358, 398             |
| First use .....           | 318, 354, 394             |
| General information ..    | 317, 350, 390             |
| Malfunctions .....        | 340, 380, 419             |
| Operation .....           | 323, 359, 399             |
| Replacing                 |                           |
| fuses ...                 | 337-339, 377-379, 416-418 |
| Switching off             | 344-345, 385-386, 423     |
| Switching on ...          | 319-320, 355, 395         |
| Winter operation .....    | 334, 373, 412             |

### On-board kitchenette/attendant call

|                       |         |
|-----------------------|---------|
| Enabling switch ..... | 79, 172 |
|-----------------------|---------|

### Open-jaw trailer coupling and ball hitch trailer coupling

|                  |    |
|------------------|----|
| Detachable ..... | 31 |
|------------------|----|

### Operating/malfunction displays

|                              |         |
|------------------------------|---------|
| Doors .....                  | 301-303 |
| Fire extinguishing system .. | 102-103 |

### Overview of lighting types .

|  |         |
|--|---------|
|  | 561-562 |
|--|---------|

## P

### Panorama camera .....

|  |     |
|--|-----|
|  | 166 |
|--|-----|

### Parking brake

|                           |         |
|---------------------------|---------|
| Applying .....            | 49      |
| General information ..... | 77, 159 |
| Releasing .....           | 50      |

### Passenger seat

|                 |     |
|-----------------|-----|
| Adjusting ..... | 195 |
|-----------------|-----|

### Passenger seat service set .

|  |         |
|--|---------|
|  | 198-199 |
|--|---------|

### Passenger-compartment

### lighting .....

|  |         |
|--|---------|
|  | 85, 184 |
|--|---------|

### Pneumatic test ports

|                               |         |
|-------------------------------|---------|
| Axle modulator/door 2 .....   | 496     |
| Behind door 2 .....           | 494-495 |
| Under the driver's area ..... | 492-493 |

### Positioning the jack .....

|  |     |
|--|-----|
|  | 480 |
|--|-----|

### PSH (pneumatic shift aid)

### transmission shift system .....

|  |     |
|--|-----|
|  | 202 |
|--|-----|

## R

### Raising/lowering the bus ...

|  |         |
|--|---------|
|  | 83, 181 |
|--|---------|

### Reading lamps .....

|  |         |
|--|---------|
|  | 85, 183 |
|--|---------|

### Rear foglamp .....

|  |     |
|--|-----|
|  | 111 |
|--|-----|

### Refuelling

|                   |       |
|-------------------|-------|
| AdBlue® .....     | 37-39 |
| Diesel fuel ..... | 32-33 |

### Reversing aid in the exterior

### mirror .....

|  |       |
|--|-------|
|  | 93-94 |
|--|-------|

### Roof hatches .....

|  |         |
|--|---------|
|  | 80, 177 |
|--|---------|

### Emergency exit .....

|  |         |
|--|---------|
|  | 312-313 |
|--|---------|

### Roof-mounted system (heating, ventilation, air-conditioning)

|                             |         |
|-----------------------------|---------|
| Electrical connection ..... | 516-517 |
|-----------------------------|---------|

### Rotary light switch .....

|  |         |
|--|---------|
|  | 80, 109 |
|--|---------|

### Running-in guideline .....

|  |    |
|--|----|
|  | 22 |
|--|----|

## S

### School bus operation .....

|  |         |
|--|---------|
|  | 79, 175 |
|--|---------|

### Seat belt

|                     |     |
|---------------------|-----|
| Driver's seat ..... | 196 |
|---------------------|-----|

|   |             |  |         |   |         |
|---|-------------|--|---------|---|---------|
| Jump seat . . . . .                         | 197         | <b>Submenus</b> . . . . .                                  | 124-142 | <b>Transmission shift system (GO 250-8)</b>   |         |
| Passenger-compartment seating               | 197         |  |         | Selector lever . . . . .  | 206     |
| <b>Seat belt reminder</b> . . . . .         | 99          | <b>T</b>   |         | System description . . . . .  | 204     |
| <b>Seat squab</b>                           |             | <b>Tachograph</b>  |         | <b>Transmission shift system/<br/>continuous brake steering<br/>column switch</b> . . . . . | 77, 114 |
| Fitting . . . . .                           | 196         | Display . . . . .  | 90      | <b>Trip meter</b>   |         |
| Removing . . . . .                          | 196         | DTCO . . . . .   | 88-89   | Resetting . . . . .   | 146     |
| <b>Skibox</b>                               |             | <b>Technical data</b> . . . . .                            | 560     | <b>Tyre pressure monitor</b> . . . .  | 470-471 |
| Additional operating instructions .         | 61          | <b>Toilet</b>  |         | <b>Tyre pressures table</b>   |         |
| fitting . . . . .                           | 59          | Filling the fresh water storage                            |         | 295/80 R 22.5 . . . . .   | 476     |
| swivelling . . . . .                        | 60          | tank . . . . .   | 432     | <b>Tyres</b>  |         |
| <b>Snow chains</b> . . . . .                | 478         | Operation, maintenance . . . . .                           | 429     | Flat tyre . . . . .   | 477     |
| <b>Spare mirror</b> . . . . .               | 93          | Winter operation . . . . .                                 | 435     | Inflating using the tyre  |         |
| <b>Spare wheel</b> . . . . .                | 479         | <b>Tools and emergency equipment</b> .                     | 91      | inflator connection . . . . .   | 490-491 |
| <b>Steering</b>                             |             | <b>Tow bar</b> . . . . .                                   | 93      | Invisible tyre damage . . . . .   | 473     |
| Important information . . . . .             | 165         | <b>Towing</b> . . . . .                                    | 26-28   | Operating safety and roadworthi-<br>ness . . . . .  | 469     |
| <b>Steering column</b>                      |             | <b>Trailer coupling</b>                                    |         | Retreaded tyres . . . . .   | 474     |
| Adjusting . . . . .                         | 109         | Maintenance . . . . .                                      | 32      | Tyre age . . . . .  | 472     |
| <b>Steering column switch</b>               |             | <b>Trailer towing</b> . . . . .                            | 29      | Tyre condition . . . . .  | 472     |
| Light and wiper func-<br>tions . . . . .    | 77, 112-113 | Power supply . . . . .                                     | 32      | Tyre load capacity, top speed of<br>tyres and types of tyres . . . . .                      | 473     |
| <b>Steering wheel buttons</b> . . . .       | 115-117     | <b>Transmission shift system</b>                           |         | Tyre pressure . . . . .   | 470     |
| left . . . . .                              | 77          | Safety precautions . . . . .                               | 202-203 |   |         |
| right . . . . .                             | 77          | <b>Transmission shift system (GO 250-8<br/>PowerShift)</b> |         |   |         |
| <b>Storage space for hand luggage</b> . . . | 9           | Failsafe mode . . . . .                                    | 217-219 |   |         |
|   |             | Operation . . . . .  | 207-216 |   |         |

Tyre tread ..... 472

## U

### Unlocking

Door circuit at the front right  
door ..... 304

Door circuit by key remote .... 305

Luggage compartment flaps using  
the pushbuttons in the driver's  
area ..... 305

**Upper windscreen wiper/  
headlamp cleaning system** .. 79, 172

## V

### Variable speed limiter (TempoSet)

Activating ..... 229-231

**Volume adjustment** ..... 147

Driver's rest area/on-board  
kitchenette intercom ..... 149

Passenger-compartment on-board  
PA system ..... 149

Radio ..... 147-148

Telephone ..... 150

## W

### Wheel trims

fitting ..... 489

removing ..... 481

### Wheels

Fitting ..... 487-488

Removing ..... 482-486

### Windscreen heating/driver- 's window heating+mirror

heating ..... 79, 171

Windscreen roller sunblind .. 79, 171

Windscreen washer reservoir .... 98