

Guide for Rescue Services
SETRA buses and coaches built during or later than 1995

Edition 2008



Contents

Contents	1
1 Publisher's information	4
1.1 Questions and suggestions	4
1.2 Legal notices	5
1.2.1 Copyright	5
1.2.2 Products	5
1.2.3 Trademarks	5
1.2.4 Liability and warranty	5
2 Foreword	6
3 Tips for rescue teams	7
3.1 Medical aspects	7
3.2 Technical aspects	8
3.3 Tactical operational aspects	8
3.3.1 Operational procedure	9
3.3.2 Fire protection	10
3.3.3 Multiple casualty incident	10
4 Technical information	11
4.1 Diesel drive	11
4.1.1 Tank material and capacity	11
4.2 Vehicle body	12
4.2.1 Body frame	12
4.2.2 Materials	13
4.2.3 Articulation joint	14
4.2.4 Dimensions / weight	14
4.3 Materials used	15
4.3.1 Magnesium and aluminium	15
5 Technical Rescue	16
5.1 Fire detection / fire extinguisher system	16
5.2 Battery	17
5.2.1 Disconnecting the battery	18
5.3 Switching off the engine	20
5.3.1 Removing the key	20
5.3.2 Start/Stop switch at driver's station	20
5.3.3 Start/Stop switch in the engine compartment	20
5.3.4 Battery circuit breaker	21
5.3.5 Main isolating switch	21
5.3.6 Covering the air intake	22
5.3.7 Injecting CO ₂	22
5.3.8 Opening the engine compartment flap	23
5.4 Securing and support	24
5.4.1 Support	24
5.4.2 Wheel chocks	24
5.4.3 Supporting struts	24

5.4.4	Endless slings	25
5.4.5	Lifting the vehicle	26
5.4.6	Lifting / lowering system and kneeling	28
5.5	Entering the vehicle	29
5.5.1	Vehicle doors	30
5.5.2	Opening vehicle doors from outside	31
5.5.3	Opening doors from inside	34
5.5.4	Driver door	35
5.5.5	Opening emergency exits (roof hatches)	36
5.5.6	Removing windows	38
5.5.7	Cutting open the bellows	38
5.6	Driver's station	39
5.6.1	Cab door	39
5.6.2	Driver seat adjustment	40
5.6.3	Steering column	41
5.7	Passenger compartment	42
5.7.1	Passenger restraint systems	42
5.7.2	Adjustment of passenger seats	42
5.7.3	Attachment of passenger seats / removal of passenger seats	43
5.7.4	Handrails and partition walls	45
5.7.5	Luggage racks	45
5.8	Special areas	46
5.8.1	Toilet cabin	46
5.8.2	Galley	47
5.8.3	Luggage compartment	47
5.8.4	Driver rest area	48
5.8.5	Ski boxes	49
6	Characteristics	50
6.1	Definition of bus	50
6.2	Classification	50
6.3	Distinguishing characteristics	51
7	Annex	52
7.1	Model plate	52
7.1.1	Vehicle Identification Number (VIN)	54
7.2	Characteristics of City buses	56
7.2.1	S 315 NF,	57
7.2.2	S 319 NF, 2 doors	58
7.2.3	S 415 NF, 2 doors	59
7.2.4	S 415 NF, 3 doors	60
7.2.5	S 416 NF, 2 doors	61
7.3	Characteristics of Interurban buses	62
7.3.1	S 315 H, 2 doors	63
7.3.2	S 313 UL, 2 doors	64
7.3.3	S 315 UL, 2 doors	65
7.3.4	S 319 UL, 2 doors	66
7.3.5	SG 321 UL, 3 doors	67

Contents

SETRA Rescue Guide

7.3.6	S 412 UL, 2 doors	68
7.3.7	S 415 UL, S 416 UL, 2 doors	69
7.3.8	S 417 UL, S419 UL, 2 doors	70
7.4	Characteristics of coaches	71
7.4.1	S 309 HD	72
7.4.2	S 312 HD, S 315 HD	73
7.4.3	S 315 HDH, S 317 HDH	74
7.4.4	S 328 DT	75
7.4.5	S 315 GT	76
7.4.6	S 315 GT-HD	77
7.4.7	S 317 GT-HD	78
7.4.8	S 319 GT-HD	79
7.4.9	S 411 HD	80
7.4.10	S 415 HD	81
7.4.11	S 415 HDH	82
7.4.12	S 416 HDH	83
7.4.13	S 417 HDH	84
7.4.14	S 431 DT	85
Index		86

1 Publisher's information

1.1 Questions and suggestions

If you have any questions, suggestions or proposals on this rescue guide, please feel free to contact us at:

EvoBus GmbH / Setra Buses and Coaches

Kässbohrerstrasse 13
D-89077 Ulm

E-mail: serviceinformation@evobus.com

1.2 Legal notices

1.2.1 Copyright

Copyright 2007 EvoBus GmbH. All rights reserved. The text, images and graphics are all subject to copyright and other intellectual property protection. These objects may not be copied for commercial use or distribution, nor may these objects be modified or used.

1.2.2 Products

The information is subject to change following the editorial deadline. The information in this description is to be regarded as an indication. Errors excepted. Colours may vary for technical reasons. This description may also contain models and consulting services that are not available in some countries.

1.2.3 Trademarks

Unless otherwise indicated, all brands mentioned in this product description are subject to the trademark rights of EvoBus GmbH and/or DaimlerChrysler AG, its model nameplates, and its corporate logos and emblems.

1.2.4 Liability and warranty

EvoBus GmbH provides this information without guarantee or warranty of any kind, express or implicit. This shall also exclude any implied warranties of merchantability, fitness for any particular purpose or non-infringement of laws and patents. While the information provided is believed to be accurate, it may include errors or inaccuracies, for which we shall not assume any liability.

2 Foreword

Dear readers,

One of the traditional goals of the EvoBus GmbH company philosophy and the SETRA Buses and Coaches brand has always been to guarantee the maximum possible safety.

This also includes making available information about our vehicles and their safety technology for rescue teams

Despite intensive efforts to make our buses as safe as possible, the possibility of injury cannot be completely ruled out in the event of an emergency.

A short, fast and effective rescue chain will therefore continue to be unavoidable in the future. The rescue teams must get access as quickly as possible to the injured without increasing the danger for the casualties or themselves.

The prerequisite for this is the sound training of all rescue personnel. In view of the special circumstances for buses, e.g. construction, special access arrangements and safety systems, this guide will assist you in your work both during operations and in the training of rescue teams.

This guide has been written in the light of the latest knowledge and with the help of personnel from the rescue services, but makes no claim to completeness and is in no way a substitute for sound training and the relevant specialist literature on the topic of "Technical Rescue".

The guide is intended to provide support for rescue teams during operations and training. Since every accident, especially with buses, is an exceptional situation, the information in this guide must be adapted to each individual case.

EvoBus GmbH
AST Department

3 Tips for rescue teams

The rescue of persons from cars involved in accidents has in recent times become standard practice for rescue teams. This operation can be practised without any problem using discarded cars.

However, for buses and coaches the situation is different. Owing to the long service life and the high residual value, it is almost impossible for rescue teams to exercise the rescue of injured persons from current vehicle models.

In comparison to motor car accidents, the patient-orientated rescue of persons from buses and coaches is much more costly, and not only because of the high number of injured. The more stable construction together with the significantly greater dimensions and weights of the vehicles make the rescue of trapped persons more difficult and complicated.

3.1 Medical aspects

Whereas up to a few years ago the fastest release of accident victims stood in the foreground, today it is medical initial emergency care and patient-orientated rescue from the vehicle that is of primary concern.

Exception

- Immediate danger due to fire or crash
- Crash rescue necessary on medical grounds

In every case the (hectic) pulling out of persons must be avoided at all costs. The accident victim should initially be left in the vehicle as long as there is no immediate danger for the person and rescuers.



The top priorities are the medical and psychological care of the accident victim, together with a careful, patient-orientated rescue from the vehicle.

The medical action taken in the vehicle should be limited to what is absolutely essential. At the same time access to the accident victim for the emergency doctor or rescue service must be facilitated to allow the life-saving measures to be carried out.

The vital immediate measures must be carried out without delay in accordance with the relevant current medical standard.

Tips for rescue teams

SETRA Rescue Guide

The most important immediate measures are:

- Assure the vital functions (breathing, circulation)
- Keep the airways free, and clear any breathing obstructions (possibly by intubation)
- Prevent shock or assess the state of shock and take stabilisation measures
- Take care of life-threatening injuries
- Stop serious bleeding
- Immobilise certain parts of the body
- Psychological care of the accident victim

In an accident very high accelerations act on the body, so there is a high risk of spinal injury. If necessary, the accident victims must be immobilised before taking any rescue measures; i.e. taken care of, using the appropriate bracing procedures (e.g. "Stifneck", Kendrick Extraction Device (KED) etc.).

During the rescue operations the accident victim must be given constant medical care. It is essential to ensure a careful course of action.

3.2 Technical aspects

- Identification of the vehicle model
- Visual check for installed restraint and safety systems
- Body features in relation to the use of hydraulic rescue equipment

3.3 Tactical operational aspects

During the rescue action there are numerous risks of injury for the patients and rescuers, e.g. due to

- running engines
- explosion of high pressure gas tanks and lines
- electronic equipment and defective electrical wiring
- hot water equipment
- coolant leaks
- air conditioners
- acid leaks
- sharp edges, metal parts, shards of glass etc.



Always pay attention to the personal safety of the rescuers.

3.3.1 Operational procedure

The aim of the patient-orientated rescue is to ensure wherever possible the seamless care of patients from the accident scene until the time of definitive care in hospital.

The rescue of accident victims from buses may be divided into different phases, in the same way as for passenger cars:

1. Initial opening
2. Care opening
3. Release opening

Through the parallel execution of medical and technical measures it is possible to optimise the time for a patient-orientated rescue.

During this time it is essential to have constant communication between the fire service and the rescue team.

An initial assessment and the external securing of the vehicles involved in the accident or of the accident site always come at the start of the operation.

Initial assessment

- Number of vehicles involved
- Number of injured and trapped persons
- Special technical features of the vehicles
- Possibilities for access and release
- Special hazards

Making the outside safe

- Make the accident site safe against flowing traffic
- Ensure fire protection by making ready suitable extinguishing agents
- Secure luggage, ski boxes, trailers etc.
- Illumination of the accident site



Give immediate feedback to your command post.

Ask for additional support in good time; do not forget the support required for medical care, such as the senior emergency doctor, organisational leader, quick response groups etc.

For tactical operational reasons (vehicle height) it is advisable to call up elevating rescue vehicles at an early stage: e.g. turntable ladder with basket and stretcher support.

Note section 3.3.3 Multiple casualty incident

3.3.2 Fire protection

The time between fire outbreak and conflagration is only a few minutes. Therefore it is essential to provide three or fourfold fire protection for classes A, B C, and D.

A fire risk exists during rescue work primarily due to

- escaping service fluids
- short circuit
- defective heaters

3.3.3 Multiple casualty incident

Owing to the possibility of a high number of casualties in bus accidents, in addition to the "Technical Rescue" team, there will usually be a need to set up a "Multiple casualty incident" team.

This requires additional rules regarding the operations logistics chain, the organisation of space, and the operations command system.

The following points must be given special treatment, particularly when the site of operations is confused and constricted:

- coning off the accident scene over a wide area, setting up road blocks
- alternative approach and exit routes for reinforcements
- requesting additional support
- staging areas for fire service, rescue service, disaster containment, police etc.
- preparation areas for fire and rescue service, ambulance service, disaster prevention, police etc.
- casualty holding and treatment areas
- establishing and securing a helicopter landing site

4 Technical information

In the bus industry too development has not stood still. So beside the conventional petrol or diesel engine there are more and more buses with alternative drives coming into use. Gas and fuel cell drives are no longer a rarity.

In addition, with regard to the body and the materials used, there are some special features compared with the construction of a passenger car. For example, we must assume that the dimensions will be significantly greater and the weight higher. Similarly, the articulated vehicle is also something special which rescuers should give thought to in good time.

4.1 Diesel drive

Diesel propulsion is the oldest and the most widespread. This is probably where the fewest questions are raised about ensuring fire protection. Yet even here there are some things to note that are not so relevant for operations involving crashed passenger cars.



Interurban bus – combined heating fuel oil and diesel tank



Coach – diesel tank

4.1.1 Tank material and capacity

Material	<ul style="list-style-type: none">- plastic- steel sheet- aluminium
Capacity	200 litres (city bus) up to 800 litres (coach)



Diesel and heating fuel oil are assigned to **Fire class B** according to the European Standard EN2 for "Inflammable materials of diverse nature".

4.2 Vehicle body

Knowledge of the construction of the vehicle involved in an accident will facilitate the rescue action enormously. On this will depend how effectively the technical options and the available tools are used. This in turn is the basis for a rapid, careful, and successful rescue of trapped persons.

4.2.1 Body frame



The frame construction may place high demands on the performance of the hydraulic rescue equipment!

The body frame is of tubular construction.

- Semi-integral structure with all-round ribs joined together by continuous angle sections at the roof edges and seams.
- Pillars, bows and side members are made of large square steel tube.
- The sidewalls of city buses have a reinforced longitudinal member to provide protection against side impacts and act as a mounting for the seats.



Body frame (low-floor bus shown here)

4.2.2 Materials

Body frame material

- Square steel tube

Floor frame material

Longitudinal and cross members	Large-volume square tubes or folded and pressed parts
Junctions at the cross members (in front of and behind the rear axle)	Cast-steel nodes
Wheel housing area	Galvanised sheet steel or aluminium - 3 mm at front axle - 2 mm at rear axle

Panelling material

- Strip-galvanised sheet steel or aluminium, thickness approx. 1.0 mm
- FRP mouldings
- Aluminium sheet

The panelling is bonded, spot welded or riveted to the body frame.

The sidewalls and the roof are lined throughout with insulating material.



4.2.3 Articulation joint

The front and rear sections of the vehicle are connected by means of an articulated system.

It consists of support units, a self-supporting turntable and a hydraulic unit.

This articulation joint is especially robust due to the design of the cast parts (grey cast iron with spheroidal graphite, GGG).

The folding bellows and power supply routing are located in the articulation area.

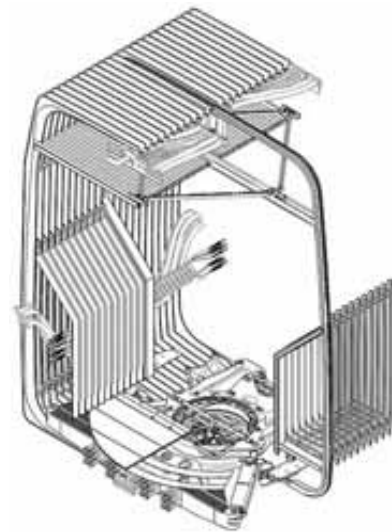

To allow buckling movements of the bus, the front and rear sections of the joint are connected with a roller bearing. The pitch axis is at the junction between the front section of the vehicle and the joint.



Risk of injury!

When lifting articulated buses there is a considerable risk of injury. In particular, with a distorted articulated joint, unforeseen movements can occur.

Proceed with extreme care. Pay attention to the personal safety of the rescuers.

4.2.4 Dimensions / weight

SETRA buses and coaches are built in lengths between 10 m and 18 m (articulated vehicle).

Depending on the length and axle equipment, a permissible gross vehicle weight from 18,000 kg to 28,000 kg is achieved.

4.3 Materials used

Only fire retardant materials are used in the interior of the bus in compliance with the legal requirements (EU and ECE) and the current state-of-the-art.

The requirements of EU Directive 95/28 and 2001/85 EC for the entire vehicle are deemed to have been met.

This especially applies for

- the interior fittings
- the sidewall and roof insulation
- the insulation of the engine compartment
- the insulation of auxiliary equipment etc.

4.3.1 Magnesium and aluminium

In the motor industry, light metals such as magnesium and aluminium are being used more and more. These metal parts find use in the vehicle as engine blocks, cylinder head covers, intake manifolds, transmission or clutch housings, dashboard brackets, seat backrest frames, and door and flap structures in conjunction with other materials and components of vehicle bodies.



Magnesium and aluminium are assigned to **Fire class D** according to the European Standard EN2 for "Inflammable materials of diverse nature".



Risk of injury!

Magnesium and aluminium components burn with a bright flame.

Avoid looking directly into the flames.

Magnesium and aluminium reach temperatures of 2000 - 3000°C in a fire.

Use appropriate extinguishing agents for metal fires.

During combustion at very high temperatures a part of the water molecules are split. When this happens hydrogen and oxygen are released. The mixture of these two gases is the explosive oxyhydrogen gas.

Use appropriate extinguishing agents for fighting fires of Fire Class D.
Have a further hose ready for any fires in the vicinity.



There is no increased danger for bus passengers through the use of magnesium and aluminium.

5 Technical Rescue

Every instance of technical assistance, in particular the release of trapped or injured persons, requires knowledge of the construction of the vehicle involved in the accident.

In this section you will find information about the equipment of various SETRA buses and coaches. However, since there are numerous items of special equipment for every model, the configuration of individual buses may vary widely.



Whenever possible, ask the **driver** about the precise equipment and operation of the vehicle.

5.1 Fire detection / fire extinguisher system

For SETRA buses and coaches a fire detection / fire extinguisher system in the engine compartment is available as special equipment.

Detection lines monitor the temperature in the engine room. If the set value (160 °C) is exceeded, an alarm appears on the driver display with the text: "Fire in engine compartment".

The extinguishing operation is triggered in the same way. Atomised to a fine spray, the extinguishing agent discharges into the engine compartment from the extinguishing nozzles.



Risk of injury!

Under certain circumstances the fire extinguisher system may not be able to completely and permanently extinguish the fire.

Even if the fire appears to be out, ensure fire protection is in place.

The fire detection lines installed in the engine compartment are at a pressure of about 15 bar. The extinguishing agent lines are at a pressure of 200 bar.

Wear the appropriate protective equipment.

- 1 - Detection line
- 2 - Nozzle 1
- 2 - Nozzle 2
- 4 - Nozzle 3
- 5 - Nozzle 4



5.2 Battery

In almost all buses there are two or more batteries. The batteries may be located in front of, above or behind the axles.



The exact position of the batteries in the individual models may be obtained from section 7 - Appendix.

The battery position is not indicated on the outside of the vehicle.

The batteries are mounted on removable trays.

1. Open the locking screws / split pins of the battery supporting frame.
2. Pull out the tray by the carrying handles.
3. If the batteries are arranged one above the other loosen the locking screws/split pins of the upper frame.
4. Swing the upper battery to the right.



Public service bus



Public service / interurban bus



Coach

5.2.1 Disconnecting the battery



Do not disconnect the batteries until you have made use of all electrical loads for your own benefit e.g. window lifter on the driver door, the door openers, roof hatches, driver seat adjustment, interior lighting etc. This can considerably simplify the further course of the operation and the rescue of casualties.



After disconnection of the batteries the interior lighting will no longer function. Avoid panicking passengers by, for example, floodlighting the vehicle.



Risk of injury!

When working on batteries there may be a risk of injury and explosion.

Observe the safety warnings on the battery, in the user instructions and in the vehicle operating manual.

Inside enclosed battery compartments an oxyhydrogen mixture may build up. On disconnecting the battery there may be a risk of explosion.

Always pull the battery tray right out. Wear the appropriate protective equipment.

On some vehicles disconnecting the battery can cause the driver seat to lower.

Carry out this operation only in consultation with the emergency doctor.

Any uncontrolled movement may lead to the risk of further injury or to a worsening in the condition of the casualty.

Instead of disconnecting the battery it is recommended that you use the battery circuit breaker.



Disconnecting the battery

1. Switch off the ignition.
2. Disconnect the negative terminal.
3. Disconnect the positive terminal.
4. Hold the positive and negative cables together to discharge voltages stored across capacitors.
5. Check that circuits are dead by, for example, switching on the hazard warning flasher.
6. Protect the cables against being re-energised or making contact by, for example, using cable ties.



After disconnecting the batteries also make sure that fire protection is in place.

5.3 Switching off the engine

In the case of diesel engines the engine may continue running after an accident. After securing the vehicle it must be switched off.

There are a number of ways to switch the engine off.

5.3.1 Removing the key

The ignition lock is located on the right of the steering column. Before you remove the key, the following criteria must be met:

- accelerator not depressed
- parking brake on
- pushbutton switch "N" of transmission operated

5.3.2 Start/Stop switch at driver's station

Some buses are equipped with a Start/Stop switch.

This is found either

- on the console to the left of the driver's station or
- on the instrument panel.

Left switch: isolated onboard voltage

Right switch: Start/Stop switch



5.3.3 Start/Stop switch in the engine compartment

Besides the ignition lock and the Start/Stop switch near the driver, there **may** also be additional Start (1) and Stop (2) switches in the engine compartment.

To stop the engine with switch (2), the following conditions must be met:

- ignition lock in drive position
- operation of the Stop switch (2)

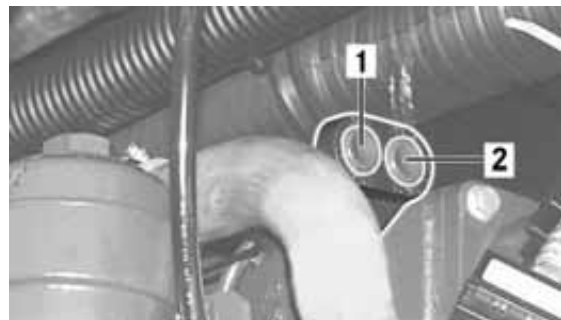

5.3.4 Battery circuit breaker

Operating the battery circuit breaker will interrupt the current supply to the injection system. After 2-3 injection operations the engine will stop.



Note that, after disconnecting the batteries, all electrical loads, such as window lifters, door openers, roof hatches, seat adjustment, interior lighting etc. will cease to work.

5.3.5 Main isolating switch

Some models have a main isolating switch fitted. It is located on the console to the left of the driver and is coloured red.

Operating the main isolating switch will switch off the engine. Speedometer, instrument cluster, central locking, interior lighting and roof hatches will still function.

1. Unlock the switch by turning the red knob to the left.
2. Operate the switch by pressing the red knob.



5.3.6 Covering the air intake

Another way is to cover the air intake with a plastic foil. Due to the reduced oxygen supply, a vacuum builds up and the engine stops.

The engine air intake (1) is located at the rear on the right or left side of the vehicle.

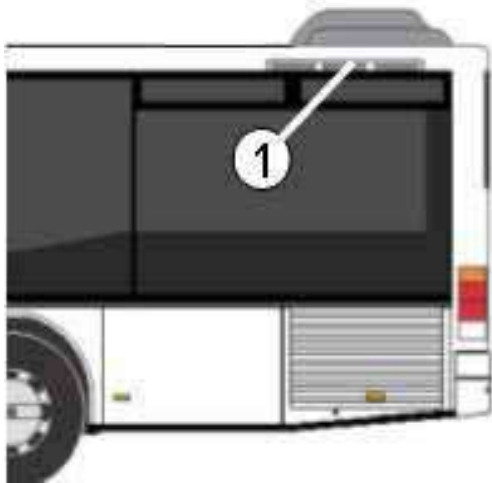

City bus



City bus

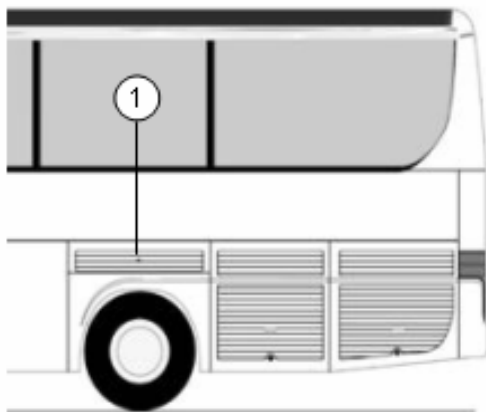

Coach

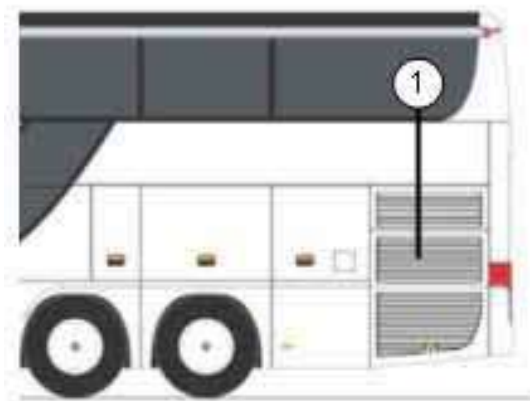

Coach

5.3.7 Injecting CO2

The engine can also be stopped by injecting carbon dioxide (CO₂) into the air filter.

5.3.8 Opening the engine compartment flap

Open the engine compartment flap by the two handle recesses.



In order to switch off the engine, you may, if necessary, interrupt the fuel supply at the fuel filter in the engine compartment.

- Close the hand wheel (1) at the fuel filter or
- Unscrew the fuel filter.



5.4 Securing and support



Risk of injury!

Rescue action can bring about unintentional movement of the vehicle. This can lead to further injury to the accident victims and put the rescuers at risk.

Before beginning rescue work, secure the vehicle against uncontrolled movements.

A patient-orientated rescue of injured persons from the vehicle can only be done after adequate stabilisation of the vehicle.

The bus must be prevented from rolling away by applying the parking brake (hand brake valve) if this has not already been done by the driver.



Persons who are trapped are in direct contact with the vehicle. For this reason it is necessary to make sure that the action of securing the vehicle does not cause uncontrolled movements of the vehicle or parts thereof.

The secureness of the vehicle must be maintained during the entire rescue operation, and must not hinder the use of rescue equipment by the fire service.

The stabilisation of buses that are standing or on their side is relative easy. Here the vehicle can be secured against tipping and sliding with chocks, supporting struts, ropes and belts.

A bus that is unstable or lying on its roof requires extensive supporting materials and even perhaps the use of a mobile crane.

5.4.1 Support

The vehicle can be stabilised using wooden pads, blocks or planks.

5.4.2 Wheel chocks

Wheel chocks can be used to stop the bus rolling away.

5.4.3 Supporting struts

Buses on their side can be secured against tipping and sliding using supporting struts or special support systems.

5.4.4 Endless slings

If the vehicle is on sloping or uneven terrain, such as a road embankment, the vehicle can be secured using an endless sling in conjunction with a mobile crane, depending on the situation.



Because of the heavy weight of a bus it is essential to observe the safe working load of straps.

Suitable slinging points are:

- Coupling jaw at the front located behind the flap in the centre section of the bumper.
- Coupling jaw at the rear located behind a flap in the centre section of the bumper below the number plate.
- Drive axle
- Air suspension bellows

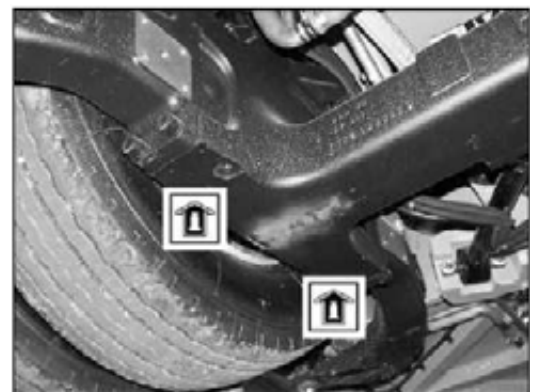
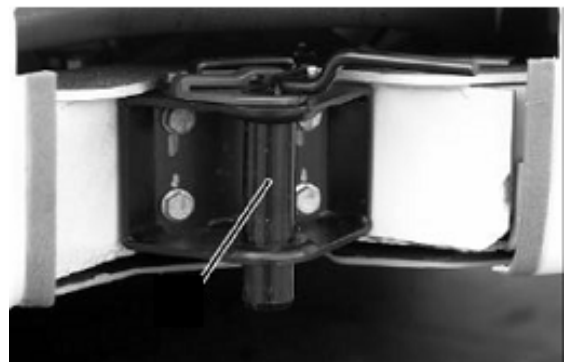

5.4.5 Lifting the vehicle



Risk of injury!

Lifting the vehicle, if not done properly, represents a high risk of injury for patients and rescuers.

Lifting of the entire vehicle must always be done at all the axles.

The vehicle is not stable enough between the axles underneath the side wall (U-section) for it to be lifted or supported there.

Lifting the vehicle can lead to unforeseen movements or even failure of lifting appliances.

Place supports under vehicles being lifted in the course of the operation with materials suitable for the purpose.

Work only on vehicles that are supported or secured.

The lift contact points for the jack on the bodyshell are marked on the outside of the bus by symbols. These points are also suitable as contact points for the lifting appliances of the fire service.



Caution with tandem axles:

Drive axle and trailing axle are interconnected through the suspension design. Lifting a single axle is only allowed so long as the wheels of the second axle do not lift off the ground.

If the vehicle is lying on the roof or on the side, then the reinforced vertical struts by the doors and on the opposite side of the vehicle act as slinging points for straps and endless slings. These points may also be used as contact points for hydraulic or pneumatic lifting appliances: for example to free persons from under an overturned vehicle.

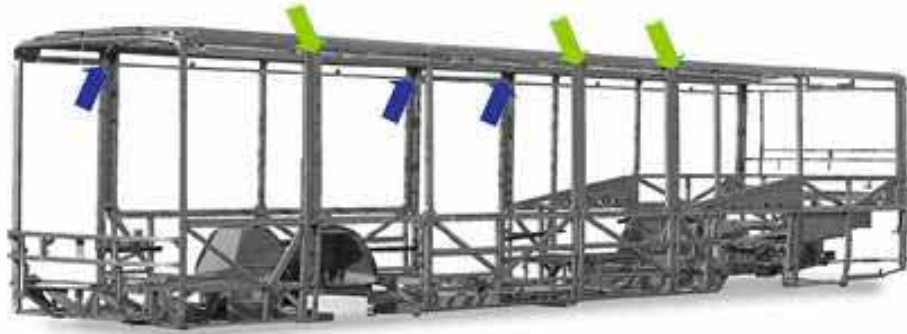

Risk of injury!

When lifting a bus with a mobile crane there is considerable risk of injury.

Always use the lifting points indicated as the slinging points for lifting the bus.
Keep sufficient support material ready.
Do not pull the sling through two opposite windows and lift the bus by the roof. The roofs are not designed for holding a bus.

If a bus is not lifted properly it can flip over onto the other side.

Make sure there is an adequate stabilising / counterbalancing force to prevent the bus flipping over.

If the bus is turned on its roof or the sling runs over the roof, then there will be considerable deformation of the roof, which will reduce the room above the seats.

Carry out this action only with the greatest consideration for the persons inside the vehicle.

5.4.6 Lifting / lowering system and kneeling

Some SETRA buses are equipped with an air-sprung lifting and lowering system.

The rotary knob for the lifting and lowering system is located to the left of the driver seat on the floor of the vehicle.

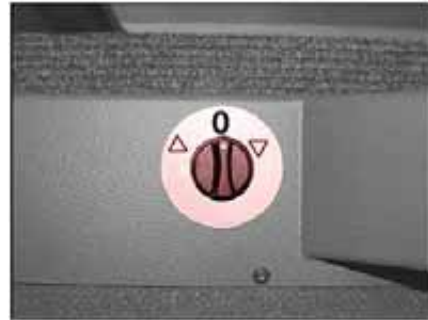

Turn the switch to the right from the central position to lift the vehicle.

Turn the switch to the left to lower the vehicle.

The vehicle will be lifted or lowered by 70 mm respectively.



Using this function it may be possible to free persons trapped under the vehicle.

The lifting function works only when the engine is running and the electrical system is in working order.

If the vehicle is equipped with a "kneeling system", it can be brought up to the normal level by operating the kneeling button.

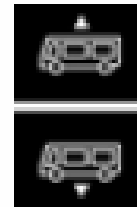

5.5 Entering the vehicle

There are a number of ways to gain entry into the vehicle.

First check if entry is possible via the doors. Whenever possible, the use of rescue equipment should be kept to a minimum.

Other obvious entry options are the removal of the windows, and entry via either the roof hatches or the bellows of the articulated joint (initial opening).

A final option is to use rescue equipment to enlarge an existing opening for the rescue opening. However, this option should only be used as a last resort as there is an incalculable risk due to hidden cables etc.



Because a bus offers the optimum use of space, there are a large variety of equipment variants and uses: e.g. library bus, conference bus, blood donor bus and so on.

Nevertheless, the basic construction of the body frame does not differ essentially from that of a passenger bus.

5.5.1 Vehicle doors

The doors fitted to Setra buses can be classified into three systems:

Inward folding doors



Outward swinging doors



Plug-in sliding door



On export vehicles an emergency door may also be fitted:

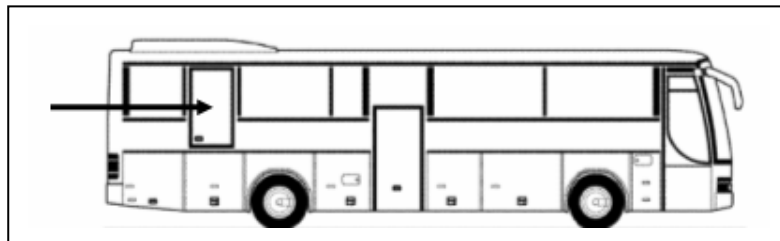

5.5.2 Opening vehicle doors from outside

First try to open the doors normally with the pneumatic or electrical system. If that does not work, use the emergency valves as instructed on the notice next to the door.

Only then should you attempt to open or remove the doors using mechanical aids.



Often the doors can be opened without using technical aids.

Buttons

On city and interurban buses you may be able to open the doors with the "Open door" button on the outside of the door.



Door button outside – city bus

Door opening buttons

On coaches this button is located either

- on the door wing (Door 1), or
- in the front end under the right wiper arm
- .



SETRA Rescue Guide

Outside emergency valve

On buses built during or later than 2005 an emergency valve is fitted on the outside of every door.



Outside emergency valve – example on city bus



Emergency valves on the outside of the vehicle also work after isolation of the vehicle electrical system if they are unlocked from the inside.

Interior emergency valve:

A – Drive position
B – Emergency position

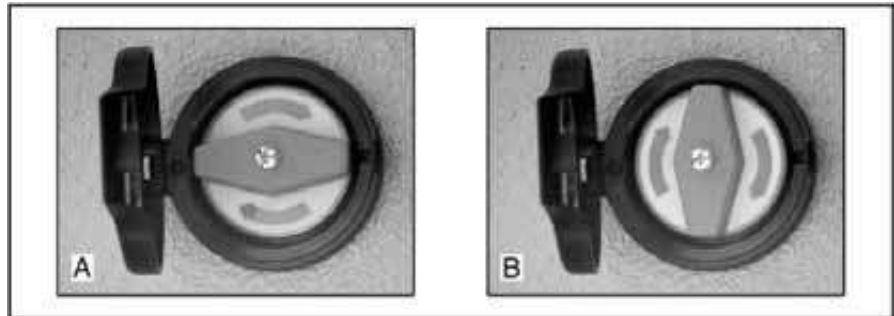

1. If necessary, remove the seal from the emergency valve.
2. Open the emergency valve cover.
3. Turn the emergency valve from the drive position (A) to the emergency position (B).
4. The door system is exhausted and is now depressurised. The door wings can now be opened by hand.

5.5.3 Opening doors from inside

Door buttons

Open the doors by means of the buttons on the instrument panel at the driver's station if you already have entry into the vehicle and electrical power has not yet been isolated.



Buttons at driver's station - city bus



Buttons at driver's station - coach

Interior emergency cock

An emergency valve is fitted on the inside of every door.

Open the doors using a similar procedure as in the section "Opening doors in an emergency".

- 1 – Emergency valve
- 2 – Emergency valve cover



Inside emergency valve – example on city bus



Emergency valves on the inside of the vehicle also work after an electrical power failure.

Square wrench or hand wheel



EU Directive 2001/85/EC requires that it be possible to open doors from the inside (means of escape), even if the door has been closed manually from the outside.

The doors can always be opened from inside using the yellow hand wheel (3).

To open the doors turn the lock (1) with a square wrench (2) or the hand wheel (3) in the direction of the arrow.



Hand wheel – example on city bus



In some cases it may be necessary to remove the doors completely in order to rescue persons. If necessary, also remove the grab rails in the entry area.

Whenever possible do not use a parting grinder or cutting equipment, but hydraulic rescue equipment. Otherwise there is a risk of fire because of the materials fitted in the interior.

5.5.4 Driver door

Some vehicles are fitted with a driver door. This allows direct access to the driver's station. The door is fitted with a lockable handle.



5.5.5 Opening emergency exits (roof hatches)

The roof hatches can be pushed out and are designed as an emergency exit.

They can be opened manually from inside and outside.

The clear escape exit size is 505 x 807 mm (the law requires 500 x 700 mm).

Opening from outside

1. Pull on the red handle.
The roof hatch will then open.

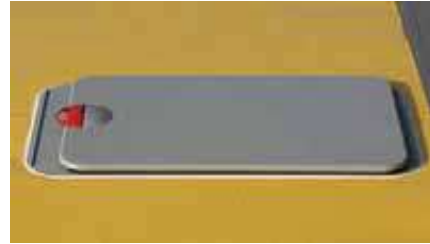

On older buses the roof hatch can only be opened when the ignition is switched on from the outside

Opening from inside

1. Pull the safety lock downward.
This unlocks the roof hatch which can then be opened



1. Remove the cover (1) by pulling on the handle (2) (Velcro strip).



Technical Rescue

SETRA Rescue Guide

2. Turn the inside handle (1) in the direction of the arrow (anti-clockwise).
The cover (2) of the emergency exit can be pushed outwards.
The cover is secured by a check strap.



5.5.6 Removing windows

In general, the windscreen is made of laminated safety glass, and the door, side and rear windows of single-pane safety glass. The window glass is bonded onto the frames.

Laminated safety glass



Risk of injury!

The weight of the windscreen of laminated safety glass can be as much as 120 kg!
This means an increased risk of injury when removing a window glass.

During removal, ensure the windscreen cannot drop down, for example by splitting it into "manageable" pieces.

Single-pane safety glass

1. Mask the windows of single-pane safety glass with foil.
2. Destroy the window glass with the spring punch.
3. Remove the window glass from the frame.



Risk of injury!

The waist rail height, especially on coaches, may be as much as 2 m above the ground.

Ensure there is sufficient staging for the rescue of casualties.

5.5.7 Cutting open the bellows

In the case of articulated buses access to the vehicle may be gained by cutting into the bellows.



5.6 Driver's station

Driver's stations in buses and coaches are complex separate areas, which require a precise knowledge and the application of special rescue techniques.

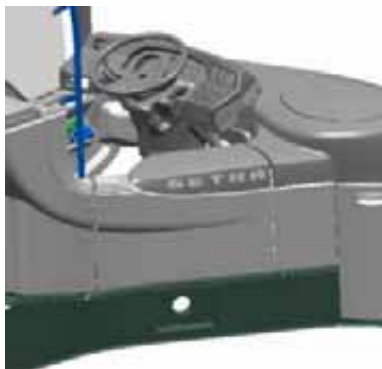

Figure 1: Driver's station – city bus



Figure 2: Driver's station - coach



Risk of injury!

Adjusting the seat or steering wheel, or removing the steering wheel can cause a decompression syndrome of the trapped person.

The release should only be done in consultation with the emergency doctor.

When adjusting the seat or steering wheel make sure that no further danger to the trapped person or the rescuers can occur due to moving parts.



In SETRA buses and coaches there are no airbags or belt tensioners installed.

5.6.1 Cab door

The driver cab door is normally hinged at the front. It is equipped with an inside handle for opening the door.

Material:

- steel frame
- FRP
- trim components made from foam-backed plastic film



5.6.2 Driver seat adjustment

On SETRA buses a wide variety of different driver seats is offered. The operation of the seat adjustment may vary depending on the seat manufacturer.

Air-sprung swivel seats are installed as standard.

Some models have the following equipment, which must be taken into consideration or can be made use of when rescuing a trapped driver:

- Longitudinal adjustment
- Integrated pneumatic system with lumbar support
- Pneumatic side contour adjustment
- Recliner adjustment
- Cushion depth adjustment
- Tilt adjustment
- Horizontal adjustment
- Swivel seat



The handle for the fore-and-aft adjustment of the seat works without power and has the same location for all seat manufacturers.

- Pull the handle upwards and slide the seat.

The other seat adjustment options mostly work only if the power supply is intact.



Cut open the seat bellows and wedge the seat to protect the patient from unintentional movements of the seat.

To reduce the seat height you can cut through the air line.

5.6.3 Steering column

The steering column is installed with a means for

- height adjustment and
- tilt adjustment

The adjustment of the steering wheel can be pneumatically disengaged by means of a switch (1) on the steering column,

or a switch (2) on the instrument panel to the left of the driver.



Figure 3: Steering column lock - coach



Figure 4: Steering column lock - city bus



To release the steering column lock the ignition must be switched ON.



If the driver is trapped behind the steering wheel, it is often sufficient to remove the lower third of the steering wheel.

The procedure for cutting through the steering wheel is the same as for a passenger car.

5.7 Passenger compartment

After an accident it is likely there will be many different problems in the passenger area to deal with. For instance there are different methods of attachment and construction of passenger seats, numerous adjustment options, and restraint systems in some places.

Due to the fitting of handrails, partition walls and luggage racks, after an accident there may be some obstructions, which will make the rescue work more difficult.

5.7.1 Passenger restraint systems

City bus	Interurban bus	Coach
No restraint systems for passenger seats	Restraint system possible, but not mandatory	2-point belts on all seats required by law

5.7.2 Adjustment of passenger seats

City bus	Interurban bus	Coach
No adjustment of passenger seats possible	Seat and backrest adjustment possible	Seat and backrest adjustment possible
No armrests	Armrests adjustable	Armrests adjustable

Side adjustment of aisle seat

Pull the lever (1) upwards while at the same time sliding the seat in the direction of the aisle or into the initial position.



Armrest

Centre armrests and aisle-side armrests fold upwards.

Armrest on aisle side: To fold down the armrest pull it to the rear (against the direction of travel).



Backrest adjustment (aisle-side)

Pull the lever (1) upwards whilst at the same time pressing the backrest to the rear.

Let go of the lever (1) in the desired position.



Backrest adjustment (wall-side)

Pull the lever between the seat surface and the vehicle wall to the rear. At the same time press the backrest to the rear.

Let go of the lever (1) in the desired position.



5.7.3 Attachment of passenger seats / removal of passenger seats

As buses generally have a relative small aisle, which restricts the rescue action enormously, it may be necessary to remove passenger seats.

In SETRA buses and coaches three different seat attachment systems are used.

Here one can roughly differentiate these by the type of service:

- City bus
- Interurban bus
- Coach

There may also be mixed forms, e.g. a city bus may have an attachment system from the interurban bus.

SETRA Rescue Guide

City bus

Seat material: fiberglass-reinforced thermoplast, plywood

Attachment material: steel tube

Cantilever seating with attachment by means of sliding pieces in the C-rail and clamp rail.

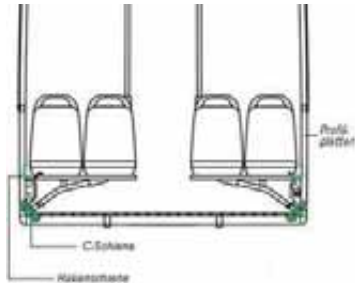

Interurban bus, coach

Seat and backrest frame material: steel tube

Attachment to C-rails, wall-side and platform-side

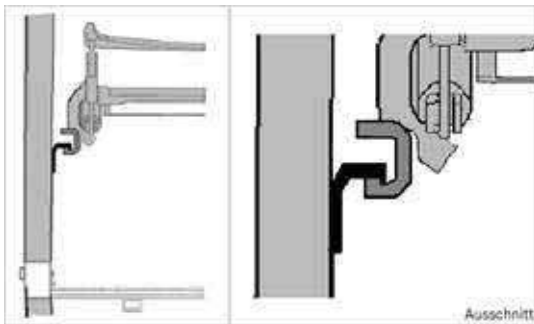

5.7.4 Handrails and partition walls

Handrails

Material: coated steel tube.

Attachment in a C-rail at the ceiling and at the seat backrests or floor.

Partitions

City bus:

The partitions may be made of single-layer safety glass. The panes are clamped in a steel tube frame with rubber pieces.



Coach:

The partitions are made of plastic. Attachment by means of screws in the wall and floor.



5.7.5 Luggage racks

The luggage racks are made of aluminium extrusions, and the floor of the rack is of plastic or perforated aluminium sheet.



Figure 5: Example for an interurban bus



Risk of injury!

Luggage items in the luggage racks present an injury risk after an accident.

Secure the luggage so it cannot fall down, or clear the luggage before beginning with the rescue work.

5.8 Special areas

In particular on coaches there are special areas in which more casualties may be confined, or which can make the rescue work dangerous.

5.8.1 Toilet cabin

On most vehicles the toilet cabin is located in front of the entry to Door 2.



It is rare to find the toilet cabin in the rear of the vehicle.



Risk of injury!

Some toilet systems work with chemical agents.

Keep an adsorbent available to soak up any leaking chemicals.

Observe the usual safety precautions when dealing with chemicals.

5.8.2 Galley

Like the toilet, the galley is located in the area of Door 2 or in the rear.



Figure 6: Galley with coffee machine, hotplate and water heater



Risk of injury!

In the galley there are electric heaters and coolers.

Beware of short circuits or overheating of equipment.

Beware of boiling water.

5.8.3 Luggage compartment

The luggage compartment flaps at the sides may be secured with different systems

- square locks
- cylinder locks
- central locking

The central locking control is located on the instrument panel at the driver's station. It can only be operated when the ignition is switched on.

Operation via the remote control is possible without the ignition being switched on.



 Should none of the above unlocking devices operate, open the luggage flaps with a hydraulic spreader.

Check the luggage compartments for possible sources of fire. In the event of fire in the luggage compartment, remove all items of luggage to prevent the fire from spreading to the passenger compartment.

 Remove the luggage and place it in safe custody at a collection point (task of the police).

 **Risk of injury!**

Jammed luggage compartment flaps may open during the rescue action.

Maintain an adequate safe distance.

5.8.4 Driver rest area

The driver rest area may be located behind the entry of Door 1 or Door 2.

Access:

- from the outside via flaps on the right and left
- from the inside via roller shutters in the door entries

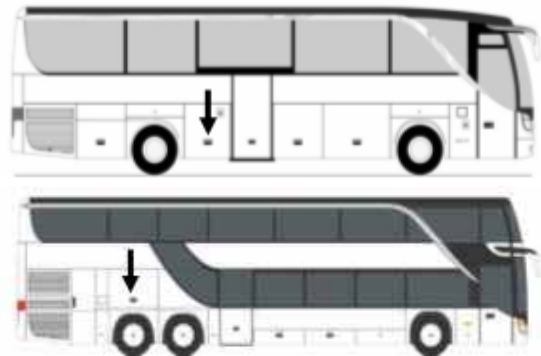

The driver area is marked on the outside and at the access inside the vehicle with a pictogram.



 Carry out a thorough check of all special areas and open all flaps. On some individual special models the special areas may be in positions different from the standard equipment.

5.8.5 Ski boxes

At the rear of coaches there may be ski boxes attached. These boxes may partly cover the rear window and will make access to the vehicle more difficult.



Risk of injury!

The high weight of a loaded box (up to 650 kg) can hamper the rescue action.

Unload the ski box before you lift the bus, and place the contents in safe custody.

6 Characteristics

Every bus model possesses special characteristics that place different demands on the rescue teams.

6.1 Definition of bus

A vehicle intended for the transport of persons having more than 8 passenger seats (without the driver) is designated in German law as a motor bus.

6.2 Classification

Buses may be roughly classified according to their type of service into

- city buses
- interurban buses
- coaches

City bus	Interurban bus	Coach
Urban fixed route services	Inter-city / fixed route services outside the cities	Touring
Vehicles with standing spaces that transport passengers on routes with numerous stops.	Vehicles for transporting seated passengers. Standing passengers in the aisle.	Vehicles for transporting seated passengers.

6.3 Distinguishing characteristics

	City bus	Interurban bus	Coach
Entries (doors)	2 - 4 off double wing width approx. 1.25 m	2 - 4 off single or double wing width approx. 0.70 m - 1.25 m	2 off single-wing width approx. 0.70 - 0.90 m
Step height	low, no steps	with steps	high, with several steps
Waistline height (height above road)	low approx. 1.30 m	low to medium high approx. 1.30 - approx. 1.90 m	low to high approx. 1.30 - 2.20 m
Luggage compartments	none	partial, in floor assembly	in floor assembly
Seats	not adjustable	partially adjustable	adjustable
Backrest	low	high	high
Length	12.00 - 18.00 m	12.00 - 18.00 m	9.00 - 15.00 m
Width	2.50 - 2.55 m	2.50 - 2.55 m	2.55 m
Height	approx. 3.20 m	approx. 3.40 m	approx. 3.60 - approx. 4.00 m
Tank capacity	approx. 210 - 400 l	approx. 300 - 400 l	Up to 630 l
Transport capacity	< 170 persons	< 130 persons	< 80 persons
Axles	2 – 3	2 – 3	2 – 3
Type	solo and articulated buses	solo and articulated buses	solo buses
Weight	up to 28 t	up to 28 t	up to 26 t
Models	S 315 NF S 317 NF S 319 NF S 415 NF S 416 NF	S 315 UL S 319 UL S 315 H S 412 UL S 415 UL S 416 UL S 419 UL	S 315 GT S 315 GT-HD S 317 GT-HD S 309 - 315 HD S 315 HDH S 317 HDH S 328 DT S 415 GT S 415 - 417 GT-HD S 415 HD S 415 – 417 HDH S 431 DT

7 Annex

This section gives an overview of the various models.



This rescue guide is primarily concerned with vehicles subject to the Euro 3 standard. At present these are the vehicles in most widespread use.



The model number can be read from the model plate in the vehicle.

The annex is primarily intended to assist you in training and preparation for rescue operations that may occur. This overview will help you to gain a better appreciation of the bus types in service in your operations area. At least you will then be well prepared for any rescue operations with these buses.

7.1 Model plate

The model plate gives the data for the exact identification of a bus.

The model plate is located in the front entry on the right.



Figure 7: Model plate – here S 415 HD

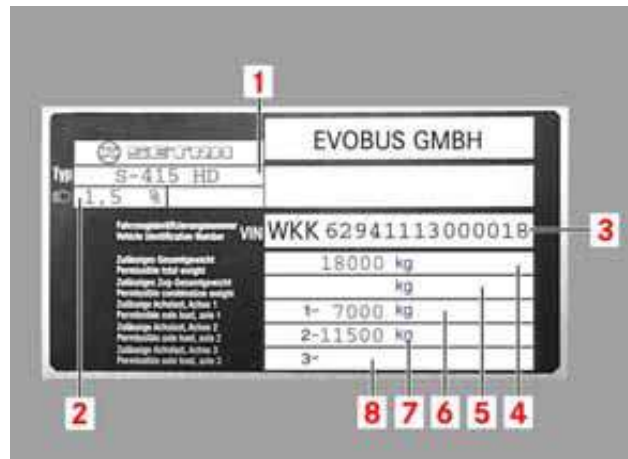

- 1 Fahrzeugbezeichnung
- 2 Scheinwerfer-Grundeinstellung
- 3 Fahrzeug-Identifizierungsnummer (vehicle identification number VIN)
- 4 Zulässiges Gesamtgewicht
- 5 Zulässiges Zug-Gesamtgewicht
- 6 Zulässige Achslast Vorderachse
- 7 Zulässige Achslast Antriebsachse
- 8 Zulässige Achslast Nachlaufachse

Important for identification are items 1 (vehicle model) and 3 (Vehicle Identification Number).

The Vehicle Identification Number (VIN) is also affixed behind the front flap.

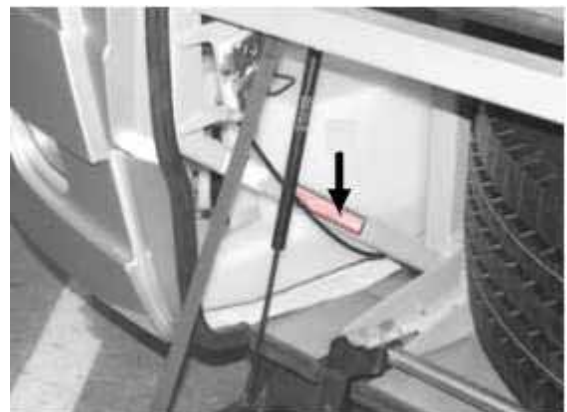

7.1.1 Vehicle Identification Number (VIN)

WKK 629 411 13105068

a)
b)
c)
d)

- a) Manufacturer
- b) Model
- c) Variant
- d) Vehicle Identification End Number

a) Manufacturer

WKK	SETRA
-----	-------

b) Model designation

309	Coach S 309 HD
315	Coach S 315 HD
410	TopClass model series 400 S 431 DT
627	MultiClass model series 300
628	MultiClass model series 400 low-floor
629	TopClass model series 400
632	ComfortClass model series 400
633	MultiClass model series 400

c) Variant

The three digit variant number defines the model more precisely.
 e.g. vehicle length, right/left-hand drive, number of doors

d) Vehicle Identification End Number

The end number enables the precise identification of the vehicle.

SETRA Rescue Guide

Overview of variants

Model	Vehicle model	Name	Variant	L	No. Doors	Comments
	S 309 HD	TopClass HD	Coach		3	High decker coach
	S 315 HD	TopClass HD	Coach	12 m	3	High decker coach
	S 315/ 317HDH	TopClass HDH	Coach	12/13.8 m	3	Super high decker coach
	S 328 DT	TopClass DT	Coach	12 m	3	Double decker coach
410.001	S 431 DT	TopClass DT	Coach	13.89 m	3	Double decker coach
629.410	S 411 HD	TopClass HD	Coach	10.1 m	3	High decker coach
629.411	S 415 HD	TopClass HD	Coach	12 m	3	High decker coach
629.421	S 415 HDH	TopClass HDH	Coach	12 m	3	Super high decker coach
629.425	S 416 HDH	TopClass HDH	Coach	12.99 m	3	Super high decker coach
629.422	S 417 HDH	TopClass HDH	Coach	13.85 m	3	Super high decker coach
627.141	S 313 UL	MultiClass	Interurban bus	11.32 m	2	
627.101	S 315 UL	MultiClass	Interurban bus	12 m	2	
627.281	S 316 UL	MultiClass	Interurban bus	12.8 m	2	
627.151	S317 UL	MultiClass	Interurban bus	13.85 m	2	
627.121	S317 UL	MultiClass	Interurban bus	14.95 m	2	
627.501	SG 321 UL	MultiClass	Interurban bus	18 m	3	Articulated bus
627.201	S 315 H	MultiClass	Interurban bus	12 m	2	
633.100	S 412 UL	MultiClass	Interurban bus	10.8 m	2	
633.101	S 415 UL	MultiClass	Interurban bus	12.2 m	2	
633.102	S 416 UL	MultiClass	Interurban bus	13.04 m	2	
633.103	S 417 UL	MultiClass	Interurban bus	14.05 m	2	
633.104	S 419 UL	MultiClass	Interurban bus	14.98 m	2	
627.401	S 315 NF	MultiClass	City bus	12 m	2	
627.111	S 319 NF	MultiClass	City bus	14.47 m	3	
628.700	S415 NF	MultiClass	City bus	12 m	2	
628.800	S416 NF	MultiClass	City bus	13 m	2	
627.221	S 315 GT	ComfortClass	Coach	12 m	2	
627.251	S 315 GT-HD	ComfortClass	Coach	12 m	2	
627.271	S 317 GT-HD	ComfortClass	Coach	13.85 m	2	
627.261	S 319 GT-HD	ComfortClass	Coach	14.95 m	2	
632.121	S 415 GT	ComfortClass	Coach	12.2 m	2	
632.131	S 415 GT-HD	ComfortClass	Coach	12.2 m1	2	
632.134	S 416 GT-HD	ComfortClass	Coach	13.02 m	2	
632.133	S 417 GT-HD	ComfortClass	Coach	14.05 m	2	
632.138	S 419 GT-HD	ComfortClass	Coach	14.98 m	2	

7.2 Characteristics of City buses

General / Technology

Drive type: Diesel

Number of passengers: up to 170 persons

Mostly standees

Exterior view

Several wide entries

Low entry height

Low waist rail height

Doors

Inward folding and outward swinging doors

Double wing

Pneumatically powered

Width: 1.25 m

Interior equipment and seats

Low backrests

No seat adjustment

No passenger restraint systems

Numerous handrails

"Standing area" for wheelchair passengers, pushchairs

Models

S 315 NF, S 319 NF

S 415 NF, S 416 NF

7.2.1 S 315 NF,

	Model	Length	Doors	Axles	Drive
S 315 NF	627.401	12 m	2	2	Diesel engine

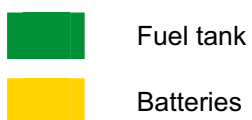
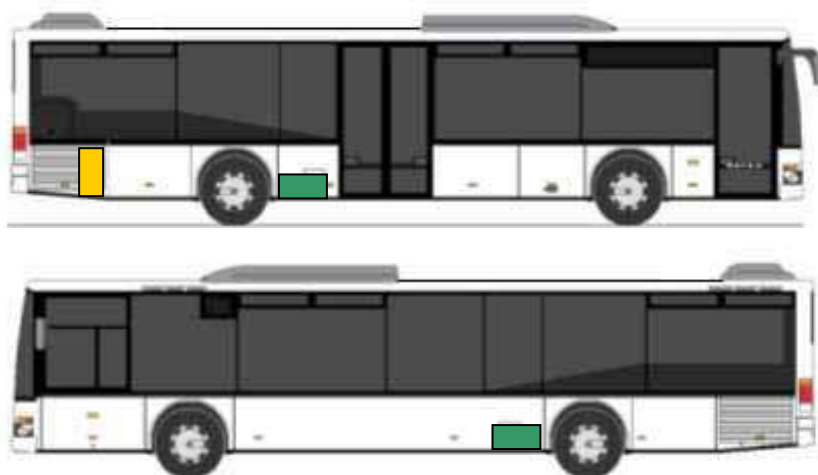

7.2.2 S 319 NF, 2 doors

	Model	Length	Doors	Axles	Drive
S 319 NF	627.111	14.47 m	2	3	Diesel engine



- Fuel tank
- Batteries

7.2.3 S 415 NF, 2 doors

	Model	Length	Doors	Axles	Drive
S 415 NF	628.700	12 m	2	2	Diesel engine

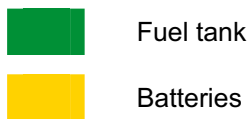
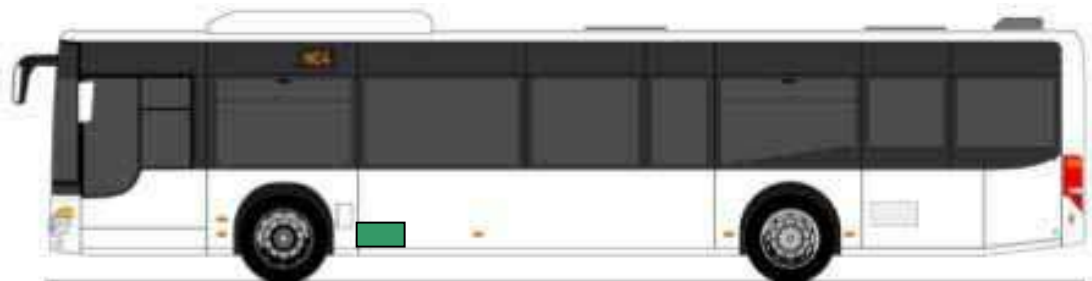
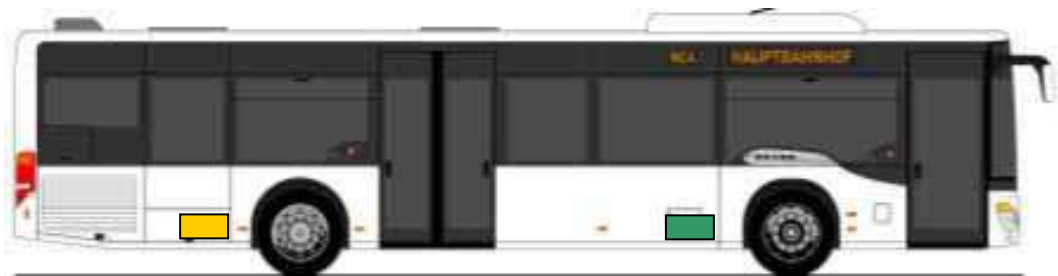

7.2.4 S 415 NF, 3 doors

	Model	Length	Doors	Axles	Drive
S 415 NF	628.700	12 m	3	2	Diesel engine

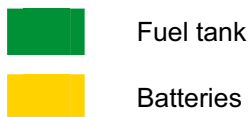

7.2.5 S 416 NF, 2 doors

	Model	Length	Doors	Axles	Drive
S 416 NF	628.8003	13 m	2	2	Diesel engine

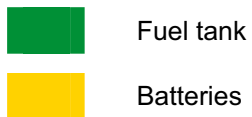

7.3 Characteristics of Interurban buses

General / Technology

Drive: Diesel

Number of passengers: up to 130 persons

Mostly seated

Exterior view

Several entries

Entries with steps

Low to medium height waist rail

Doors

Outward swinging doors

Double wing and single wing possible

Pneumatically powered

Width: approx. 0.70 m - 1.25 m

Interior equipment and seats

Low and high backrests

Seat adjustment possible

Passenger restraint systems possible

Handrails possible

Luggage compartments possible

"Standing area" for wheelchair passengers, pushchairs

Models

S 315 H

S 313 - 319 UL, SG 321 UL

7.3.1 S 315 H, 2 doors

	Model	Length	Doors	Axles	Drive
S 315 H	627.201	12 m	2	2	Diesel engine

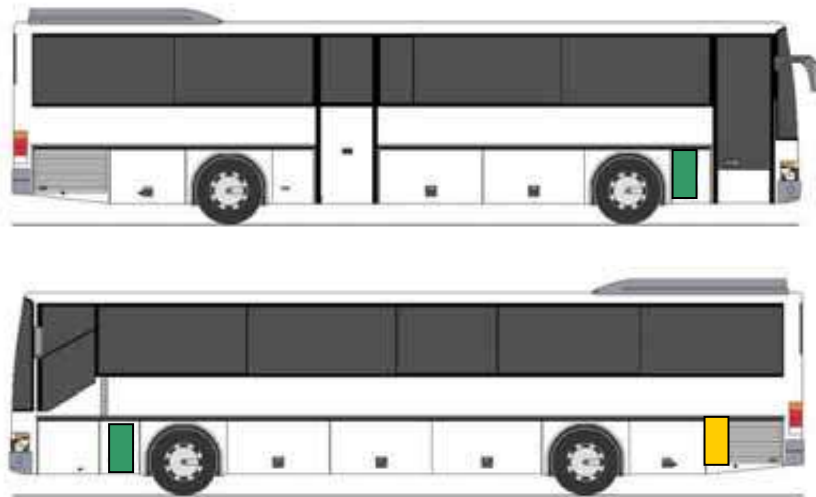

- Fuel tank
- Batteries

7.3.2 S 313 UL, 2 doors

	Model	Length	Doors	Axles	Drive
S 313 UL	627.141	11.32 m	2	2	Diesel engine

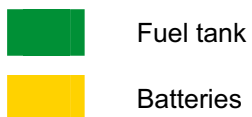
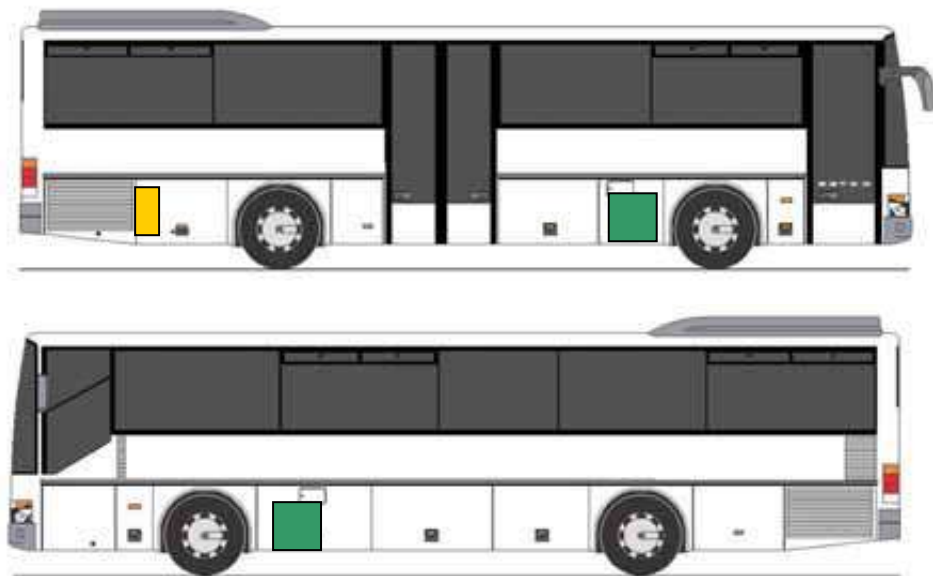

7.3.3 S 315 UL, 2 doors

	Model	Length	Doors	Axles	Drive
S 315 UL	627.101	12 m	2	2	Diesel engine

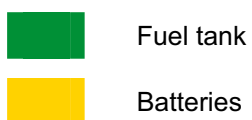
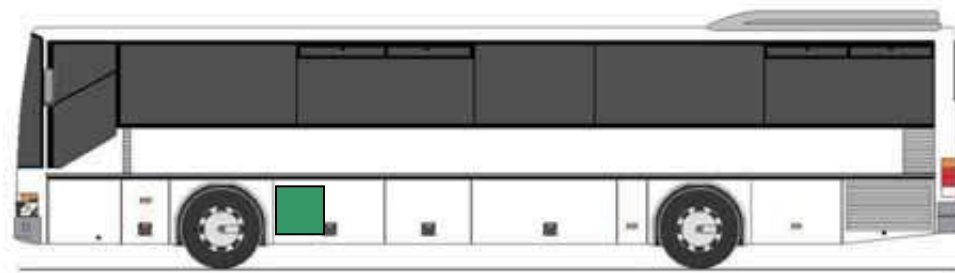
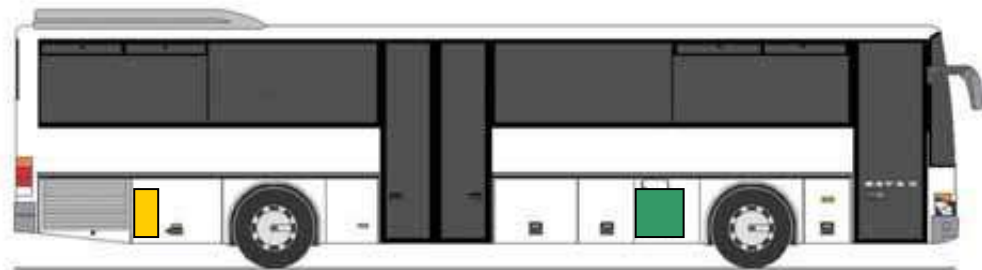

7.3.4 S 319 UL, 2 doors

	Model	Length	Doors	Axles	Drive
S 319 UL	627.121	14.95 m	2	3	Diesel engine

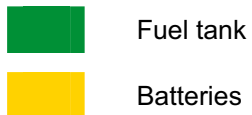
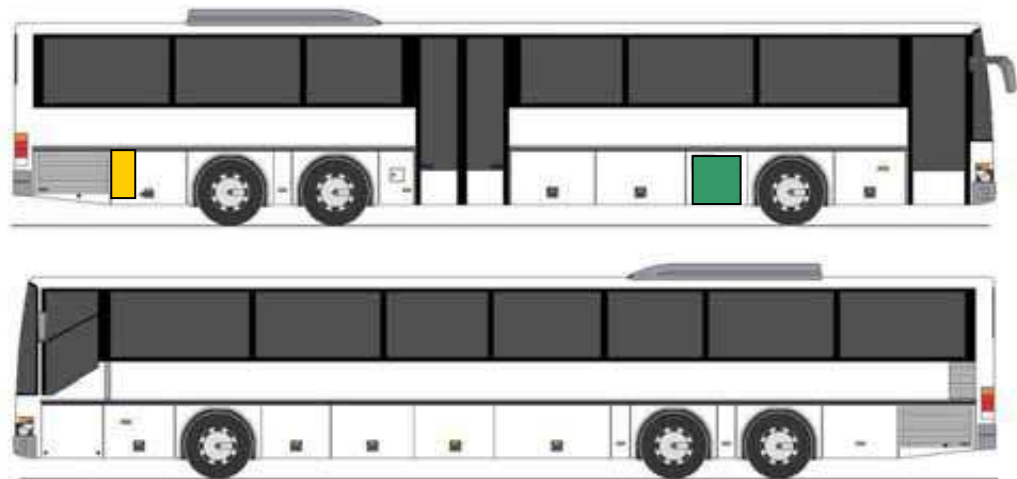

7.3.5 SG 321 UL, 3 doors

	Model	Length	Doors	Axles	Drive
SG 321 UL	627.501	18 m	3	3	Diesel engine

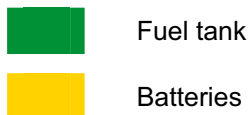

7.3.6 S 412 UL, 2 doors

	Model	Length	Doors	Axles	Drive
S 412 UL	623.100	10.8 m	2	2	Diesel engine

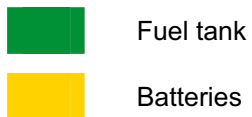
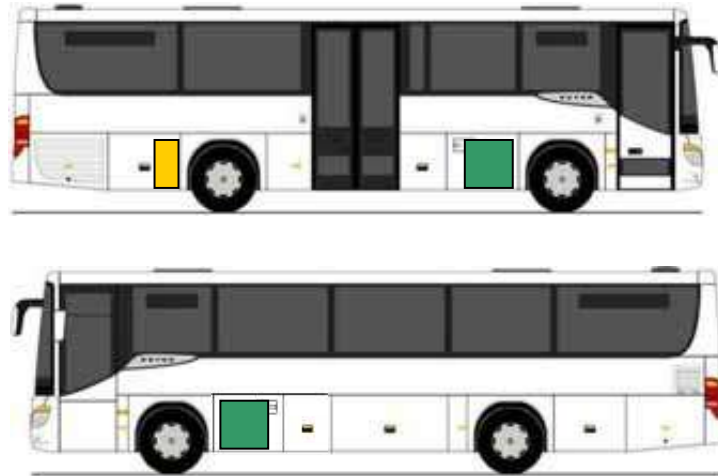

7.3.7 S 415 UL, S 416 UL, 2 doors

	Model	Length	Doors	Axles	Drive
S 415 UL	633.101	12.2 m	2	2	Diesel engine
S 416 UL	633.102	13 m	2	2	Diesel engine



Fuel tank



Batteries

7.3.8 S 417 UL, S419 UL, 2 doors

	Model	Length	Doors	Axles	Drive
S 417 UL	633.103	14.05 m	2	3	Diesel engine
S 419 UL	633.103	14.98 m	2	3	Diesel engine

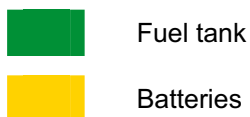
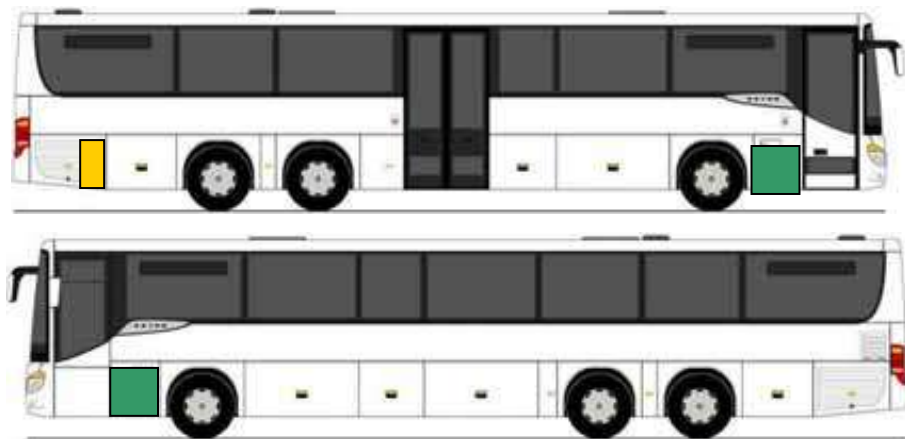

7.4 Characteristics of coaches

General / Technology

Drive: Diesel

Number of passengers: up to 80 persons

Seats only

Exterior view

2 entries

Entries with several steps, height of floor approx. 1.35 m (above road)

High waist rail height approx. 2.20 m (above road)

Doors

Outward swinging doors

Single-wing

Pneumatically powered

Width: 0.70 m (clear width)

Interior equipment and seats

High backrests

Seat adjustment at the side

Backrest adjustment

Passenger restraint system mandatory

Luggage compartments with grab rail

May be toilet, galley, driver rest area, etc.

Models

S 309 HD, S 312 HD, S 315 HD, S 315 HDH, S 317 HDH, S 328 DT

S 315 GT-HD, S 417 GT-HD

S 411 HD, S 515 HD, S 415 HDH, S 416 HDH, S 417 HDH, S 431 DT

7.4.1 S 309 HD

	Model	Length	Doors	Axles	Drive
S 309 HD	626.311	8.87 m	2	2	Diesel engine

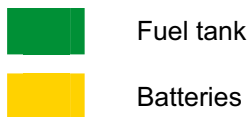
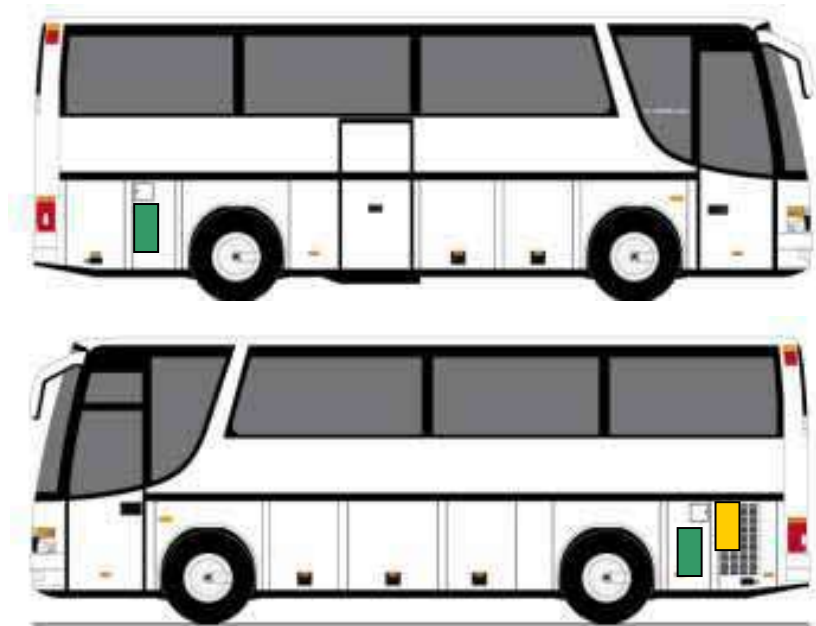

7.4.2 S 312 HD, S 315 HD

	Model	Length	Doors	Axles	Drive
S 312 HD	626.341	10.84 m	3	2	Diesel engine
S 315 HD	626.371	12 m	3	2	Diesel engine

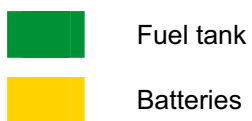
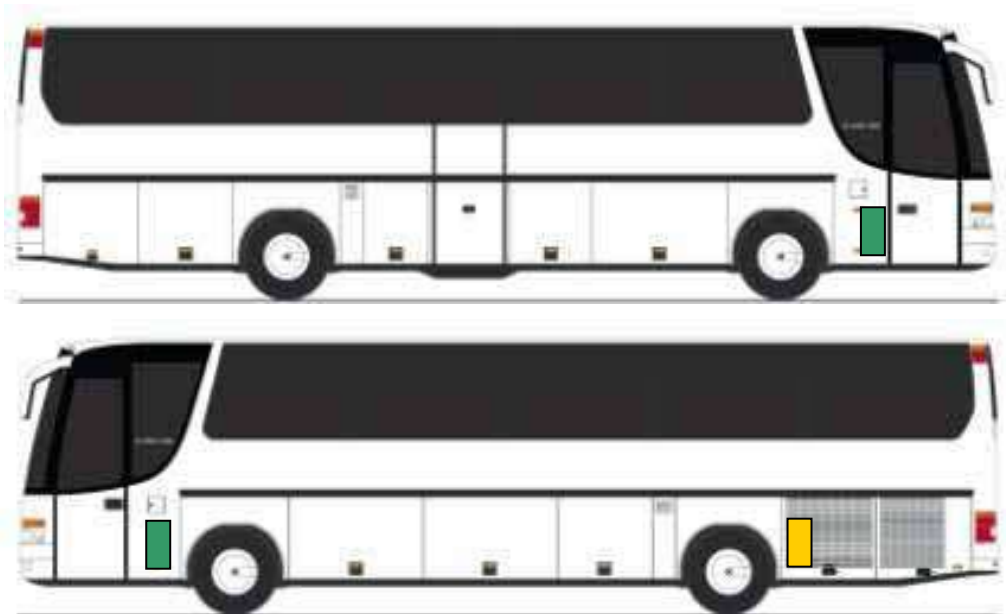

7.4.3 S 315 HDH, S 317 HDH

	Model	Length	Doors	Axles	Drive
S 315 HDH	626.372	12 m	3	3	Diesel engine
S 317 HDH	626.385	13.65 m	3	3	Diesel engine

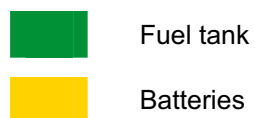

7.4.4 S 328 DT

	Model	Length	Doors	Axles	Drive
S 328 DT	626.390	12 m	3	3	Diesel engine

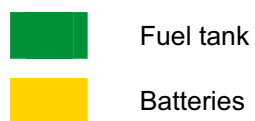
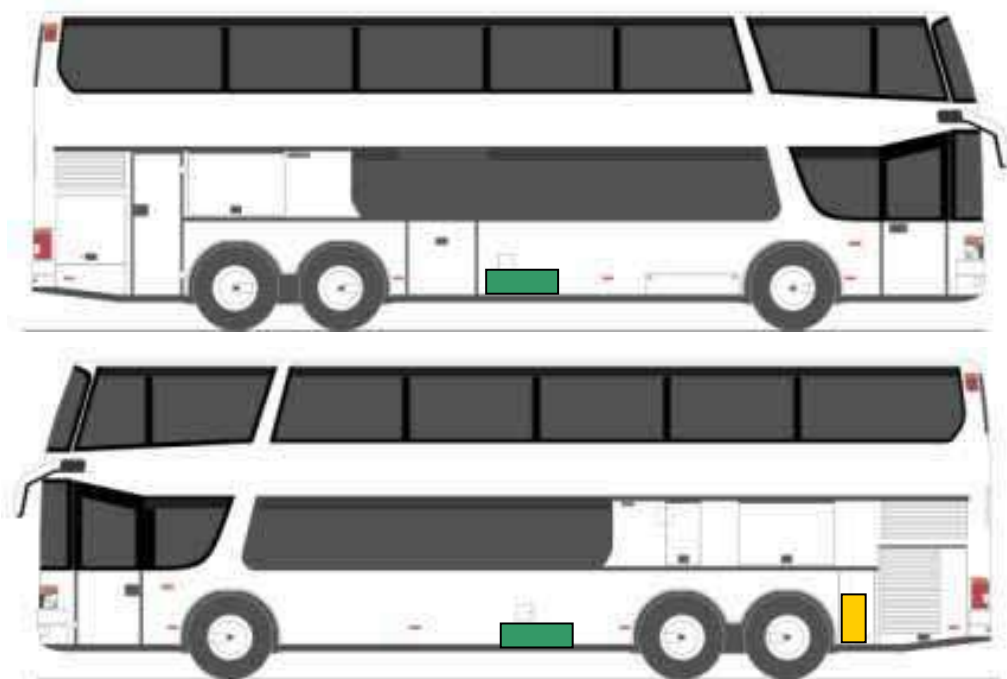

7.4.5 S 315 GT

	Model	Length	Doors	Axles	Drive
S 315 GT	627.221	12 m	2	2	Diesel engine

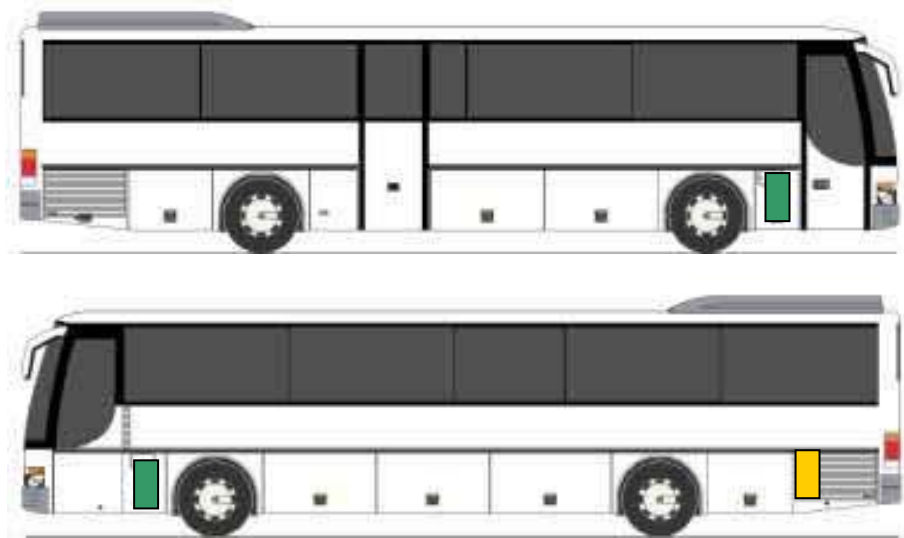

- Fuel tank
- Batteries

7.4.6 S 315 GT-HD

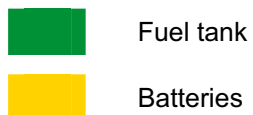
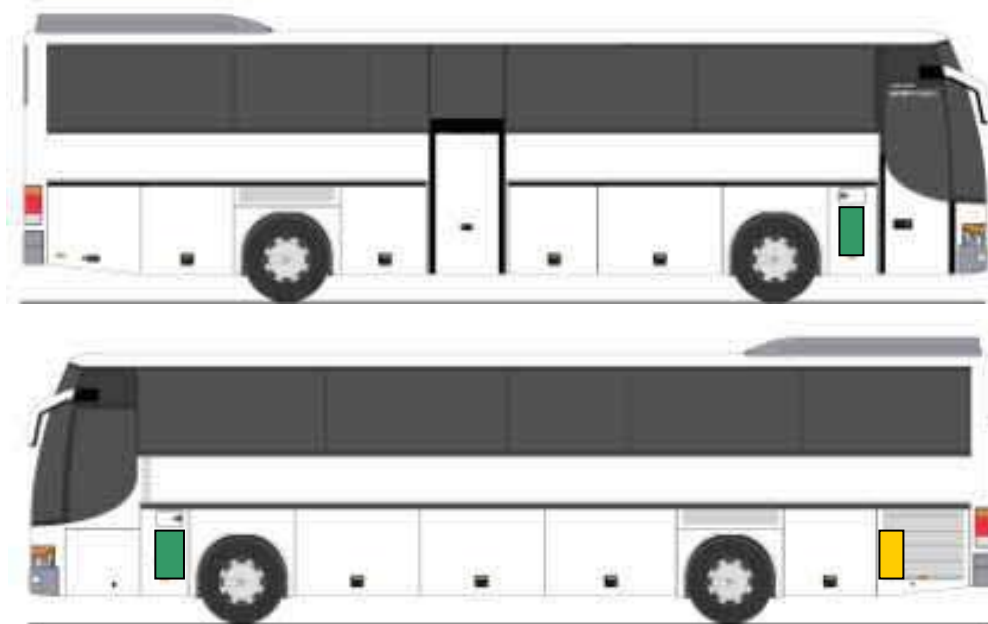

	Model	Length	Doors	Axles	Drive
S 315 GT-HD	627.251	12 m	2	2	Diesel engine

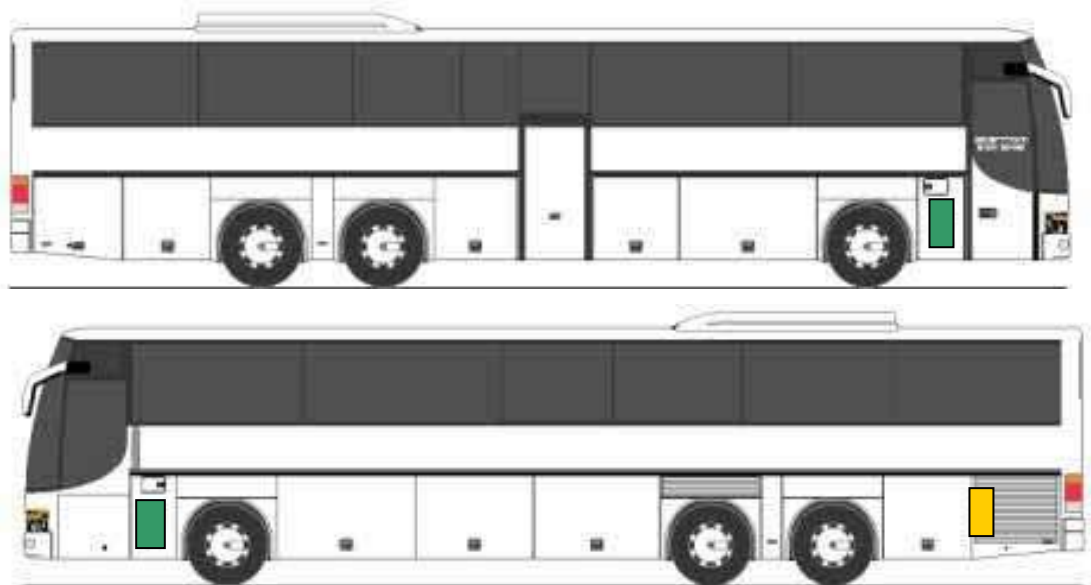

7.4.7 S 317 GT-HD

	Model	Length	Doors	Axles	Drive
S 317 GT-HD	627.271	13.85 m	2	3	Diesel engine



-  Fuel tank
-  Batteries

7.4.8 S 319 GT-HD

	Model	Length	Doors	Axles	Drive
S 319 GT-HD	627.261	14.95 m	2	3	Diesel engine

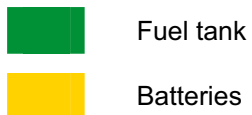
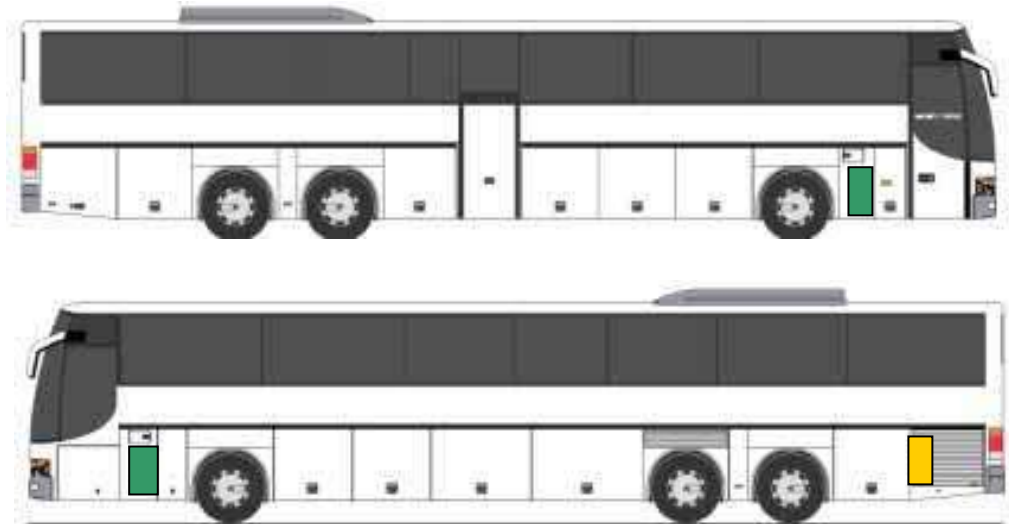

7.4.9 S 411 HD

	Model	Length	Doors	Axles	Drive
S 411 HD	629.410	10.1 m	3	2	Diesel engine

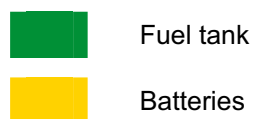

7.4.10 S 415 HD

	Model	Length	Doors	Axles	Drive
S 415 HD	629.411	12.00 m	3	2	Diesel engine

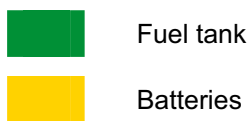
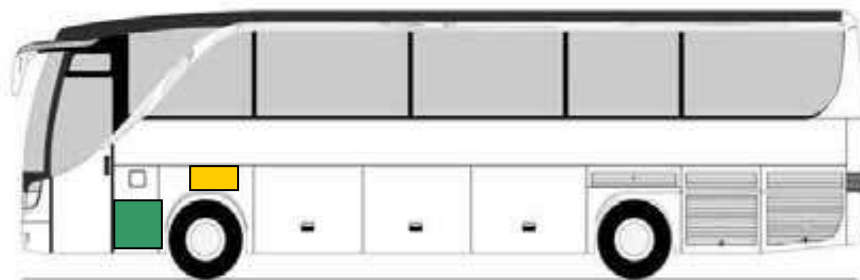
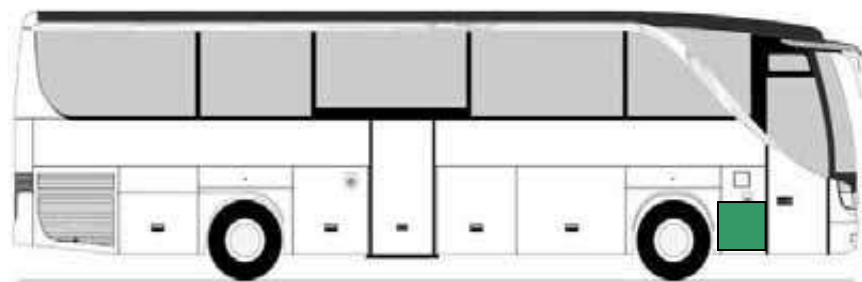

7.4.11 S 415 HDH

	Model	Length	Doors	Axles	Drive
S 415 HDH	629.421	12.00 m	3	2	Diesel engine

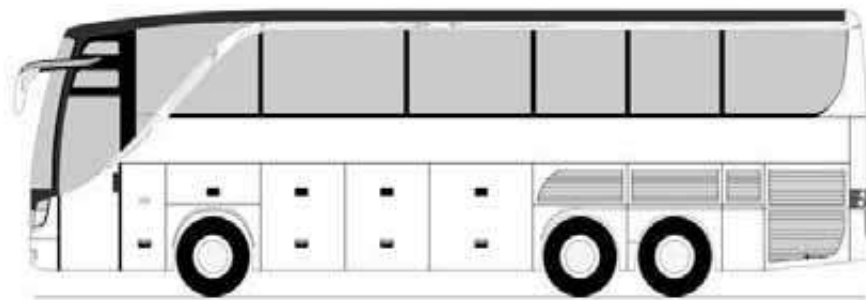
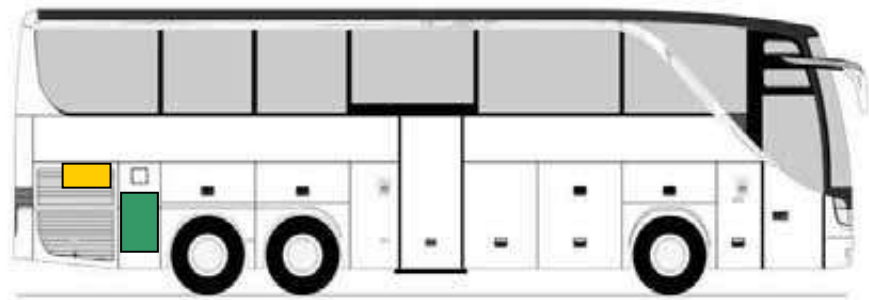

Fuel tank



Batteries

7.4.12 S 416 HDH

	Model	Length	Doors	Axles	Drive
S 416 HDH	629.425	13 m	3	2	Diesel engine

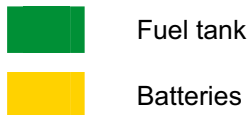
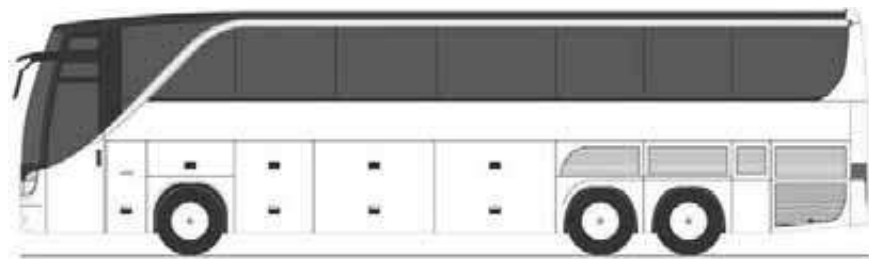
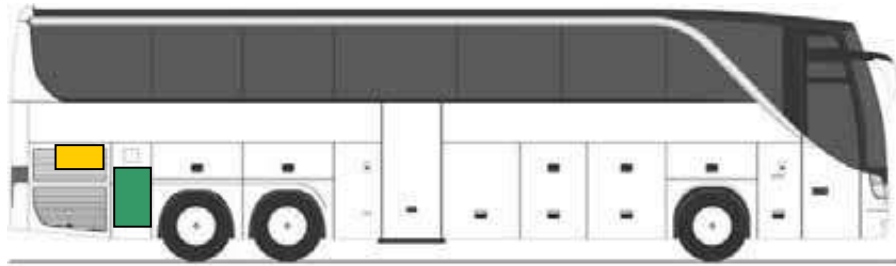

7.4.13 S 417 HDH

	Model	Length	Doors	Axles	Drive
S 417 HDH	629.422	13.85 m	3	2	Diesel engine

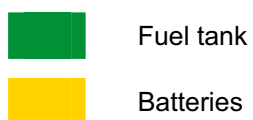
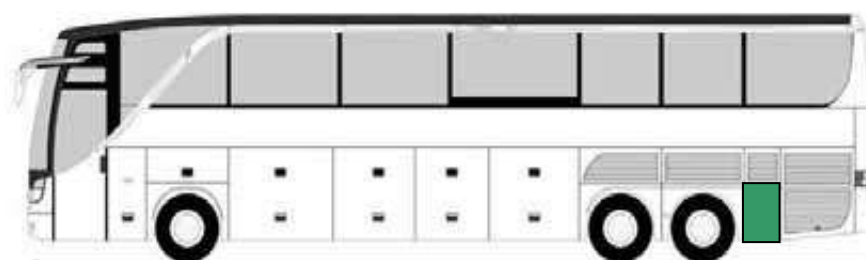
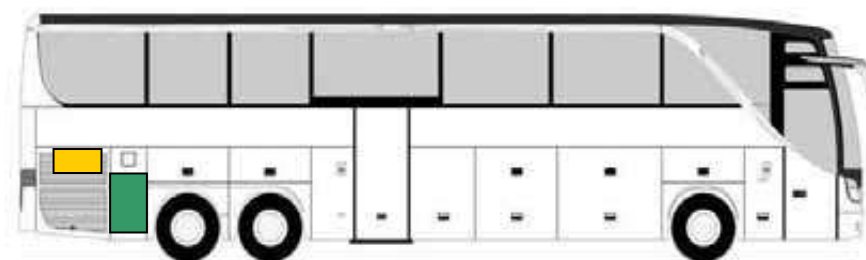

7.4.14 S 431 DT

	Model	Length	Doors	Axles	Drive
S 431 DT	410.001	13.89 m	3	3	Diesel engine

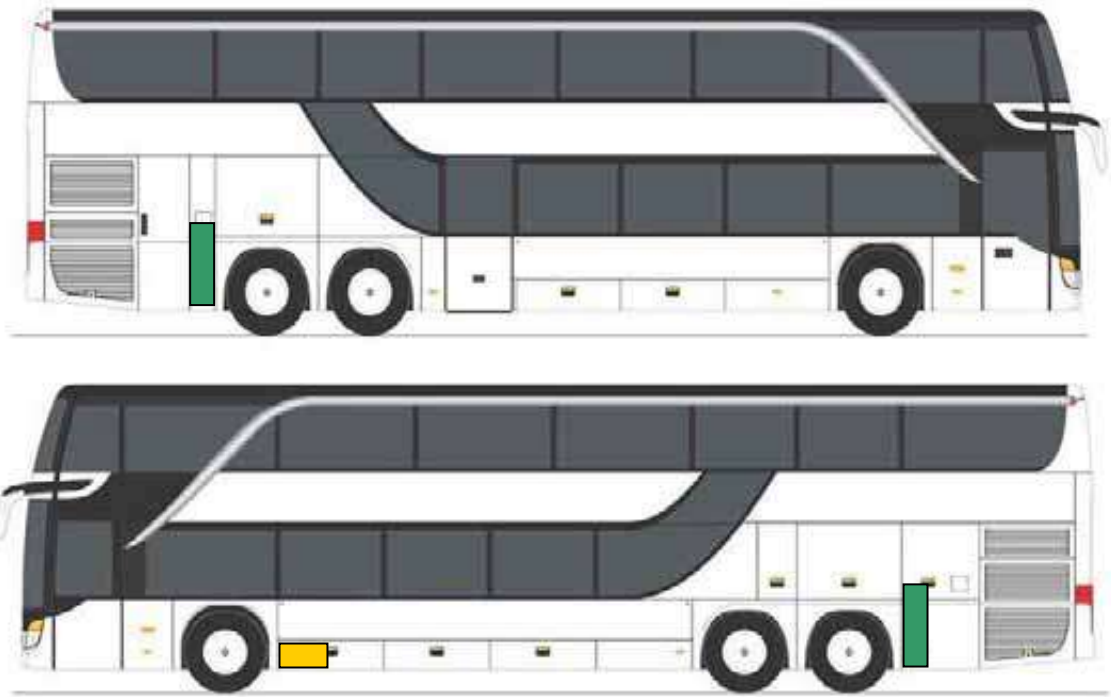

- Fuel tank
- Batteries

Index

A	
Adjustment	
armrest.....	42
backrest.....	43
driver seat.....	40
passenger seat.....	42
steering wheel.....	41
Aluminium.....	15
Annex.....	52
Armrest.....	42
Articulated bus.....	14
B	
Backrest.....	43
Battery.....	17
disconnecting.....	18
S 309 HD.....	72
S 312 HD.....	73
S 313 UL.....	64
S 315 GT.....	76
S 315 GT-HD.....	77
S 315 H.....	63
S 315 HD.....	73
S 315 HDH.....	74
S 315 NF.....	57
S 315 UL.....	65
S 317 GT-HD.....	78
S 317 HDH.....	74
S 319 GT-HD.....	79
S 319 NF.....	58
S 319 UL.....	66
S 328 DT.....	75
S 411 HD.....	80
S 412 UL.....	68
S 415 HD.....	81
S 415 HDH.....	82
S 415 NF.....	59, 60
S 415 UL.....	69
S 416 HDH.....	83
S 416 NF.....	61
S 417 HDH.....	84
S 417 UL.....	70
S 431 DT.....	85
SG 321 UL.....	67
Battery circuit breaker.....	21
Battery trays.....	17
Body frame.....	12
C	
Characteristics.....	50
city bus.....	56
coach.....	71
interurban bus.....	62
City bus.....	56
Classification of buses.....	50
Coach.....	71
Copyright.....	5
Covering the air intake.....	22
Cutting open	
bellows.....	38
D	
Definition of bus.....	50
Diesel drive.....	11
material and capacity of tank.....	11
Dimensions.....	14
Distinguishing characteristics.....	51
city bus.....	51
coach.....	51
interurban bus.....	51
Doors	
buttons.....	31, 34
emergency valve.....	32, 34
hand wheel.....	35
inward folding.....	30
opening from inside.....	34
opening from outside.....	31
outward swinging.....	30
plug-in sliding.....	30
square wrench.....	35
Driver rest area.....	48
Driver seat.....	40
Driver seat adjustment.....	40
Driver's station.....	39
cab door.....	39
driver seat.....	40

E			
Emergency exit	36	Luggage compartment.....	47
opening from inside	36	Luggage rack.....	45
opening from outside.....	36	M	
Emergency valve		Magnesium	15
inside	34	Main isolating switch.....	21
outside	32	Manufacturer.....	54
Endless slings	25	Materials	13, 15
Engine		Medical aspects.....	7
switching off.....	20	Medical care	7
Engine compartment flap	23	Mobile crane	25
F		Model designation	54
Fire detection system	16	Models	
Fire extinguisher system	16	distinguishing characteristics	51
Fire protection	10	identification	52
G		Multiple casualty incident.....	10
Galley	47	P	
H		Partitions.....	45
Handrails	45	Passenger compartment	42
I		Passenger restraint systems	42
Identification of bus model	52	Passenger seat.....	42
manufacturer	54	attachment	43
model designation	54	city bus	44
model plate	52	coach.....	44
variant.....	54	interurban bus	44
variant overview	55	removal	43
Vehicle Identification End Number	54	Publisher's information	4
Vehicle Identification Number (VIN)	54	R	
VIN.....	54	Release.....	7, 16
Ignition lock	20	Rescue	
Immediate measures.....	8	patient-orientated	7
Initial emergency care.....	7	Rescue of persons.....	7
Injecting CO2	22	Roof hatch	36
Interurban bus	62	opening from inside.....	36
J		opening from outside	36
Jack.....	26	S	
K		S 309 HD	72
Kneeling	28	S 312 HD	73
L		S 313 UL.....	64
Laminated safety glass	38	S 315 GT	76
Legal notices	5	S 315 GT-HD.....	77
Liability	5	S 315 H.....	63
Lifting / lowering system.....	28	S 315 HD	73
Lifting the vehicle	26	S 315 HDH.....	74
		S 315 NF.....	57
		S 315 UL.....	65
		S 317 GT-HD	78

S 317 HDH	74	S 315 NF	57
S 319 GT-HD	79	S 315 UL	65
S 319 NF	58	S 317 GT-HD	78
S 319 UL	66	S 317 HDH	74
S 328 DT	75	S 319 GT-HD	79
S 411 HD	80	S 319 NF	58
S 412 UL	68	S 319 UL	66
S 415 HD	81	S 328 DT	75
S 415 HDH	82	S 411 HD	80
S 415 NF	59, 60	S 412 UL	68
S 415 UL	69	S 415 HD	81
S 416 HDH	83	S 415 HDH	82
S 416 NF	61	S 415 NF	59, 60
S 416 UL	69	S 415 UL	69
S 417 HDH	84	S 416 HDH	83
S 417 UL	70	S 416 NF	61
S 419 UL	70	S 416 UL	69
S 431 DT	85	S 417 HDH	84
Seat belt	42	S 417 UL	70
Securing action	24	S 419 UL	70
SG 321 UL	67	S 431 DT	85
Single-pane safety glass	38	SG 321 UL	67
Ski boxes	49	Technical rescue	16
Special areas	46	Toilet cabin	46
driver rest area	48	Trademarks	5
galley	47	Type plate	52
luggage compartment	47	V	
ski boxes	49	Variant	54
Stabilisation	24	Variant overview	55
Start/Stop switch	20	Vehicle body	12
Steering column	41	Vehicle doors	30
Support	24	Vehicle Identification End Number	54
Supporting struts	24	Vehicle Identification Number (VIN)	54
T		VIN (Vehicle Identification Number)	54
Tank		W	
S 309 HD	72	Warranty	5
S 312 HD	73	Weight	14
S 313 UL	64	Wheel chocks	24
S 315 GT	76	Window	38
S 315 GT-HD	77	laminated safety glass	38
S 315 H	63	removing	38
S 315 HD	73	single-pane safety glass	38
S 315 HDH	74	Window glass	see Window